





















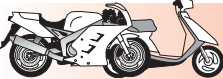





















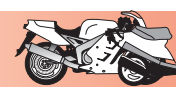



 →  POWER SPORT 	1
 →  POWER SPORT 	151
 →  POWER SPORT 	177
   → 	193
 →   	195
 →   	224
  →  	228
 POWER SPORT  →  	235
  →  	238
  →  	239
  → 	247
  ↔  POWER SPORT 	256
  ↔   	267

**21****POWER
SPORT****ACCOSSATO**

50cc	Enduro Unitrac	1974→	OE074	N5C	0.7	8339	
80cc	CR80 Cross/Enduro		OE040	N2C	0.5	8904	
ACTION							
	Attack Mini Bike	1996→1998	OE086	RL82C	0.7	8814	
	Outback Mini Bike	1996→1998		RL86C	0.7		
	Outlaw Mini Bike	1996→1998	OE086	RL82C	0.7	8814	
	Small Fry Mini Bike	1996→1998		RL86C	0.7		
ADLER							
100cc	Junior MR 100			L78C	0.5	8883	
	M 100			L78C	0.5	8883	
125cc	M 125			L78C	0.5	8883	
150cc	MB 150			L78C	0.5	8883	
200cc	MB 200			L82C	0.5	8814	
	MB 201			L82C	0.5	8814	
250cc	MB 250			L82C	0.5	8814	
	MB 250 Favorit			L78C	0.5	8883	
ADLY							
125cc	Activator	2000→		RZ96C	0.7		
AGRATI GARELLI (→ Garelli)							
AGS							
125cc	Zündapp			L78C	0.5	8883	
AJP							
125cc	Enduro 125	2003→	OE083	RA6HC	0.8	8809	
	Super-Moto 125	2003→	OE083	RA6HC	0.8	8809	
200cc	Enduro 200	2003→	OE083	RA6HC	0.8	8809	
	Super-Moto 200	2003→	OE083	RA6HC	0.8	8809	
250cc	P 250 Cross	2004→		RG94C	0.6	8698	
AJS MATCHLESS (→AMC)							
ALFER							
50cc	GR 30, TX 30			RL78C	0.6	8883	
80cc	MC 80		OE040	N2C	0.5	8904	
125cc	GR 125 ISDE		OE068	N3C	0.5	8904	
	MC 125		OE040	N2C	0.5	8904	
	VRE 125 (4T)		OE092	RG4HC	0.7	8698	
	VRE 125 no limit (4T)		OE092	RG4HC	0.7	8698	
250cc	EGR 250 Agua/Air		OE068	N3C	0.5	8904	
	MC 250		OE040	N2C	0.5	8904	
	VR 250 (2T)		OE108	RN3C	0.8	8904	
	VR 250 no limit Supermoto (2T)		OE108	RN3C	0.8	8904	
300cc	AR-1		OE068	N3C	0.5	8904	
	GR 300 Agua		OE068	N3C	0.5	8904	
	TX 300		OE068	N3C	0.5	8904	
490cc	MC 500		OE040	N2C	0.5	8904	
ALGAT							
	Plico			CJ6	0.5		
ALKRO							
48cc	All models		OE037	L86C	0.5		

**ACCOSSATO**

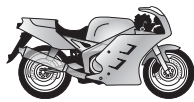
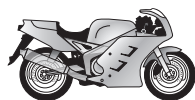

21



POWER SPORT



ALL STATE

Mini Bike M14mm L 12,7mm/1/2in.
 Mini Bike M14mm L 9.5mm/3/8 in.
 Mini Bike M18mm Tapered seat

OE037 L86C 0.5
 RJ8C 0.5
 RF11YC 0.5

AMC

100cc All models L 12,7mm,1/2in.
 All models L 19mm,3/4in.
 Mustang

OE037 L86C 0.5
 RN5C 0.5 8339
 OE086 RL82C 0.5 8814

125cc All models L 12,7mm,1/2in.
 Sport

OE037 L86C 0.5
 OE086 RL82C 0.5 8814

150cc Sport

L77JC4 1.0 8883

175cc Sport
 Sport

OE086 RL82C 0.5 8814
 L77JC4 1.0 8883

250cc A.T. 37
 ACT
 CSR 14
 Sport
 Stormer L 12,7mm,1/2in.
 Stormer L 19mm,3/4in.
 Y4

RN5C 0.5 8339
 OE086 RL82C 0.5 8814
 OE108 RN3C 0.5 8904
 L77JC4 0.4 8883
 L78C 0.5 8883
 OE108 RN3C 0.5 8904
 OE108 RN3C 0.5 8904

350cc All standard singles

OE079 N4C 0.5 8339

370cc Y5

OE108 RN3C 0.5 8904

500cc 18
 CS
 CS 18
 CS 18
 CSR
 G 11
 G 12
 G 15
 G 20
 G 30
 G 31
 G 33
 G 80 CS
 G 80 CS
 G 80 CS
 G 85 CS Central plug
 G 9

OE079 N4C 0.5 8339
 OE068 N3C 0.5 8904
 OE068 N3C 0.5 8904
 C59R 0.5
 OE068 N3C 0.5 8904
 OE079 N4C 0.5 8339
 OE079 N4C 0.5 8339
 OE079 N4C 0.5 8339
 OE079 N4C 0.5 8339
 OE079 N4C 0.5 8339
 OE079 N4C 0.5 8339
 OE079 N4C 0.5 8339
 OE079 N4C 0.5 8339
 OE079 N4C 0.5 8339
 OE068 N3C 0.5 8904
 C59R 0.5
 C59R 0.5
 OE079 N4C 0.5 8339

750cc 33
 CS
 CSR
 CSR 33
 G 11
 G 12
 G 15
 G 20
 G 30
 G 31
 G 33
 G 9

OE098 RN4C 0.5 8339
 OE068 N3C 0.5 8904
 OE098 RN4C 0.5 8339
 OE068 N3C 0.5 8904
 OE079 N4C 0.5 8339
 OE079 N4C 0.5 8339
 OE079 N4C 0.5 8339
 OE079 N4C 0.5 8339
 OE079 N4C 0.5 8339
 OE079 N4C 0.5 8339
 OE079 N4C 0.5 8339
 OE079 N4C 0.5 8339
 OE079 N4C 0.5 8339
 OE079 N4C 0.5 8339

ALL STATE



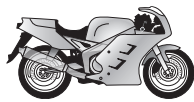

21



POWER
SPORT



AMERICAN EAGLE

150cc	Renegade TRSCR		OE108	RN3C	0.5	8904	
175cc	Wrangler TRSCR			L77JC4	1.0	8883	
250cc	Geronimo MX, Sport			L77JC4	1.0	8883	
350cc	Cheeta			UL81C	0.5	8814	
	Marauder			UL81C	0.5	8814	
	Road Sport			UL81C	0.5	8814	
	Savage			UL81C	0.5	8814	
360cc	Talon			QC59C	0.5		
405cc	Talon MX			QC59C	0.5		
750cc	Classic		OE108	RN3C	0.5	8904	
	Eagle		OE108	RN3C	0.5	8904	
	Super Sport		OE108	RN3C	0.5	8904	

AMERICAN IRON HORSE

1573cc	All models	1999→2002	OE049	RN11YC4	1.0	8405	
1753cc	All models	1999→2003	OE049	RN11YC4	1.0	8405	
1819cc	All models	2004→		RABHC	1.0	8812	
1852cc	All models	1999→2003	OE049	RN11YC4	1.0	8405	
1918cc	All models	2004→		RABHC	1.0	8812	
2033cc	All models	2003→		RABHC	1.0	8812	

AMF HARLEY-DAVIDSON (→ Harley-Davidson)

ANKER

Ankermatic

OE037 L86C 0.5

APRILIA

50cc	AF1			QN84	0.6		PRO-5M	
	AF1 Replica-Futura-Sintesi			QN84	0.6		PRO-5M	
	Classic	1992→	OE108	RN3C	0.6	8904	PRO-5M	
	ET Fire			QN84	0.6		PRO-5M	
	ET Tuareg			QN84	0.6		PRO-5M	
	Europa			QN84	0.6		PRO-5M	
	GL	1993→	OE108	RN3C	0.6	8904	PRO-5M	
	LX	1993→	OE108	RN3C	0.6	8904	PRO-5M	
	RC Normale, Special			OE074	N5C	0.6	8339	PRO-5M
	Red Rose				QN84	0.6		PRO-5M
	RG Stealth (Liquid cooled)	1997→			RL78C	0.6	8883	
	RS50 (PG)			OE091	RN2C	0.6	8904	PRO-5M
	RS50 (SE)			OE091	RN2C	0.6	8904	PRO-5M
	RS50 Extrema (Liquid cooled)			OE040	N2C		8904	PRO-5M
	RS50 Racing Replica			OE064	RL82YC	0.6	8814	PRO-5M
	RX			OE091	RN2C	0.6	8904	PRO-5M
	Strada				QN84	0.6		PRO-5M
Tuareg				QN84	0.6		PRO-5M	
125cc	AF1 Replica			QN84	0.6		PRO-5M	
	AF1 Sport			QN84	0.6		PRO-5M	
	AS125 R		OE091	RN2C	0.6	8904		
	Classic			QN84	0.6			
	Climber		OE015	N12YC	0.8	8405		
	ETX Tuareg		OE091	RN2C	0.6	8904	PRO-5M	
	Europa Replica			QN84	0.6			
	Futura Sport Production			QN84	0.6			
	MX	2004→	OE091	RN2C	0.6	8904		
	Pegaso RX			QN84	0.6		PRO-5M	

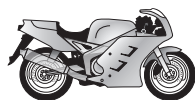

**21****POWER
SPORT****...APRILIA**

Capacity	Model	Year	Part No.	Gap (mm)	Part No.	Part No.
...125cc	Red Rose		QN84	0.6		PRO-5M
	RS (Liquid cooled)	1993→	C55CX	0.5		
	RS Extrema	1995→	QN84	0.5		
	RS Racing Replica	1993→1996	QN84	0.6		
	RX		QN84	0.6		PRO-5M
	Sintesi Sport		QN84	0.6		PRO-5M
	Sport Pro		QN84	0.6		
	ST	1982→	QN84	0.5		
	Strada		OE091 RN2C	0.6	8904	
	Strada R		OE091 RN2C	0.6	8904	
	STX	1982→	QN84	0.5		
	Tuareg, Rally, Wind		QN84	0.6		PRO-5M
150cc	Atlantic 150	2003→	OE092 RG4HC	0.6	8698	
240cc	Trials	1985→1993	OE065 N11YC	0.8	8405	
	TX	1985→1993	OE065 N11YC	0.8	8405	
250cc	Cross		QN84	0.6		
	GP		QN84	0.5		
	RS250 Racing Replica (Liquid cooled)		QN84	0.6		
	RX		OE091 RN2C	0.6	8904	
	Tuareg Rally		QN84	0.6		
280cc	Climber R Trials		OE015 N12YC	0.8	8405	
	Climber Trials		OE015 N12YC	0.8	8405	
	TX 300, 311, TXR 312		OE015 N12YC	0.8	8405	
320cc	TL		OE015 N12YC	0.5	8405	
	TR		QN84	0.6		
350cc	ETX	1986→1993	OE083 RA6HC	0.5	8809	
	EXT	1985→	OE083 RA6HC	0.5	8809	
	Tuareg Wind	1986→1993	OE083 RA6HC	0.5	8809	
450cc	RXV Enduro (VP)	2006→	RG94C	0.6	8698	
	RXV Supermoto (VP)	2006→	RG94C	0.6	8698	
	SXV Supermoto (VS)	2006→	RG94C	0.6	8698	
550cc	RXV Enduro (VP)	2006→	RG94C	0.6	8698	
	RXV Supermoto (VP)	2006→	RG94C	0.6	8698	
	SXV Supermoto (VS)	2006→	RG94C	0.6	8698	
	SXV Van Den Bosch Replica	2007→	RG94C	0.6	8698	
600cc	Pegaso	1986→1993	OE083 RA6HC	0.6	8809	
	Tuareg 600 Wind	1987→1992	OE083 RA6HC	0.6	8809	
650cc	Moto 6.5 Starck	1995→	OE083 RA6HC	0.7	8809	
	Pegaso i.e. / Cube / Garda	1994→2000	OE083 RA6HC	0.6	8809	
	Pegaso MX, /ML Yamaha MT-03	2001→2004	RAX92C	0.5	8809	
	Pegaso Strada	2005→	RG96C	0.7	8698	
	Pegaso Trail	2006→	RG96C	0.6	8698	
1000cc	ETV Capo Nord	2001→2003	OE073 RA4HC	0.6		
	ETV Capo Nord	2004→2005	OE073 RA4HC	0.6		
	RST Futura	2001→2003	OE073 RA4HC	0.6		
	RSV	2006→	OE073 RA4HC	0.6		
	RSV (MEA) (Twin Spark)	1998→2000	OE073 RA4HC	0.6		
	RSV (MED)	1999→2001	G54V			
	RSV (RP)	1999→2001	OE073 RA4HC	0.6		
	RSV R (RR)	2003→	OE073 RA4HC	0.6		
	RSV R Factory	2003→2004	OE073 RA4HC	0.6		
	RSV R Nera	2004→	OE073 RA4HC	0.6		
	RSV SP	2003→	OE073 RA4HC	0.6		
	RSV Tuono (RR)	2004→	OE073 RA4HC	0.6		

APRILIA

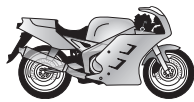
**21****POWER SPORT****...APRILIA****...1000cc**

SL Falco	2000 → 2003	OE073	RA4HC	0.6	
Tuono (RP)	2006 →	OE073	RA4HC	0.6	
Tuono Fighter	2003 →	OE073	RA4HC	0.6	
Tuono Fighter R	2003 →	OE073	RA4HC	0.6	

ARCTIC CAT**375cc**

2x4	2002 →		RG96C	0.8	8698
4x4	2002 →		RG96C	0.8	8698

ARIEL**250cc**

Arrow		OE079	N4C	0.5	8339
Leader models		OE079	N4C	0.5	8339

350cc

NG Red Hunter	→ 1955		L82C	0.5	8814
NH Red Hunter	1956 → 1959	OE079	N4C	0.5	8339
NH Red Hunter	→ 1955		L82C	0.5	8814

500cc

HS		OE079	N4C	0.5	8339
KG	→ 1952		L82C	0.5	8814
KH	1953 → 1959	OE074	N5C	0.5	8339
KH	→ 1952		L82C	0.5	8814
KHA	1953 → 1959	OE074	N5C	0.5	8339
S.V. models (18mm plug)			D16	0.5	
VCA	1953 → 1959	OE074	N5C	0.5	8339
VG	→ 1952		L82C	0.5	8814
VH	→ 1952		L82C	0.5	8814
VH Hunter	1953 → 1959	OE074	N5C	0.5	8339
VHA	1953 → 1959	OE074	N5C	0.5	8339

600cc

VB	1952 → 1954	OE074	N5C	0.5	8339
VB	1955 → 1959	OE074	N5C	0.5	8339

650cc

FH Huntmaster	1954 → 1959		L82C	0.5	8814
---------------	-------------	--	------	-----	-------------

1000cc

Square Four	1953 → 1959	OE074	N5C	0.5	8339
Square Four	→ 1952		L82C	0.5	8814

ARM**125cc**

Cross			QN84	0.5	
Velocidad Enduro		OE091	RN2C	0.5	8904

250cc

Velocidad Enduro / Cross		OE091	RN2C	0.5	8904
--------------------------	--	--------------	------	-----	-------------

350cc

Enduro		OE091	RN2C	0.5	8904
--------	--	--------------	------	-----	-------------

ASPES**50cc**

Mini Sioux		OE037	L86C	0.6	
Navaho			RN5C	0.6	8339
Navaho RCR, CRC		OE091	RN2C	0.6	8904
Scrambler		OE037	L86C	0.6	
Sioux KS, KSL		OE037	L86C	0.6	

125cc

CRC 80			QN84	0.6	
Cross Hopi models			QN84	0.6	
Cross RG Hopi models			QN84	0.6	
CRS			QN84	0.6	
Juma		OE091	RN2C	0.6	8904
Monoscocca		OE091	RN2C	0.6	8904
Regolarità Hopi models			QN84	0.6	
RG			QN84	0.6	
RGC			QN84	0.6	
RGCR 80			QN84	0.6	
RGEL			QN84	0.6	
RGL			QN84	0.6	
RGS			QN84	0.6	
TSB		OE091	RN2C	0.6	8904

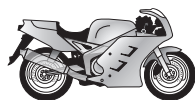

**21****POWER SPORT****AT MOTO**

50cc	S 3800 (Velo Solex)		OE037	L86C	0.6		
-------------	---------------------	--	--------------	------	-----	--	--

ATK

50cc	50 MX (2-Stroke)	1999 → 2003		RL78C	0.6	8883	
	50 MXLQ	2003 →		QC57	0.6		
	50 MXR (2-Stroke)	2001 → 2003		RL78C	0.6	8883	
	Mini Cross Country, MX (2-Stroke)	1999 → 2001		RL78C	0.6	8883	

125cc	125 LQ Enduro Liquid Cooled (4-Stroke)	2003 →	OE083	RA6HC	0.6	8809	
	MX (2-Stroke)	1999 → 2001	OE091	RN2C	0.6	8904	

249cc	250 Cross Country Liquid Cooled (2-Stroke)	1995 → 2002	OE091	RN2C	0.6	8904	
--------------	--	-------------	--------------	------	-----	-------------	--

250cc	250 Cross Country, MX Air Cooled (2-Stroke)	1989 → 1996	OE091	RN2C	0.6	8904	
--------------	---	-------------	--------------	------	-----	-------------	--

260cc	260 Cross Country Liquid Cooled (2-Stroke)	1995 → 2003	OE091	RN2C	0.6	8904	
--------------	--	-------------	--------------	------	-----	-------------	--

348cc	350 Cross Country, Enduro (4-Stroke)	1991 → 2002	OE083	RA6HC	0.6	8809	
--------------	--------------------------------------	-------------	--------------	-------	-----	-------------	--

406cc	406 Cross Country, MX (2-Stroke)	1988 → 1996	OE091	RN2C	0.6	8904	
--------------	----------------------------------	-------------	--------------	------	-----	-------------	--

494cc	490 Cross Country, Enduro (4-Stroke)	1999 → 2002	OE083	RA6HC	0.6	8809	
--------------	--------------------------------------	-------------	--------------	-------	-----	-------------	--

	500 DTE Dirt Track (4-Stroke)	1999 → 2002	OE083	RA6HC	0.6	8809	
--	-------------------------------	-------------	--------------	-------	-----	-------------	--

	500 Motard (4-Stroke)	1999 → 2002	OE083	RA6HC	0.6	8809	
--	-----------------------	-------------	--------------	-------	-----	-------------	--

500cc	Dirt Track (4-Stroke)	1999 → 2003	OE083	RA6HC	0.6	8809	
--------------	-----------------------	-------------	--------------	-------	-----	-------------	--

	Enduro (4-Stroke)	1998 → 2003	OE083	RA6HC	0.6	8809	
--	-------------------	-------------	--------------	-------	-----	-------------	--

	Supermot / Supermotard (4-Stroke)	2001 →	OE083	RA6HC	0.6	8809	
--	-----------------------------------	--------	--------------	-------	-----	-------------	--

560cc	604 Cross Country, MX (4-Stroke)	1988 → 1992	OE083	RA6HC	0.6	8809	
--------------	----------------------------------	-------------	--------------	-------	-----	-------------	--

600cc	605 Cross / Cross Country / DT / Enduro (4-Stroke)	1993 →	OE083	RA6HC	0.6	8809	
--------------	--	--------	--------------	-------	-----	-------------	--

	Dirt Track (4-Stroke)	1998 → 2003	OE083	RA6HC	0.6	8809	
--	-----------------------	-------------	--------------	-------	-----	-------------	--

	Supermot (4-Stroke)	2001 → 2002	OE083	RA6HC	0.6	8809	
--	---------------------	-------------	--------------	-------	-----	-------------	--

	Supermotard (4-Stroke)	2003 →	OE092	RG4HC	0.8	8698	
--	------------------------	--------	--------------	-------	-----	-------------	--

	Supermotard (4-Stroke)	2001 → 2002	OE083	RA6HC	0.6	8809	
--	------------------------	-------------	--------------	-------	-----	-------------	--

AVELLO (→ Puch)**AVIAN**

125cc	RM (Tau Motor)		OE040	N2C	0.5	8904	
--------------	----------------	--	--------------	-----	-----	-------------	--

250cc	RM (Tau Motor)		OE068	N3C	0.5	8904	
--------------	----------------	--	--------------	-----	-----	-------------	--

AWO

425cc	425 T	1956 →		L82C	0.5	8814	
--------------	-------	--------	--	------	-----	-------------	--

BAJAJ

50cc	Bonnie (195 Alum head)		OE037	L86C	0.6		
-------------	------------------------	--	--------------	------	-----	--	--

100cc	KB (Air cooled)		OE068	N3C		8904	
--------------	-----------------	--	--------------	-----	--	-------------	--

	PLATINA	2008 →	OE059	L92YC			
--	---------	--------	--------------	-------	--	--	--

125cc	XCD DTS-Si 125 Primary+Secondary Plug (Twinspark Swirl Induction)	2008 →	OE092	RG4HC		8698	
--------------	---	--------	--------------	-------	--	-------------	--

135cc	DISCOVER DTS-i Primary+Secondary Plug (Twinspark)	2008 →	OE092	RG4HC		8698	
--------------	---	--------	--------------	-------	--	-------------	--

150cc	PULSAR DTS-i Primary+Secondary Plug (Twinspark)	2008 →	OE092	RG4HC		8698	
--------------	---	--------	--------------	-------	--	-------------	--

180cc	PULSAR DTS-i Primary+Secondary Plug (Twinspark)	2008 →	OE092	RG4HC		8698	
--------------	---	--------	--------------	-------	--	-------------	--

200cc	AVENGER DTS-i Primary+Secondary Plug (Twinspark)	2008 →	OE092	RG4HC		8698	
--------------	--	--------	--------------	-------	--	-------------	--

	PULSAR DTS-i Primary+Secondary Plug (Twinspark)	2008 →	OE092	RG4HC		8698	
--	---	--------	--------------	-------	--	-------------	--

220cc	PULSAR DTS-Fi Primary Plug (Twinspark Fuel Injection)	2008 →	OE092	RG4HC		8698	
--------------	---	--------	--------------	-------	--	-------------	--

	PULSAR DTS-Fi Secondary Plug (Twinspark Fuel Injection)	2008 →	OE122	RG4PHP		8698	
--	---	--------	--------------	--------	--	-------------	--

BAOTIAN

49cc	BR49QT			Z9Y			
-------------	--------	--	--	-----	--	--	--

50cc	BT50QT			Z9Y			
-------------	--------	--	--	-----	--	--	--

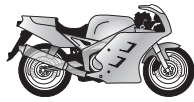
**21****POWER
SPORT****BATAVUS****50cc**

Batavette		OE037	L86C	0.5		
Bronco		OE037	L86C	0.5		
City		OE037	L86C	0.5		
Compact		OE037	L86C	0.5		
G		OE037	L86C	0.5		
Go-Go 2		OE037	L86C	0.5		
Go-Go Super VA		OE037	L86C	0.5		
Go-Go V		OE037	L86C	0.5		
HS		OE037	L86C	0.5		
M40		OE037	L86C	0.5		
Mark 4S			L78C	0.5	8883	
Mosquito		OE037	L86C	0.5		
Pronto 'S'		OE037	L86C	0.5		
Starglo		OE037	L86C	0.5		
Transport JLO FM48		OE037	L86C	0.5		
TS 49			L78C	0.5	8883	
TS 49 S		OE037	L86C	0.5		

BELGARDA**125cc**

DT / TDR / TZR (Yamaha)		OE040	N2C	0.5	8904	
TZR 125 R S/P (Yamaha)		OE040	N2C	0.5	8904	

BENELLI**50cc**

Bobo			RN5C	0.5	8339	
Caddy			RN5C	0.5	8339	
City Bike		OE098	RN4C	0.5	8339	
Cross		OE074	N5C	0.5	8339	
Devil		OE040	N2C	0.5	8904	
Export 3VK		OE074	N5C	0.5	8339	
Export 3VNT		OE074	N5C	0.5	8339	
Export FA		OE074	N5C	0.5	8339	
Fireball		OE098	RN4C	0.5	8339	
Fireball		OE098	RN4C	0.5	8339	
G2 Elle		OE074	N5C	0.5	8339	
Gentleman		OE074	N5C	0.5	8339	
GT 491 (Liquid cooled) Minarelli	1997→		RL78C	0.5	8883	
Magnum 3V, 5V		OE074	N5C	0.5	8339	
Mini Bike		OE098	RN4C	0.5	8339	
Mofa		OE098	RN4C	0.5	8339	
Monaco		OE098	RN4C	0.5	8339	
Motor Ella		OE074	N5C	0.5	8339	
Nibbio		OE098	RN4C	0.5	8339	
Sport 491 Racing (Liquid cooled) Minarelli	1997→		RL78C	0.5	8883	
Sport 491 Strada (Liquid cooled) Minarelli	1997→		RL78C	0.5	8883	
Spring		OE040	N2C	0.5	8904	
Turismo		OE074	N5C	0.5	8339	

125cc

124			Z6	0.5		
2C E		OE108	RN3C	0.5	8904	
2C E Sport		OE108	RN3C	0.5	8904	
2T 125SV		OE108	RN3C	0.5	8904	
BX		OE091	RN2C	0.6	8904	
Cross		OE108	RN3C	0.5	8904	
El Diablo		OE108	RN3C	0.5	8904	
Enduro		OE108	RN3C	0.5	8904	
Jarno			QN84	0.5		

**BENELLI**

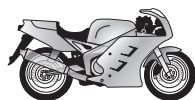
**21****POWER SPORT****...BENELLI**

...125cc	Leoncino C, CE		OE108	RN3C	0.5	8904	
	Leoncino Cross		OE108	RN3C	0.5	8904	
	Olimpia		OE108	RN3C	0.5	8904	
	S			L82C	0.5	8814	
	Sport Special		OE108	RN3C	0.5	8904	
	Sprite 4,5		OE108	RN3C	0.5	8904	
	Sprite Calif.		OE108	RN3C	0.5	8904	
	Turismo		OE108	RN3C	0.5	8904	
230cc	304			Z6	0.5		
250cc	45		OE108	RN3C	0.5	8904	
	2 CE		OE108	RN3C	0.5	8904	
	254 Sport			Z6	0.5		
	2C		OE108	RN3C	0.5	8904	
	Barracuda		OE108	RN3C	0.5	8904	
	El Diablo		OE108	RN3C	0.5	8904	
	Speed Calif.		OE108	RN3C	0.5	8904	
	Sport Special		OE108	RN3C	0.5	8904	
	Sprite		OE108	RN3C	0.5	8904	
	Super Sport		OE108	RN3C	0.5	8904	
	TS		OE108	RN3C	0.5	8904	
350cc	RS		OE083	RA6HC	0.5	8809	
	Sport 354		OE083	RA6HC	0.5	8809	
	Turismo 354		OE083	RA6HC	0.5	8809	
500cc	LS		OE083	RA6HC	0.5	8809	
	Quattro		OE083	RA6HC	0.5	8809	
	Sport 504		OE083	RA6HC	0.5	8809	
650cc	4C		OE083	RA6HC	0.5	8809	
	Sport 654		OE083	RA6HC	0.5	8809	
	T654		OE083	RA6HC	0.5	8809	
	Tornado		OE098	RN4C	0.5	8339	
750cc	Sei		OE083	RA6HC	0.5	8809	
900cc	900 L.E.	2002 →	OE092	RG4HC		8698	
	Sei	1979 →	OE083	RA6HC	0.6	8809	
	Tornado 900	2001 → 2002	OE092	RG4HC		8698	
	Tornado 900 / Biposto	2002 → 2003	OE092	RG4HC		8698	
	Tornado 900 Tre	2005 →	OE092	RG4HC		8698	
	Tornado 900 Tre RS	2004 →	OE092	RG4HC		8698	
1130cc	TNT 1130	2004 →	OE092	RG4HC	0.6	8698	
	TNT 1130 Cafe Racer Sport	2006 →	OE092	RG4HC	0.6	8698	
	TNT 1130, Sport	2006 →	OE092	RG4HC	0.6	8698	

BETA

50cc	2M Special		OE098	RN4C	0.5	8339	
	2VA.SV		OE108	RN3C	0.5	8904	
	4M		OE037	L86C	0.5		
	502 CH	1996 →	OE086	RL82C	0.5	8814	
	5M		OE086	RL82C	0.5	8814	
	AE 19mm, 3/4in.			RN5C	0.5	8339	
	Alp		OE108	RN3C	0.5	8904	
	Andy, G			RN5C	0.5	8339	
	B12 12,7mm, 1/2in.		OE037	L86C	0.5		
	B12 19mm/3/4in.			RN5C	0.5	8339	
	Bambi		OE037	L86C	0.5		
	C40 R		OE086	RL82C	0.5	8814	
	C402 12,7mm, 1/2in.		OE037	L86C	0.5		

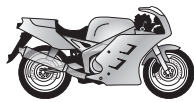
**21****POWER SPORT****...BETA****...50cc**

C402 19mm/3/4in.			RN5C	0.5	8339	
Camoscio		OE086	RL82C	0.5	8814	
CILO 2WA svizzera catalizzato		OE074	N5C	0.6	8339	
CR4		OE086	RL82C	0.5	8814	
CR40		OE086	RL82C	0.5	8814	
Cross, Special		OE086	RL82C	0.5	8814	
FABO			RN5C	0.5	8339	
Four		OE108	RN3C	0.5	8904	
Four AE		OE108	RN3C	0.5	8904	
Four Base, ES, WS		OE108	RN3C	0.5	8904	
Four RV		OE108	RN3C	0.5	8904	
Four XP		OE108	RN3C	0.5	8904	
Holly, TT		OE037	L86C	0.5		
KR		OE108	RN3C	0.5	8904	
M1		OE098	RN4C	0.5	8339	
M1		OE037	L86C	0.5		
M10			RN5C	0.5	8339	
M2		OE098	RN4C	0.5	8339	
M4		OE098	RN4C	0.5	8339	
M4		OE037	L86C	0.5		
M4, Special			RN5C	0.5	8339	
M5, Special			RN5C	0.5	8339	
M6 19mm, 3/4in.		OE098	RN4C	0.5	8339	
MIO		OE098	RN4C	0.5	8339	
MIO L2			RN5C	0.5	8339	
MIO SL			RN5C	0.5	8339	
MIO Special, 2M			RN5C	0.5	8339	
MIO Special, Special 2M		OE108	RN3C	0.5	8904	
MIO VAR	1982 →		RN5C	0.5	8339	
Minicross 12", 15" (Air cooled)	2000 →		RL78C	0.5	8883	
Minimaxi (CILO mot.)		OE037	L86C	0.5		
MX 4 12,7mm, 1/2in.		OE086	RL82C	0.5	8814	
MX 4 19mm, 3/4in.		OE098	RN4C	0.5	8339	
MX 4 Special		OE037	L86C	0.5		
MX 5 12,7mm, 1/2in.		OE086	RL82C	0.5	8814	
MX 5 19mm, 3/4in.		OE108	RN3C	0.5	8904	
MX 6 12,7mm, 1/2in.		OE037	L86C	0.5		
MX 6 19mm, 3/4in.			RN5C	0.5	8339	
MX 6 E		OE086	RL82C	0.5	8814	
MX Enduro		OE091	RN2C	0.5	8904	
Nemo (Liquid cooled)		OE010	N7YC	0.5	8332	
Pro Race			N1C		8904	
Pullman 12,7mm, 1/2in.		OE037	L86C	0.5		
Pullman 19mm/3/4in.			RN5C	0.5	8339	
Pullman Special			RN5C	0.5	8339	
RK6		OE091	RN2C	0.5	8904	
RR Supermoto (Liquid cooled)	1999 →		RN1C	0.5	8904	
RX		OE098	RN4C	0.5	8339	
S1		OE098	RN4C	0.5	8339	
S2		OE098	RN4C	0.5	8339	
Scrambler		OE108	RN3C	0.5	8904	
SL5		OE037	L86C	0.5		
Special		OE098	RN4C	0.5	8339	
Squirrel		OE108	RN3C	0.5	8904	

**BETA**

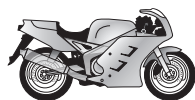
**21****POWER
SPORT****...BETA**

...50cc	Super Trial		RN1C	0.5	8904
	Supermotard		RN1C	0.5	8904
	Techno		OE108 RN3C	0.5	8904
	TR		RN5C	0.5	8339
	TR		OE108 RN3C	0.5	8904
	TR 19mm/3/4in.		OE098 RN4C	0.5	8339
	TR34		OE108 RN3C	0.5	8904
	TR35		OE108 RN3C	0.5	8904
	TR52		OE108 RN3C	0.5	8904
	TR6		OE037 L86C	0.5	
	TR84		OE098 RN4C	0.5	8339
	TR86 19mm/3/4in.		RN5C	0.5	8339
	Trasporto		RN5C	0.5	8339
	Tubon (Electric start)		OE108 RN3C	0.5	8904
	VAR AE, SL		RN5C	0.5	8339
	Zero		OE091 RN2C	0.5	8904
72cc	RR Supermoto (Liquid cooled)	2000 →	RN5C	0.5	8339
125cc	6V		L78C	0.5	8883
	Afrika		OE108 RN3C	0.5	8904
	CR A		QN84	0.5	
	CR RV		QN84	0.5	
	Custom		OE108 RN3C	0.5	8904
	E6		OE086 RL82C	0.5	8814
	ES		L78C	0.5	8883
	Euro (Air cooled)	2000 →	OE083 RA6HC		8809
	G6		L78C	0.5	8883
	KR		OE108 RN3C	0.5	8904
	RC		QN84	0.5	
	RCE		RN5C	0.5	8339
	RCRV		QN84	0.5	
	RV		QN84	0.5	
	RX /A		OE108 RN3C	0.5	8904
	Scrambler		OE108 RN3C	0.5	8904
	SG		L78C	0.5	8883
	SYNT		OE091 RN2C	0.6	8904
	T		RN5C	0.5	8339
	Techno		OE010 N7YC	0.5	8332
	TR32		RN5C	0.5	8339
	TR33		RN5C	0.5	8339
	TR34		OE108 RN3C	0.5	8904
	TR35		OE108 RN3C	0.5	8904
	Trial		RN5C	0.5	8339
	TS		RN5C	0.5	8339
	Zero		OE040 N2C	0.5	8904
200cc	Alp 4T (Air cooled) (Suzuki)	2000 →	OE083 RA6HC	0.9	8809
240cc	Alp (Liquid cooled)		OE108 RN3C	0.5	8904
	Super Trial		OE108 RN3C	0.5	8904
	TR33		OE079 N4C		8339
	TR34		OE108 RN3C	0.5	8904
	TR35		OE108 RN3C	0.5	8904
	Zero		OE108 RN3C	0.5	8904

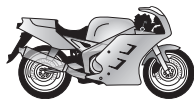
**21****POWER
SPORT****...BETA**

250cc	Afrika		OE108	RN3C	0.5	8904
	Alp (Liquid cooled)		OE010	N7YC	0.8	8332
	CR 240			QN84	0.5	
	Custom 240			QN84	0.5	
	GS			QN84	0.5	
	KR (Air cooled)		OE108	RN3C	0.5	8904
	RX		OE108	RN3C	0.5	8904
	Techno	1995 →	OE010	N7YC	0.5	8332
	Techno		OE075	C6YCC	0.5	
	TR32			RN5C	0.5	8339
	TR33			RN5C	0.5	8339
Trial 240			RN5C	0.5	8339	
260cc	Alp (Liquid cooled)		OE108	RN3C	0.5	8904
	Synt ST		OE108	RN3C	0.5	8904
	TR34 , Replica		OE108	RN3C	0.5	8904
	TR35		OE108	RN3C	0.5	8904
	Zero		OE108	RN3C	0.5	8904
350cc	Alp 4.0 Suzuki		OE092	RG4HC		8698
	CR Alum head			QN84	0.5	
	Euro Alum head	2001 →	OE092	RG4HC		8698
	GS Alum head			QN84	0.5	
	Jonathan Alum head		OE092	RG4HC		8698
	M4 4T Alum head		OE092	RG4HC		8698
Motard 4.0		OE092	RG4HC		8698	
500cc	CR			QN84	0.5	
	KTM CR 60, 65, 70			C55	0.5	

BIG DOG

1310cc	All models		OE049	RN11YC4	1.0	8405
1440cc	All models		OE049	RN11YC4	1.0	8405
1570cc	All models		OE049	RN11YC4	1.0	8405
1750cc	S&S engine		OE049	RN11YC4	1.0	8405
	Total Performance engine			RA8HC		8812
1918cc	S&S engine			RA8HC		8812

BIMOTA

50cc	Bellaria			G59C	0.6	8698
	Tesi 1D	→1995	OE103	A59GC	0.6	
	YB8 Dieci	→1995	OE103	A59GC	0.6	
500cc	V-Due	1997 →	OE091	RN2C	0.7	8904
600cc	YB9 Bellaria	→1995	OE092	RG4HC	0.7	8698
	YB9 SR (FZR 600)	1995 →2001	OE092	RG4HC	0.7	8698
	YB9 SR i (Yamaha Mot.FZR 600)	1996 →2001		G57C	0.6	8654
650cc	Biposto (BMW mot.)	1994 →2000	OE073	RA4HC	0.6	
	Supermono	1994 →2000	OE073	RA4HC	0.6	
750cc	DB1		OE038	L82YC	0.6	8814
	SB7 (GSX Suzuki mot.)	1993 →		RA2HC	0.6	
	YB4		OE083	RA6HC	0.7	8809
851cc	Tesi 1	1992 →	OE073	RA4HC	0.6	
900cc	DB2 (Injection) (Ducati V2)	1992 →1999	OE083	RA6HC	0.6	8809
	DB2 SR	1992 →	OE083	RA6HC	0.6	8809
	DB4	1998 →	OE083	RA6HC	0.6	8809
904cc	Mantra (Ducati 900 mot.)	→1995	OE083	RA6HC	0.6	8809
906cc	DB1 ES, SR	1994 →	OE083	RA6HC	0.6	8809
996cc	S88 R (Suzuki Motor)	1998 →2003	OE092	RG4HC		8698
	S88 R/Special (Suzuki Motor)	2000 →2004	OE092	RG4HC		8698

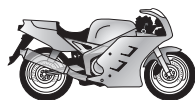
**21****POWER SPORT****...BIMOTA**

1000cc	DB 5 (Ducati Motor)	2005 →	OE052	RA4HCX	0.6		
	DB 6 (Ducati Motor)	2006 →	OE052	RA4HCX	0.6		
	SB8K Santamonica (Suzuki Motor)	2005 →	OE092	RG4HC		8698	
	Tesi 2D 991 (Ducati Motor)	2005 →	OE052	RA4HCX	0.6		
	YB10 Diece Biposto, Furano (Yamaha Mot.)	1993 →	OE083	RA6HC	0.7	8809	
	YB11 Superleggera (Yamaha Mot. FZR 1000)	1996 →2002		RAX92C	0.6	8809	
	YB6			RAX92C	0.7	8809	
	YB8 EXUP	1995 →		RAX92C	0.7	8809	

1100cc	SB 6 R (Suzuki Motor)	1996 →2002	OE092	RG4HC		8698	
	SB6 (Suzuki)	1996 →	OE103	A59GC	0.6		
	SB6 R (GSX Suzuki mot.)	→1995	OE103	A59GC	0.6		

1150cc	SB5 ,S		OE083	RA6HC		8809	
---------------	--------	--	--------------	-------	--	------	--

1200cc	YB5		OE083	RA6HC		8809	
---------------	-----	--	--------------	-------	--	------	--

BLATA

40cc	Elite 13 / 13W		OE040	N2C		8904	
	Elite 13R / 13S / 13WR / 13WRS		OE125	N2G		8904	
	Mini Bike 2.5 w			RL86C	0.7		

BM

49cc	Automatic SA		OE037	L86C	0.6		
	Giromat		OE098	RN4C	0.6	8339	
	Sport		OE086	RL82C	0.6	8814	

BMW

192cc	R 20	1937 →1938	OE037	L86C			
	R 23	1938 →1940	OE037	L86C			

250cc	R 24	1948 →1950		L78C		8883	
	R 25, 25/2, 25/3	1950 →1956		L78C		8883	
	R 26	1956 →1960		L78C		8883	
	R 27	1960 →1967		L78C		8883	
	R 51/2, 51/3	1950 →1954		L78C		8883	

305cc	R 3	1936 →1936	OE037	L86C			
--------------	-----	------------	--------------	------	--	--	--

475cc	R 45	1978 →1985	OE010	N7YC	0.6	8332	PRO-5M
--------------	------	------------	--------------	------	-----	------	--------

494cc	R 5	1936 →1937		L82C	0.6	8814	
--------------	-----	------------	--	------	-----	------	--

500cc	R 50	1955 →1969		L82C	0.6	8814	
	R 50/5		OE010	N7YC	0.7	8332	PRO-5M
	R 50S	1960 →1962		L82C	0.6	8814	
	R 52	1928 →1929	OE037	L86C			

600cc	R 6	1937 →1937	OE037	L86C			
	R 60			L78C	0.6	8883	
	R 60 5, 6, 7	1969 →1978	OE010	N7YC	0.8	8332	PRO-5M
	R 67, 67/2	1951 →1954		L78C	0.6	8883	
	R 68	1952 →1954		L78C	0.6	8883	
	R 69	1955 →1960		L78C	0.6	8883	
	R 69S	1960 →1969	OE040	N2C	0.6	8904	

650cc	F 650	1994 →2000	OE083	RA6HC		8809	
	F 650 CS	2002 →2005	OE083	RA6HC		8809	
	F 650 GS	2001 →	OE083	RA6HC		8809	
	F 650 GS Dakar	2000 →	OE083	RA6HC		8809	
	F 650 ST	1997 →2001	OE083	RA6HC		8809	
	F 650 Twinspark	1994 →2000	OE083	RA6HC		8809	
	G 650 Xchallenge	2007 →	OE083	RA6HC		8809	
	G 650 Xcountry	2007 →	OE083	RA6HC		8809	
	G 650 Xmoto	2007 →	OE083	RA6HC		8809	
	R 65	1980 →1990	OE001	N9YC	0.6	8415	PRO-5M

BIMOTA

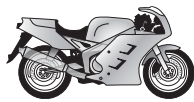
**21****POWER
SPORT**

...BMW							
...650cc	R 65 US	1978→1980	OE001	N9YC	0.6	8415	PRO-5M
	R 65, R 65 GS	1985→1996	OE001	N9YC	0.6	8415	PRO-5M
	SE Strada	2000→	OE083	RA6HC	0.9	8809	
736cc	R 16	1929→1935	OE037	L86C			
	R 17	1935→1937		D14			
745cc	R 11	1929→1934	OE037	L86C			
	R 12-2	1935→1942	OE037	L86C			
	R 71	1938→1941	OE037	L86C			
750cc	K 75	1985→1999		P-RA7HC		8812	
	K 75 RT	1990→1999		P-RA7HC		8812	
	K 75 S	1985→1999		P-RA7HC		8812	
	R 75/5, R 75/6, R 75/7	1969→1979	OE010	N7YC	0.6	8332	PRO-5M
800cc	F 800 GS	2006→	OE073	RA4HC	0.6		
	F 800 S	2006→	OE073	RA4HC	0.6		
	F 800 ST	2006→	OE073	RA4HC	0.6		
	R 80 / 7N / 7S	1977→1995	OE001	N9YC	0.6	8415	PRO-5M
	R 80 GS	1982→1994	OE001	N9YC	0.6	8415	PRO-5M
	R 80 R	1980→	OE010	N7YC	0.6	8332	PRO-5M
	R 80 RT	1982→1995	OE001	N9YC	0.6	8415	PRO-5M
	R 80 ST	1982→1990	OE001	N9YC	0.6	8415	PRO-5M
	R 80/7, R 80IN, US	1982→1989	OE001	N9YC	0.6	8415	PRO-5M
850cc	R 850 C	1999→	OE014	RC7YCC	0.9		PRO-5M
	R 850 GS	1998→2001	OE026	RC8DMC			
	R 850 R	1995→2001	OE014	RC7YCC	0.9		PRO-5M
	R 850 R	1995→2001	OE014	RC7YCC	0.9		PRO-5M
	R 850 R, Comfort	2002→	OE077	RC7BYC4	0.8		PRO-5M
	R 850 R, Comfort	2002→	OE077	RC7BYC4	0.8		PRO-5M
	R 850 RT	1999→2001	OE026	RC8DMC			
900cc	R 90 S, R 90/6	1973→1976	OE087	N6YC	0.6	8902	PRO-5M
990cc	K 100 Limited Edition	1990→1994		P-RA7HC		8812	
	K 100 LT / RT	1983→1991		P-RA7HC		8812	
	K 100 RS 16V	1989→1994		P-RA7HC		8812	
	K 100, K 100 RS	1983→1990		P-RA7HC		8812	
	K1 16V	1989→1994		P-RA7HC		8812	
	R 100 GS	1980→1995	OE010	N7YC	0.6	8332	PRO-5M
	R 100 GS Paris Dakar	1986→1995	OE010	N7YC	0.6	8332	PRO-5M
	R 100 GS PD Classic	1995→1999	OE010	N7YC	0.6	8332	PRO-5M
	R 100 R	1992→1995	OE010	N7YC	0.6	8332	PRO-5M
	R 100 R Classic	1995→2000	OE010	N7YC	0.6	8332	PRO-5M
	R 100 R Mystic	1994→2000	OE010	N7YC	0.6	8332	PRO-5M
	R 100 RT	1978→1995	OE010	N7YC	0.6	8332	PRO-5M
	R 100 RT Classic	1995→1999	OE010	N7YC	0.6	8332	PRO-5M
	R 100 S, RS	1973→1986	OE010	N7YC	0.6	8332	PRO-5M
	R 100, R 100/7	1976→1978	OE010	N7YC	0.6	8332	PRO-5M
1000cc	K1	1989→1994		P-RA7HC	0.7	8812	
	K100 LT, RT	1983→1991		P-RA7HC	0.7	8812	
	K100 RS	1983→1989		P-RA7HC	0.7	8812	
	K100 RS	1989→1994		P-RA7HC	0.7	8812	

**BMW**

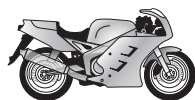
**21****POWER SPORT****...BMW**

1100cc	K 1100 16V	1992 → 1995	P-RA7HC		8812	
	K 1100 LT 16V	1992 → 1999	P-RA7HC		8812	
	K 1100 LT 16V Special Edition	1994 → 1999	P-RA7HC		8812	
	K 1100 RS 16V	1993 → 1998	P-RA7HC		8812	
	R 1100 GS	1994 → 1999	OE014 RC7YCC	0.9		PRO-5M
	R 1100 R	1995 → 2000	OE077 RC7BYC4	0.8		PRO-5M
	R 1100 RS	1993 → 2000	OE077 RC7BYC4	0.8		PRO-5M
	R 1100 RT	1995 → 2000	OE077 RC7BYC4	0.8		PRO-5M
	R 1100 S	1998 → 2003	OE026 RC8DMC			
	R 1100 S Twinspark	2003 →	OE026 RC8DMC			
R 1100 S Twinspark	2003 →	OE052 RA4HCX				
1150cc	R 1150 all models Twinspark	2003 →	OE026 RC8DMC			
	R 1150 all models Twinspark	2003 →	OE052 RA4HCX			
	R 1150 GS	2000 → 2003	OE026 RC8DMC			
	R 1150 GS Adventure	2002 → 2003	OE026 RC8DMC			
	R 1150 R Rockster	2001 → 2003	OE026 RC8DMC			
	R 1150 RS	2000 → 2003	OE026 RC8DMC			
	R 1150 RT	2002 → 2004	OE026 RC8DMC			
1200cc	HP2 Twinspark	2005 →	OE026 RC8DMC			
	HP2 Twinspark	2005 →	OE052 RA4HCX			
	K 1200	2005 →	OE083 RA6HC	0.6	8809	
	K 1200 GT	2006 →	OE083 RA6HC	0.6	8809	
	K 1200 GT	2003 → 2005	OE083 RA6HC	0.6	8809	
	K 1200 LT	2000 →	OE083 RA6HC	0.6	8809	
	K 1200 R Sport	2007 →	OE083 RA6HC	0.6	8809	
	K 1200 RS	1997 →	OE083 RA6HC	0.6	8809	
	K 1200 S	2004 →	OE083 RA6HC	0.6	8809	
	R 1200 C	1997 → 2002	OE014 RC7YCC	0.9		
	R 1200 C Avantgarde	2002 → 2004	OE077 RC7BYC4	0.8		
	R 1200 CL	2003 → 2005	OE077 RC7BYC4	0.8		
	R 1200 GS (Twinspark)	2004 → 2005	OE052 RA4HCX			
	R 1200 GS Adventure (Twinspark)	2006 →	OE052 RA4HCX			
	R 1200 R (Twinspark)	2006 →	OE052 RA4HCX			
	R 1200 S (Twinspark)	2006 →	OE052 RA4HCX			
R 1200 ST, RT (Twinspark)	2005 →	OE052 RA4HCX				

BOOM TRIKE

1600cc	Ford Engine		OE031 RES9YCC4	1.0		
	VW Engine - Carburetor		OE037 L86C	0.6		
	VW Engine - Carburetor - Increased Output		L82C	0.6	8814	
	VW Engine - Injection		OE015 N12YC	0.8	8405	
2000cc	Ford Engine		OE031 RES9YCC4	1.0		

BOSS HOSS

5700cc	All models (350hp)		RS14YC6	1.5		
6000cc	All models (364hp)		RS14YC	1.0		
8226cc	BHC 3-502 (502hp)		RN14YC			

BS VILLA

50cc	AX	1993 →	OE086 RL82C	0.5	8814	
	GZ	1993 →	OE086 RL82C	0.5	8814	

BSA

50cc	Beaver		OE037 L86C	0.5		
	Boxer		OE037 L86C	0.5		
	Brigand		OE037 L86C	0.5		
	Easy Rider ER1, ER2, Junior		OE074 N5C	0.5	8339	

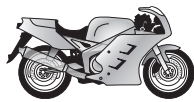
**21****POWER SPORT****...BSA**

125cc	Tracker		OE068	N3C	0.5	8904	
175cc	Bantam D10, D14, D14/4, D14/5		OE079	N4C	0.5	8339	
	Bushman		OE079	N4C	0.5	8339	
	Tracker		OE068	N3C	0.5	8904	
250cc	B25 R		OE068	N3C	0.5	8904	
	B25 Starfire		OE068	N3C	0.5	8904	
	B25 T Victor		OE068	N3C	0.5	8904	
	C11 Iron head			L82C	0.5	8814	
	SS Gold Star		OE068	N3C	0.5	8904	
350cc	B31			L82C	0.5	8814	
	B40		OE079	N4C	0.5	8339	
	B40 SS90		OE074	N5C	0.5	8339	
440cc	Victor B44ET, B44GP, B44R, B44S, B44VS		OE079	N4C	0.5	8339	
500cc	A50		OE068	N3C	0.5	8904	
	A50 C		OE079	N4C	0.5	8339	
	A50 CC		OE079	N4C	0.5	8339	
	A50 W		OE079	N4C	0.5	8339	
	A7		OE079	N4C	0.5	8339	
	B33		OE079	N4C	0.5	8339	
	B33 Gold Star			L82C	0.5	8814	
	B33 Iron head		OE068	N3C	0.5	8904	
	B34		OE079	N4C	0.5	8339	
	B34 Gold Star			L82C	0.5	8814	
	B34 Iron head		OE068	N3C	0.5	8904	
	B50 MX		OE068	N3C	0.5	8904	
	B50 SS		OE079	N4C	0.5	8339	
	B50 T Victor		OE079	N4C	0.5	8339	
	Gold Star		OE079	N4C	0.5	8339	
	M33 Iron head			L82C	0.5	8814	
Victor		OE068	N3C	0.5	8904		
600cc	M21 Iron head		OE074	N5C	0.5	8339	
650cc	A10 Golden Flash		OE068	N3C	0.5	8904	
	A10 Super Rocket		OE079	N4C	0.5	8339	
	A65 FS, L, SS		OE079	N4C	0.5	8339	
	A65 LC, R, T, H,		OE079	N4C	0.5	8339	
	Firebird		OE068	N3C	0.5	8904	
	Lightning		OE068	N3C	0.5	8904	
	Thunderbolt		OE068	N3C	0.5	8904	
	750cc	A75 Rocket 3		OE068	N3C	0.6	8904
BSM							
50cc	City	1999 → 2001	OE064	RL82YC	0.6	8814	
	Off Road	1999 → 2001	OE064	RL82YC	0.6	8814	
	Thunderbike	1999 →	OE064	RL82YC	0.6	8814	
	Winner	1999 →	OE064	RL82YC	0.6	8814	
100cc	Thunderbike 2	1999 →	OE064	RL82YC	0.6	8814	
125cc	125	1999 →	OE083	RA6HC	0.7	8809	
	Thunderbike 4	1999 →		RZ96C	0.7		

**BSM**

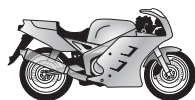
**21****POWER SPORT****BUELL**

492cc	Blast	2001 → 2005		RA8HC		8812
984cc	XB9S / SX Lightning	2008 →	OE052	RA4HCX	0.9	
	XB9S / SX Lightning	2003 → 2007	OE073	RA4HC	1.0	
	XBR9R Firebolt (V-Twin)	2001 →	OE073	RA4HC	1.0	
1000cc	RR1000	1987 → 1988	OE073	RA4HC	1.0	
1200cc	M2 Cyclone	1997 →	OE073	RA4HC	1.0	
	RR, RS, RSS	1989 → 1994		RA8HC	1.0	8812
	S1 Lightning	1996 → 1998	OE073	RA4HC	1.0	
	S1 White Lightning	1998 →	OE073	RA4HC	1.0	
	Thunderbolt S2, S2T	1995 → 1996		RA8HC	1.0	8812
	Thunderbolt S3, S3T	1997 →	OE073	RA4HC	1.0	
	Ulysses XB12X	2005 →	OE073	RA4HC	1.0	
	X1 Lightning	1999 → 2003	OE073	RA4HC	1.0	
	XB12R	2008 →	OE052	RA4HCX	0.9	
	XB12R	2006 → 2007	OE073	RA4HC	1.0	
	XB12S / SCG / SS / X / STT	2008 →	OE052	RA4HCX	0.9	
	XB12S / SCG / SS / X / STT	2004 → 2007	OE073	RA4HC	1.0	

BULTACO

50cc	49/GT		OE037	L86C	0.5	
	Astro	1998 →	OE040	N2C	0.5	8904
	Chispa		OE037	L86C	0.5	
	Lobito	1998 →	OE040	N2C	0.5	8904
	Tiron		OE037	L86C	0.5	
75cc	Brinco			L82C	0.5	8814
	Frontera			L78C	0.5	8883
	Junior GT2			L82C	0.5	8814
	Lobito		OE037	L86C	0.5	
	Sherpa T		OE037	L86C	0.5	
	Streaker		OE037	L86C	0.5	
100cc	Junior		OE037	L86C	0.5	
	Lobito		OE037	L86C	0.5	
	Lobito K			L77JC4	1.0	8883
	Sherpa S			L77JC4	1.0	8883
	Tiron		OE037	L86C	0.5	
125cc	Alpina		OE001	N9YC	0.6	8415
	Frontera		OE037	L86C	0.5	
	Junior		OE037	L86C	0.5	
	Lobito MK3/MK6		OE001	N9YC	0.6	8415
	Lobito MK7		OE037	L86C	0.5	
	Mercurio		OE037	L86C	0.5	
	Pursang MK5		OE040	N2C	0.5	8904
	Pursang MK6		OE040	N2C	0.5	8904
	Sherco	2000 →	OE004	RN9YCC	0.6	8415
	Sherpa S		OE040	N2C	0.5	8904
	Sherpa T		OE037	L86C	0.5	
	Streaker		OE037	L86C	0.5	
	Tralla		OE037	L86C	0.5	
150cc	Campera		OE037	L86C	0.5	
	Mercurio/GT/150		OE037	L86C	0.5	
	Tralla		OE037	L86C	0.5	

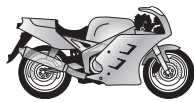
**21****POWER
SPORT****...BULTACO**

Capacity	Model	Year	OE Part	Part No.	mm	Part No.	
175cc	Alpina		OE001	N9YC	0.6	8415	
	Campera MK2		OE098	RN4C	0.5	8339	
	Lobito MK6		OE001	N9YC	0.6	8415	
	Lobito MK7		OE098	RN4C	0.5	8339	
	Mercurio		OE037	L86C	0.5		
	Mercurio GT		OE001	N9YC	0.6	8415	
	Pursang MK5		OE040	N2C	0.5	8904	
	Sherpa MK3		OE040	N2C	0.5	8904	
200cc	El Tigre		OE068	N3C	0.5	8904	
	Mercurio		OE068	N3C	0.5	8904	
	Metise		OE068	N3C	0.5	8904	
	Pursang MK5		OE040	N2C	0.5	8904	
	Senior		OE068	N3C	0.5	8904	
	Sherco	2000 →	OE004	RN9YCC	0.6	8415	
	Sherpa MK3		OE040	N2C	0.5	8904	
	Sherpa S		OE079	N4C	0.5	8339	
250cc	Alpina		OE001	N9YC	0.6	8415	
	Astro		OE040	N2C	0.5	8904	
	Frontera		OE068	N3C	0.5	8904	
	Matador 250/SD		OE001	N9YC	0.6	8415	
	Matador MK2/MK3		OE068	N3C	0.5	8904	
	Matador MK4		OE001	N9YC	0.6	8415	
	Metralla GT/MK2/MK250		OE068	N3C	0.5	8904	
	Metralla GTS		OE001	N9YC	0.6	8415	
	Pursang MK4/MK5 lado admis		OE068	N3C	0.5	8904	
	Pursang MK4/MK5 lado escap		OE040	N2C	0.5	8904	
	Pursang MK6/MK7 lado admis		OE068	N3C	0.5	8904	
	Pursang MK6/MK7 lado escap		OE040	N2C	0.5	8904	
	Sherco	1999 →	OE004	RN9YCC	0.6	8415	
	Sherpa S		OE040	N2C	0.5	8904	
Sherpa T		OE001	N9YC	0.6	8415		
290cc	Sherco	2000 →	OE004	RN9YCC	0.6	8415	
350cc	Alpina		OE001	N9YC	0.6	8415	
	Matador MK9/MK10		OE001	N9YC	0.6	8415	
	Pursang MK5/MK6 lado admis		OE068	N3C	0.5	8904	
	Pursang MK5/MK6 lado escap		OE040	N2C	0.5	8904	
	Sherpa T		OE001	N9YC	0.6	8415	
360cc	Astro lado admision		OE068	N3C	0.5	8904	
	Astro lado escape		OE040	N2C	0.5	8904	
	El Bandito MK2 lado admis.		OE068	N3C	0.5	8904	
	El Bandito MK2 lado escape		OE040	N2C	0.5	8904	
	Frontera		OE068	N3C	0.5	8904	
	Pursang lado admision		OE068	N3C	0.5	8904	
	Pursang lado escape		OE040	N2C	0.5	8904	
370cc	Frontera MK11		OE068	N3C	0.5	8904	
	Pursang lado admision		OE068	N3C	0.5	8904	
	Pursang lado escape		OE040	N2C	0.5	8904	
450cc	Pursang MK15		OE068	N3C	0.5	8904	

**BULTACO**

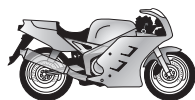
**21****POWER SPORT****...BULTACO**

175cc	SS		OE108	RN3C	0.5	8904	PRO-5M
	SX		OE108	RN3C	0.5	8904	PRO-5M
200cc	Elefant		OE091	RN2C	0.5	8904	PRO-5M
	WSXT		OE091	RN2C	0.5	8904	PRO-5M
250cc	MX		OE091	RN2C	0.5	8904	PRO-5M
	MXR		OE091	RN2C	0.5	8904	PRO-5M
	RL		OE108	RN3C	0.5	8904	PRO-5M
	RR		OE091	RN2C	0.5	8904	PRO-5M
	RX		OE091	RN2C	0.5	8904	PRO-5M
	SS		OE108	RN3C	0.5	8904	PRO-5M
	SST Ala Verde		OE108	RN3C	0.5	8904	PRO-5M
	SST N		OE108	RN3C	0.5	8904	PRO-5M
	SST NC		OE108	RN3C	0.5	8904	PRO-5M
	SST RL		OE108	RN3C	0.5	8904	PRO-5M
	SX		OE108	RN3C	0.5	8904	PRO-5M
	SXT Ala Blu		OE108	RN3C	0.5	8904	PRO-5M
	WMX 88			QN84	0.5		PRO-5M
	350cc	Ala Azzurra		OE108	RN3C	0.5	8904
Ala Blu			OE108	RN3C	0.5	8904	PRO-5M
Ala Rossa			OE108	RN3C	0.5	8904	PRO-5M
Ala Verde			OE086	RL82C	0.6	8814	PRO-5M
Elefant (Ducati mot.)			OE086	RL82C	0.6	8814	PRO-5M
Lucky			OE083	RA6HC	0.9	8809	
SST			OE108	RN3C	0.5	8904	PRO-5M
SX			OE108	RN3C	0.5	8904	PRO-5M
T4 E, R			OE083	RA6HC	0.9	8809	PRO-5M
Trial DG350, Cresta			OE045	RN11YCC	0.8	8405	
W12		1994→1996	OE073	RA4HC	0.6		SRO-5U
500cc		Canyon		OE040	N2C	0.7	8904
	MXR			QN84	0.5		
	River 'cat'		OE132	A6HC	0.8	8809	
	T4 E, R		OE083	RA6HC	0.9	8809	
	T4 Pharaon		OE083	RA6HC	0.9	8809	
600cc	Ala Azzurra (Ducati mot.)		OE064	RL82YC	0.8	8814	
	Canyon	1996→1999	OE075	C6YCC	0.8		
	River	1995→1999	OE075	C6YCC	0.7		
	Supercity	1995→	OE075	C6YCC	0.7		
	W16	1994→1995	OE075	C6YCC	0.8		
650cc	Ala Azzurra (Ducati mot.)		OE064	RL82YC	0.8	8814	
	Elefant		OE064	RL82YC	0.8	8814	
	Raptor	2001→		RG94C		8698	
	V Raptor	2001→		RG94C		8698	
750cc	Elefant Lucky, 'cat'		OE064	RL82YC	0.8	8814	
900cc	Elefant 'cat'		OE083	RA6HC	0.6	8809	
	Elefant GT		OE073	RA4HC	0.6		
	Elefant i.e.		OE073	RA4HC	0.6		
904cc	Gran Canyon 900		OE083	RA6HC	0.7	8809	
1000cc	Navigator Fi (Liquid cooled)	2000→	OE092	RG4HC		8698	
	Raptor Fi (Liquid cooled)	2000→	OE092	RG4HC		8698	
	V-Raptor Fi (Liquid cooled)	2000→	OE092	RG4HC		8698	
	Xtra-Raptor (Liquid cooled)	2003→	OE092	RG4HC		8698	

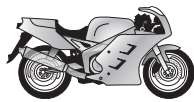
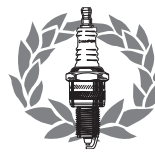
**21****POWER
SPORT****CAGIVA**

49cc	Velocifero		OE064	RL82YC	0.5	8814	
50cc	Cocis		OE108	RN3C	0.5	8904	
	K3		OE108	RN3C	0.5	8904	
	Lucky Explorer Explorer		OE091	RN2C	0.5	8904	
	Mito	1998 →		L78C	0.5	8883	
	Prima		OE108	RN3C	0.5	8904	
	Supercity		OE108	RN3C	0.5	8904	
	W4		OE108	RN3C	0.5	8904	
	W8			QN84	0.6		
75cc	Prima 80 (Liquid cooled)	1992 →	OE108	RN3C	0.5	8904	
	Supercity 80 (Liquid cooled)	1992 →	OE108	RN3C	0.5	8904	
	W4 80 (Liquid cooled)	1992 →	OE108	RN3C	0.5	8904	
106cc	Passing			RL87YC	0.8		
125cc	A8		OE040	N2C		8904	
	Alletta Electra			QN84	0.5		PRO-5M
	Alletta Official	1995 →	OE091	RN2C	0.5	8904	PRO-5M
	Alletta Oro 125S2		OE108	RN3C	0.5	8904	PRO-5M
	Alletta Rossa		OE091	RN2C	0.5	8904	PRO-5M
	Blues		OE091	RN2C	0.5	8904	PRO-5M
	Cruiser		OE091	RN2C	0.5	8904	PRO-5M
	Dakar			QN84	0.5		PRO-5M
	Elefant		OE091	RN2C	0.5	8904	PRO-5M
	Freccia C9			QN84	0.5		PRO-5M
	Freccia CR10		OE091	RN2C	0.5	8904	PRO-5M
	Freccia Sport		OE091	RN2C	0.5	8904	PRO-5M
	Freccia Sport Prod.		OE091	RN2C	0.5	8904	PRO-5M
	K7			QN84	0.5		PRO-5M
	Mito			QN84	0.5		PRO-5M
	Mito EV		OE091	RN2C	0.5	8904	PRO-5M
	Mito Evolution			QN84	0.5		PRO-5M
	Mito Lawson			QN84	0.5		PRO-5M
	Mito Sport Prod.			QN84	0.5		PRO-5M
	N90		OE091	RN2C	0.5	8904	PRO-5M
	Planet	1997 →		QN84	0.5		PRO-5M
	Raptor	2000 →	OE091	RN2C	0.5	8904	PRO-5M
	RL		OE108	RN3C	0.5	8904	PRO-5M
	Roadster		OE091	RN2C	0.5	8904	PRO-5M
	RX			QN84	0.5		PRO-5M
	SS		OE108	RN3C	0.5	8904	PRO-5M
	SST Low Rider		OE108	RN3C	0.5	8904	PRO-5M
	ST	1995 →	OE091	RN2C	0.5	8904	PRO-5M
	Supercity			QN84	0.5		PRO-5M
	SX		OE108	RN3C	0.5	8904	PRO-5M
	SXT	1995 →	OE091	RN2C	0.5	8904	PRO-5M
	Tamanaco		OE091	RN2C	0.5	8904	PRO-5M
	Trial		OE091	RN2C	0.5	8904	PRO-5M
	W8	1995 →	OE091	RN2C	0.5	8904	PRO-5M
	WMX 84			QN84	0.5		PRO-5M
	WMX 85			QN84	0.5		PRO-5M
WMX 88			QN84	0.5		PRO-5M	
WR / WRE	2002 →		QN84	0.5			
WRX			QN84	0.5		PRO-5M	
WSXT			QN84	0.5		PRO-5M	

**CAGIVA**

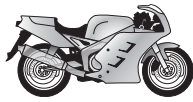
**21****POWER SPORT****CAN-AM**

125cc	Family		OE091	RN2C	0.5	8904
	MX1		OE091	RN2C	0.5	8904
	MX6		OE091	RN2C	0.5	8904
	Qualifier		OE091	RN2C	0.5	8904
175cc	MX1		OE091	RN2C	0.5	8904
	Qualifier		OE091	RN2C	0.5	8904
	TNT		OE091	RN2C	0.5	8904
250cc	GP		OE091	RN2C	0.5	8904
	Military		OE091	RN2C	0.5	8904
	MX III		OE091	RN2C	0.5	8904
	MX4		OE091	RN2C	0.5	8904
	MX6		OE091	RN2C	0.5	8904
	Qualifier		OE091	RN2C	0.5	8904
	TNT		OE091	RN2C	0.5	8904
275cc	Qualifier 350		OE091	RN2C	0.5	8904
370cc	370		OE091	RN2C	0.5	8904
400cc	MX6		OE091	RN2C	0.5	8904
	Qualifier		OE091	RN2C	0.5	8904
998cc	Spyder Roadster		OE073	RA4HC	0.7	

CANNONDALE

432cc	EX 400	2001 →	OE092	RG4HC	0.7	8698
	MX 400	2000 →	OE092	RG4HC	0.7	8698
	XC 400	2001 →	OE092	RG4HC	0.7	8698

CAPRI

50cc	All models		OE037	L86C	0.5	
70cc	All models		OE037	L86C	0.5	
80cc	All models		OE037	L86C	0.5	
98cc	All models		OE037	L86C	0.5	
125cc	All models		OE037	L86C	0.5	
150cc	All models		OE037	L86C	0.5	

CARABELA

50cc	Carrera		OE059	L92YC	0.5	
	Super SP / de Luxe		OE059	L92YC	0.5	
60cc	Ciclo Motor Ciao		OE037	L86C	0.5	
	Merida, Mototic, Motopony		OE037	L86C	0.5	
100cc	Coyote Enduro		OE074	N5C	0.5	8339
	Coyote MX		OE079	N4C	0.6	8339
	Enduro , MX		OE037	L86C	0.5	
	Marquesa MX		OE068	N3C	0.5	8904
	Marquesa Enduro		OE079	N4C	0.6	8339
	Marquesa Mini Enduro		OE074	N5C	0.5	8339
	Marquesa Mini MX		OE079	N4C	0.6	8339
	Mini Moto		OE074	N5C	0.5	8339
	Motorcarro 100		OE074	N5C	0.5	8339
	Panthera		OE037	L86C	0.5	
	Panthera100,Sprint 100, TS-3 100		OE074	N5C	0.5	8339
	Rally Enduro		OE074	N5C	0.5	8339
	Torero Flat Track		OE068	N3C	0.5	8904

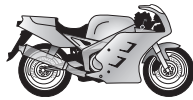
**21****POWER SPORT****...CARABELA**

125cc	Caliente		OE074	N5C	0.5	8339	
	Coyote Enduro		OE074	N5C	0.5	8339	
	Coyote MX		OE079	N4C	0.6	8339	
	De Luxe		OE074	N5C	0.5	8339	
	Marquesa MX 111		OE068	N3C	0.5	8904	
	Marquesa MXV		OE068	N3C	0.5	8904	
	Mini Enduro		OE074	N5C	0.5	8339	
	Rally Enduro		OE074	N5C	0.5	8339	
	Torero Flat Track		OE068	N3C	0.5	8904	
175cc	Marquesa Enduro		OE068	N3C	0.5	8904	
	Marquesa MK-II		OE068	N3C	0.5	8904	
	Rally Enduro		OE074	N5C	0.5	8339	
	Strada		OE074	N5C	0.5	8339	
	Torero Flat Track		OE068	N3C	0.5	8904	
200cc	Enduro		OE074	N5C	0.5	8339	
	Moto Cross		OE068	N3C	0.5	8904	
	Motocarro Ariete		OE074	N5C	0.5	8339	
	Super Turismo		OE074	N5C	0.5	8339	
250cc	Centaurio Enduro		OE068	N3C	0.5	8904	
	Centaurio MX-II, MX-III, MX-IV		OE068	N3C	0.5	8904	
	Torero Flat Track		OE068	N3C	0.5	8904	
360cc	Centaurio MX-III		OE068	N3C	0.5	8904	
400cc	Enduro		OE074	N5C	0.5	8339	
	MX		OE068	N3C	0.5	8904	
450cc	Centaurio MX-II		OE068	N3C	0.5	8904	
	Enduro		OE074	N5C	0.5	8339	
	Torero Flat Track		OE079	N4C	0.6	8339	

CARREFOUR

50cc	Web / Gap	2000 →		L82C	0.5	8814	
125cc	PFM	2000 →	OE083	RA6HC	0.7	8809	

CASAL

50cc	Carina		OE086	RL82C	0.5	8814	
	Cross			L77JC4	1.0	8883	
	K164		OE086	RL82C	0.5	8814	
	K165		OE086	RL82C	0.5	8814	
	K166		OE086	RL82C	0.5	8814	
	K166 , Boss,-C,-F		OE086	RL82C	0.5	8814	
	K167		OE086	RL82C	0.5	8814	
	K168		OE086	RL82C	0.5	8814	
	K177 , Futur Matic		OE086	RL82C	0.5	8814	
	K180		OE086	RL82C	0.5	8814	
	K181			L77JC4	1.0	8883	
	K181 S		OE086	RL82C	0.5	8814	
	K182 S			L77JC4	1.0	8883	
	K184			L77JC4	1.0	8883	
	K184 S		OE086	RL82C	0.5	8814	
	K185			L77JC4	1.0	8883	
	K187 , SS		OE086	RL82C	0.5	8814	
	K188 (Enduro)			L77JC4	1.0	8883	
	K190 GB, NL		OE086	RL82C	0.5	8814	
	K191			L77JC4	1.0	8883	
	K191 A			L77JC4	1.0	8883	
	K191 G		OE086	RL82C	0.5	8814	
	K192		OE086	RL82C	0.5	8814	

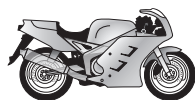

**21****POWER SPORT****...CASAL****...50cc**

K196		OE086	RL82C	0.5	8814
K197		OE086	RL82C	0.5	8814
K551, D		OE037	L86C	0.5	
KS84 SS		OE086	RL82C	0.5	8814
M105		OE086	RL82C	0.5	8814
M106 Cross		OE091	RN2C	0.5	8904
M109			L78C	0.5	8883
M112		OE086	RL82C	0.5	8814
M1157		OE037	L86C	0.5	
M118 Cross		OE091	RN2C	0.5	8904
M140			L82C	0.5	8814
M147			L82C	0.5	8814
M148		OE037	L86C	0.5	
M149		OE037	L86C	0.5	
M233		OE068	N3C	0.5	8904
M251		OE086	RL82C	0.5	8814
M252		OE086	RL82C	0.5	8814
M253		OE086	RL82C	0.5	8814
M254			L78C	0.5	8883
RZ D LC		OE086	RL82C	0.5	8814
RZ554 K		OE086	RL82C	0.5	8814
Super Boss K 168-8			L78C	0.5	8883
Super Boss RE			L77JC4	0.5	8883

125cc

M233 Cross

OE091 RN2C 0.5 **8904****CAZENAVE VAP PALOMA****50cc**

610		OE037	L86C	0.5	
671		OE037	L86C	0.5	
672		OE037	L86C	0.5	
673		OE037	L86C	0.5	
674		OE037	L86C	0.5	
675		OE037	L86C	0.5	
DK		OE037	L86C	0.5	
La Baulle		OE037	L86C	0.5	
Pat		OE037	L86C	0.5	
Peggy, Super		OE037	L86C	0.5	
Velovap		OE037	L86C	0.5	

200cc

Ultima

OE037 L86C 0.5**CCM****125cc**

CMX		OE040	N2C	0.5	8904
MX (Hiro mot.)			QN84	0.5	

240cc

CMT Trials

OE015 N12YC 0.7 **8405****250cc**

CMT Trials		OE015	N12YC	0.7	8405
CMX		OE068	N3C	0.5	8904
CMX I/C		OE040	N2C	0.5	8904
MX		OE108	RN3C	0.5	8904
MX (Hiro mot.)			QN84	0.5	

310cc

CMT Trials

OE015 N12YC 0.7 **8405****320cc**

CMT Trials

OE015 N12YC 0.7 **8405****350cc**

CM 36 Road Racer	1978 →	OE040	N2C	0.5	8904
CMT Trials		OE015	N12YC	0.7	8405
Trials	1978 →	OE074	N5C	0.5	8339

450cc

CMX

1982 → **OE068** N3C 0.5 **8904****490cc**

CMX

OE040 N2C 0.5 **8904**

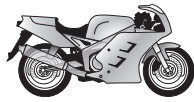
**21****POWER SPORT****...CCM**

500cc	4V models		G55C	0.5	8654
	B5		OE037 L86C	0.5	
	CMX		OE083 RA6HC	0.7	8809
	Enduro 8:1 c.r.		OE098 RN4C	0.5	8339
	M149		OE037 L86C	0.5	
	MTT		OE083 RA6HC	0.7	8809
	MX 2V		OE037 L86C	0.5	
	MX 2V		OE037 L86C	0.5	
	MX 4V		G63		
550cc	B6		OE037 L86C	0.5	
560cc	2 stroke		OE083 RA6HC	0.7	8809
	4 stroke		OE083 RA6HC	0.7	8809
580cc	M148		OE037 L86C	0.5	
600cc	604 R / RS / R30		OE083 RA6HC	0.7	8809
	604 Roadster RS	2001→	OE083 RA6HC	0.7	8809
	604 Supermoto dual sport	2001→	OE083 RA6HC	0.7	8809
	604 Trail dual sport	2001→	OE083 RA6HC	0.7	8809
636cc	604E Sport, Supermoto, R	2000→	OE083 RA6HC	0.8	8809
650cc	644	2002→	OE092 RG4HC	0.7	8698
	R30 Supermotard	2002→	OE092 RG4HC	0.7	8698

CECCATO

49cc	All models		OE037 L86C	0.5	
75cc	All models		OE108 RN3C	0.5	8904
100cc	S		OE108 RN3C	0.5	8904
	T		OE086 RL82C	0.5	8814
125cc	S		OE108 RN3C	0.5	8904
	T		OE108 RN3C	0.5	8904
175cc	S		OE108 RN3C	0.5	8904
	T		OE037 L86C	0.5	

CHIBI

	Mini-Bikes		J4C	0.8	
--	------------	--	-----	-----	--

CHIORDA

50cc	Moped		OE037 L86C	0.5	
-------------	-------	--	-------------------	-----	--

CHUNLAN

50cc	CL50 QT-5 Scooter (2 Stroke)	1999→	OE064 RL82YC		8814
125cc	CL125 3-A	1999→	Z9Y		

CIMATTI

50cc	Baby		OE037 L86C	0.5	
	Basket		OE037 L86C	0.5	
	Bat		OE037 L86C	0.5	
	Boy		OE037 L86C	0.5	
	C		OE037 L86C	0.5	
	Chic		OE037 L86C	0.5	
	City Bike		OE037 L86C	0.5	
	Clan		OE037 L86C	0.5	
	Kaiman		OE098 RN4C	0.5	8339
	Piper		OE037 L86C	0.5	
	Piper 4M		OE086 RL82C	0.5	8814
	S		OE037 L86C	0.5	
100cc	C		OE037 L86C	0.5	
	ST		OE037 L86C	0.5	
	XR		OE108 RN3C	0.5	8904

**CIMATTI**

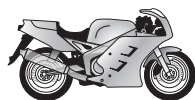
**21****POWER SPORT****...CIMATTI**

150cc	Ariete		OE108	RN3C	0.5	8904	
	C		OE037	L86C	0.5		
160cc	C		OE108	RN3C	0.5	8904	
	ST		OE108	RN3C	0.5	8904	

CLAEYS FLANDRIA (→ Flandria)

cc							
----	--	--	--	--	--	--	--

CLIPIC

50cc	Trial	2000→		L82C	0.5	8814	
	Trial E	2000→		C57	0.5		
80cc	Trial R	2000→	OE040	N2C	0.5	8904	

COSMO

	Mini-Cross Mini Bike		OE006	RN9YC	0.8	8415	
--	----------------------	--	--------------	-------	-----	-------------	--

COSSACK

125cc	Minsk		OE086	RL82C	0.5	8814	
175cc	Voskhod		OE086	RL82C	0.5	8814	
350cc	Jupiter		OE086	RL82C	0.5	8814	
	Jupiter horizontal CH30 Garelli		OE037	L86C	0.5		
	Planeta		OE086	RL82C	0.5	8814	
650cc	Dnepr		OE086	RL82C	0.5	8814	
	M63		OE037	L86C	0.5		
	M66		OE037	L86C	0.5		
	Ural , MT10		OE037	L86C	0.5		
	Jupiter MA 502, 503 (Sachs mot.)		OE037	L86C	0.5		
	Mars		OE037	L86C	0.5		

COTTON (→ Villiers)**CPI**

50cc	Supercross	2003→	OE098	RN4C	0.8	8339	
	Supermoto	2003→	OE098	RN4C	0.8	8339	
	Supermoto SMX	2006→	OE108	RN3C	0.8	8904	

CR & S

650cc	Vun	2007→	OE083	RA6HC	0.6	8809	
-------	-----	-------	--------------	-------	-----	-------------	--

CRAZY VEHICLE

125cc	Crazy Buggy	2003→		RZ96C	0.6		
-------	-------------	-------	--	-------	-----	--	--

CYRUS

50cc	Royal Super			L78C	0.5	8883	
73cc	Royal S5			L78C	0.5	8883	
	Royal Trial 80			L78C	0.5	8883	

CZ (→ Jawa/ CZ)**DAELIM**

125cc	VEE	1999→		RGU94C		8698	
	VJ	2003→2004		RGU94C		8698	
	VL	2003→2004		RGU94C		8698	
	VT Evolution	1998→		RGU94C		8698	

DALESMAN

125cc	Enduro (Sachs mot.)		OE086	RL82C	0.5	8814	
	Trail MX (Puch mot.)		OE108	RN3C	0.5	8904	

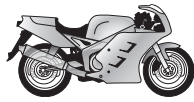
**21****POWER
SPORT****DEMM**

49cc	Brio		OE037	L86C	0.5		
	Condor 4		OE037	L86C	0.5		
	Joy		OE037	L86C	0.5		
	Panther		OE037	L86C	0.5		
	Quick		OE037	L86C	0.5		
	RG6		OE037	L86C	0.5		
125cc	GT		OE037	L86C	0.5		
	N		OE037	L86C	0.5		
	T		OE037	L86C	0.5		

DERBI

49cc	Antorcha Campeona, Olimpica		OE037	L86C	0.5		
	Coppa FT, FDT		OE086	RL82C	0.5	8814	
	Coppa Turismo, Sport		OE086	RL82C	0.5	8814	
	Cross		OE037	L86C	0.5		
	Diablo Cross		OE037	L86C	0.5		
	Diablo Super C4		OE037	L86C	0.5		
	Diablo Super C-5, C-7		OE086	RL82C	0.5	8814	
	DS 50		OE086	RL82C	0.5	8814	
	Especial		OE037	L86C	0.5		
	GT		OE037	L86C	0.5		
	GTS		OE037	L86C	0.5		
	Montreal		OE037	L86C	0.5		
	Scout		OE086	RL82C	0.5	8814	
	Tricampeona		OE037	L86C	0.5		
	Variant		OE086	RL82C	0.5	8814	
	Yumbo CX, FD, FDS, RD2		OE086	RL82C	0.5	8814	
50cc	Aceno	1998 →		L78C	0.5	8883	
	Box			QL78C	0.5	8883	
	Campera			L78C	0.5	8883	
	Dirt Boy	2003 →	OE092	RG4HC	0.7	8698	
	Dirt Kid	2003 →	OE092	RG4HC	0.7	8698	
	Easy		OE086	RL82C	0.5	8814	
	FDS / GTS / RD-2	→1991		L82C	0.5	8814	
	Fenix	1993 →		QL78C	0.5	8883	
	MXR	1996 →		L78C	0.5	8883	
	Naked	2004 →	OE068	N3C	0.6	8904	
	Olimpica		OE037	L86C	0.6		
	R DRD / Racer / X-treme		OE068	N3C		8904	
	RD-2 Country	1992 →		L78C	0.5	8883	
	Savanah		OE037	L86C	0.5		
	Senda (Air cooled)			L78C	0.5	8883	
	Senda (Liquid cooled)		OE040	N2C	0.5	8904	
	Senda		OE068	N3C	0.5	8904	
	Senda , R	1992 →	OE091	RN2C	0.5	8904	
	SM Black Edition	2002 →	OE068	N3C		8904	
	SM DRD / Racer / X-treme	2002 →	OE040	N2C		8904	
	Sport			QL78C	0.5	8883	
	Start		OE037	L86C	0.5		
	Supermotard Dual sport concept Liquid cooled	1995 →	OE040	N2C		8904	
	Urban	1995 →		QL78C	0.5	8883	
	X Race / Race R / X-Treme	2002 →	OE040	N2C		8904	
	Yumbo	→1991		QL78C	0.5	8883	

**DERBI**

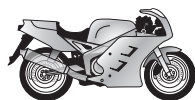
**21****POWER SPORT****...DERBI**

75cc	C6		OE091	RN2C	0.6	8904
	C8		OE091	RN2C	0.6	8904
	Coppa 74 Sport		OE091	RN2C	0.5	8904
	Coppa Sport		OE091	RN2C	0.5	8904
	CR81			QN84	0.5	
	CR82 Cross			QN84	0.5	
	Derbi 74		OE086	RL82C	0.5	8814
	Europa		OE091	RN2C	0.5	8904
	GPR			QN84	0.6	
	Gran Prix 74		OE037	L86C	0.5	
	Gran Sport		OE086	RL82C	0.5	8814
	Scoot		OE108	RN3C	0.5	8904
	Sport 1001, 74		OE091	RN2C	0.5	8904
	TT8		OE091	RN2C	0.5	8904
Vivo		OE059	L92YC	0.6		
80cc	BI 3	1995 →	OE068	N3C	0.5	8904
125cc	Coppa Sport			QN84	0.5	
	CR82 Cross Agua			QN84	0.5	
	Cross 1983			QN84	0.5	
	CRS / RC		OE040	N2C	0.5	8904
	CRS81 Cross			QN84	0.5	
	Enduro / RS125TT / Karmathan		OE040	N2C	0.5	8904
	Nude GPR	2004 →	OE091	RN2C	0.5	8904
	Racing GPR	2004 →	OE091	RN2C	0.5	8904
	Senda R / SM	2002 →	OE073	RA4HC	0.6	
TTS9		OE091	RN2C	0.5	8904	
200cc	2002		OE091	RN2C	0.6	8904
	2002 AA		OE091	RN2C	0.6	8904
	2002 Grand Prix		OE091	RN2C	0.6	8904
250cc	CRX Cross			QN84	0.5	
	Enduro			QN84	0.5	
	RC			QN84	0.5	
	Turismo		OE091	RN2C	0.5	8904
660cc	Mulhacén 659	2005 →		RG96C	0.6	8698

DI BLASI

Express Folding Motorbike

RL86C

0.8

DKW

48cc	Hummel Super Typ 116 2,0PS	1959 → 1963		L82C	0.5	8814	
	Hummel Super Typ 126 2,0PS	1960 → 1963		L82C	0.5	8814	
	Hummel Super Typ 156 3,1+4,2PS	1960 → 1963		L78C	0.6	8883	
	Hummel Typ 115 2,0PS	1960 → 1963		L82C	0.5	8814	
	Hummel Standard 1 Typ 113 2,0PS	1959 → 1963		L82C	0.5	8814	
	Hummel Standard 2 Typ 113 2,0PS	1959 → 1963		L82C	0.5	8814	
	Kavalier Typ 115 2,0PS	1962 → 1963		L82C	0.5	8814	
	Kavalier Typ 155 3,1+4,2PS	1962 → 1963		L78C	0.6	8883	
	Violetta Typ 128 2,0PS	1960 → 1963		L82C	0.5	8814	
	Violetta Sport Typ 158 3,1+4,2PS	1960 → 1963		L78C	0.6	8883	
	50cc	139 M F&S 501/4 BKF	1972 → 1976		L82C	0.5	8814
		159 ES F&S 50 SA	1972 → 1976	OE037	L86C	0.5	
		504 M F&S 504/1B	1972 → 1976	OE037	L86C	0.5	
505 P F&S 504/1A		1972 → 1976	OE037	L86C	0.5		
506 M F&S 504/1B		1972 → 1976	OE037	L86C	0.5		
510 F&S 504/1B		1972 → 1976	OE037	L86C	0.5		
530 F&S 504/1B		1976 → 1983	OE037	L86C	0.5		

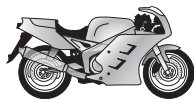
**21****POWER
SPORT****...DKW****...50cc**

532	F&S 505/1B	1976→1983	OE037	L86C	0.5	
533	F&S 505/2B	1976→1983	OE037	L86C	0.5	
534	F&S 505/1B	1976→1983	OE037	L86C	0.5	
535	F&S 505/2B	1976→1983	OE037	L86C	0.5	
630	F&S 50/2MB	1972→1976		L82C	0.5	8814
632	F&S 50/2MB	1972→1976		L82C	0.5	8814
Aero 136	2,6PS	1964→1965		L82C	0.5	8814
Aero 166	5,3PS	1964→1965		L78C	0.6	8883
Hummel Super Typ 136	2,6PS	1964→1965		L82C	0.5	8814
Hummel Typ 115	2,6PS	1964→1965		L82C	0.5	8814
Hummel Typ 155	4,2PS	1964→1965		L78C	0.6	8883
Hummel Typ 166	5,3PS	1964→1965		L78C	0.6	8883
Hummel Standard 1 Typ 113	2,0PS	1964→1965		L82C	0.5	8814
Hummel Standard 2 Typ 113	2,0PS	1964→1965		L82C	0.5	8814
Jet	F&S 50s	1972→1976	OE037	L86C	0.5	
Sportmofa	F&S 505/2B	1980→1983	OE037	L86C	0.5	
Violetta MK 128	2,0PS	1964→1965		L82C	0.5	8814

125cc

125 E	F&S 1251/6C	1972→1976		L78C	0.6	8883
-------	-------------	-----------	--	------	-----	------

175cc

RT 175		1959→		L82C	0.5	8814
RT 250		1959→		L82C	0.5	8814

200cc

RT 200 H		1952→	OE037	L86C	0.5	
----------	--	-------	--------------	------	-----	--

DNEPR**649cc**

Dnepr -300		1997→	OE059	L92YC	0.6	
------------	--	-------	--------------	-------	-----	--

650cc

11 J Gespann	28Kw		OE038	L82YC	0.6	8814
16 J Gespann	28Kw		OE038	L82YC	0.6	8814
KM3-8.157			OE001	N9YC	0.7	8415
KM3-8.157-022			OE001	N9YC	0.7	8415
MT 11	20KW		OE038	L82YC	0.6	8814
MT 16	20KW		OE038	L82YC	0.6	8814

DOT**50cc**

Dot mot.			OE086	RL82C	0.5	8814
Minarelli mot.			OE086	RL82C	0.5	8814
Villiers mot. Other models			OE086	RL82C	0.5	8814
Vivi Monza			OE037	L86C	0.5	

175cc

Guazzoni				RN5C	0.5	8339
Scramblers				C55R	0.5	
Trials			OE086	RL82C	0.5	8814

197cc

Scramblers				QL55	0.4	
Villiers			OE086	RL82C	0.5	8814

246cc

Villiers			OE086	RL82C	0.5	8814
----------	--	--	--------------	-------	-----	------

DUCATI**100cc**

Sport		1958→1960		L82C	0.6	8814
-------	--	-----------	--	------	-----	------

125cc

Regolarità				QL55	0.6	
Scrambler			OE037	L86C	0.6	
Six Days				QL55	0.6	
Sport		1958→1965		L82C	0.6	8814
TS		1959→1965	OE037	L86C	0.6	

160cc

Monza			OE037	L86C	0.6	
S			OE037	L86C	0.6	
TS			OE037	L86C	0.6	

175cc

Sport		1958→1961		L82C	0.6	8814
TS		1958→1960	OE037	L86C	0.6	

**DUCATI**

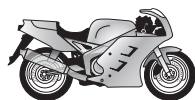
**21****POWER
SPORT****...DUCATI**

200cc	Elite	1959 → 1965	OE037	L86C	0.6	
	TS		OE037	L86C	0.6	
250cc	24 Hrs			L82C	0.6	8814
	Daytona			L78C	0.6	8883
	Desmo			L82C	0.6	8814
	Mack I	1964 → 1966	OE037	L86C	0.6	
	Mk III			QL55	0.6	
	Monza	1968 →	OE037	L86C	0.6	
	SCR	1968 → 1974	OE037	L86C	0.6	
	SCR-MC	1962 → 1967	OE037	L86C	0.6	
	Strada		OE037	L86C	0.6	
350cc	Desmo , Sport		OE037	L86C	0.6	
	F3	1986 → 1987	OE037	L86C	0.6	
	F3 Desmo		OE007	L87YC	0.6	
	Forza		OE037	L86C	0.6	
	GTL			L82C	0.6	8814
	GTV			L82C	0.6	8814
	Indiana		OE086	RL82C	0.6	8814
	Junior	1992 →	OE007	L87YC	0.6	
	Mk III / D	1970 → 1976	OE037	L86C	0.6	
	Mono		OE064	RL82YC	0.8	8814
	Sebring	1965 → 1968		L82C	0.6	8814
	Sport		OE015	N12YC	0.6	8405
	Sport Desmo		OE086	RL82C	0.6	8814
	Vento		OE037	L86C	0.6	
	XL		OE064	RL82YC	0.8	8814
400cc	M 400 Monster	2000 →	OE083	RA6HC	0.6	8809
	M 400 Monster	1995 → 1997	OE064	RL82YC	0.8	8814
	Supersport / Junior / Nuda / M 400	1991 → 1996	OE064	RL82YC	0.6	8814
450cc	Desmo , Mk III, Mk III D		OE086	RL82C	0.6	8814
	Desmo R/T		OE086	RL82C	0.6	8814
	Desmo Sport	1971 → 1974	OE086	RL82C	0.6	8814
	Regolarità		OE086	RL82C	0.6	8814
	SCR	1969 → 1974		L82C	0.6	8814
	Scrambler	1970 → 1976		L82C	0.6	8814
		T/S		OE086	RL82C	0.6
500cc	Desmo		OE086	RL82C	0.6	8814
	GTL		OE086	RL82C	0.6	8814
	GTV 5		OE086	RL82C	0.6	8814
	Pantah		OE064	RL82YC	0.8	8814
	SL		OE064	RL82YC	0.8	8814
	Sport		OE086	RL82C	0.6	8814
	Sport Desmo	1979 → 1983	OE037	L86C	0.6	
	Sport Twin	1978 →		L82C	0.6	8814
	V2		OE064	RL82YC	0.8	8814
550cc	Supermono	1993 →		QA55V		
600cc	M 600 Monster	1997 →	OE073	RA4HC	0.7	
	Monster 600 Dark, City (Air cooled)	1994 → 1996	OE083	RA6HC	0.6	8809
	Pantah 600 SL,TL		OE064	RL82YC	0.8	8814
	SS 600		OE073	RA4HC	0.6	

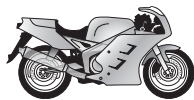
**21****POWER
SPORT****...DUCATI**

620cc	i.e.	2002 →	OE073	RA4HC	0.8		
	Monster 620 ie Dark	2002 →	OE073	RA4HC	0.8		
	Monster 620 S i.e.	2001 →	OE073	RA4HC	0.8		
	Monster 620 Sport i.e.	2003 →	OE073	RA4HC	0.8		
	Monster M 620 i.e.	2001 →	OE073	RA4HC	0.8		
	Multistrada	2005 →	OE073	RA4HC	0.8		
	Sport	2003 →	OE073	RA4HC	0.8		
650cc	Indiana		OE064	RL82YC	0.8	8814	
695cc	Monster	2007 →	OE073	RA4HC	0.7		
748cc	748 (Liquid cooled)	1995 →		RA59GC	0.6		
	749	2003 →	OE092	RG4HC	0.7	8698	
	748R (Liquid cooled)	2000 →		QA55V			
	748S (Liquid cooled)	2000 →		RA59GC	0.6		
	Biposto	1995 →		RA59GC	0.6		
	SPS			RA59GC	0.6		
	Super Sport		OE083	RA6HC	0.6	8809	
749cc	749	2002 →	OE092	RG4HC	0.7	8698	
	R, S	2003 →	OE092	RG4HC	0.7	8698	
750cc	Desmo Super Sport		OE083	RA6HC	0.6	8809	
	F1	1985 →	OE083	RA6HC	0.6	8809	
	F1 Formula		OE038	L82YC	0.8	8814	
	GT		OE064	RL82YC	0.8	8814	
	Indiana		OE064	RL82YC	0.8	8814	
	Laguna Seca		OE083	RA6HC	0.6	8809	
	LS	1985 →	OE083	RA6HC	0.6	8809	
	Monster (Air cooled)		OE083	RA6HC	0.6	8809	
	Montjuichi		OE083	RA6HC	0.6	8809	
	Montjuichi U			RA8HC	0.6	8812	
	Paso	1986 → 1992	OE083	RA6HC		8809	
	S	1988 → 1990	OE064	RL82YC	0.8	8814	
	Santa Monica		OE083	RA6HC	0.6	8809	
	SS	1972 → 1983	OE064	RL82YC	0.8	8814	
	SS Special (Air cooled)	1992 →		RA59GC	0.6		
	SS Super Sport	1991 →	OE073	RA4HC	0.7		
	SS Super Sport i.e.	1999 →	OE083	RA6HC	0.6	8809	
	Strada		OE038	L82YC	0.8	8814	
800cc	800 Sport ie HF	2003 →	OE073	RA4HC	0.7		
	800 Sport ie	2003 →	OE073	RA4HC	0.7		
	800 SS ie 2003	2003 →	OE073	RA4HC	0.7		
	800 SS ie HF	2003 →	OE073	RA4HC	0.7		
	Monster S2 R	2007 →	OE073	RA4HC	0.7		
850cc	I.E. 851		OE103	A59GC	0.6		
851cc	SP 851 Sport Production			A59C	0.6		
	Superbike 851			A59C	0.6		
	Superbike 851 Strada			A59C	0.6		
	Superbike 851 Versione Kit			QA55V			
860cc	SS Desmo		OE037	L86C	0.6		
	SS Desmo GT		OE037	L86C	0.6		
	SS Desmo GTS		OE037	L86C	0.6		
864cc	Darmah 900 SS, SD		OE064	RL82YC	0.8	8814	
	GT 900		OE064	RL82YC	0.8	8814	
	GTS 900		OE064	RL82YC	0.8	8814	
	Mike Hailwood Replica		OE037	L86C	0.6		
	Replica 900		OE064	RL82YC	0.8	8814	

**DUCATI**

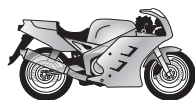
**21****POWER SPORT****...DUCATI**

...864cc	S 900		OE064	RL82YC	0.8	8814	
	S2 900		OE064	RL82YC	0.8	8814	
	SS 900		OE038	L82YC	0.8	8814	
888cc	SP1	1989 → 1994		QA55V			
	SP5			QA55V			
	Strada		OE103	A59GC	0.6		
	Supersport		OE103	A59GC	0.6		
900cc	Darmah		OE038	L82YC		8814	
	M 900 Monster	1997 →	OE083	RA6HC	0.6	8809	
	M 900 Monster i.e.	1997 →	OE083	RA6HC	0.6	8809	
	MH900E (Air cooled)	2000 →	OE083	RA6HC	0.9	8809	
	SS Super Sport	1999 → 2003	OE083	RA6HC	0.6	8809	
	SS Super Sport / SL	1991 → 1998	OE083	RA6HC	0.6	8809	
	Superlight		OE083	RA6HC	0.6	8809	
904cc	Paso Super		OE083	RA6HC	0.6	8809	
	SS Super Sport i.e.	1991 → 1998	OE083	RA6HC	0.6	8809	
	Super Sport		OE083	RA6HC	0.6	8809	
	Superlight		OE083	RA6HC	0.6	8809	
906cc	Paso	1988 → 1990	OE073	RA4HC	0.6		
907cc	I.E.		OE073	RA4HC	0.6		
916cc	Racing			RA59GC	0.6		
	S4 Monster	2001 →		RA59GC	0.6		
	Senna	1995 →		RA59GC	0.6		
	SP			QA55V			
	Sport Production			QA55V			
	SPS	1994 →		RA59GC	0.6		
	ST2 (Liquid cooled)	1997 →	OE073	RA4HC	0.6		
	ST4	1998 →		RA59GC	0.6		
944cc	ST2	2003 →	OE073	RA4HC	0.7		
950cc	Racing	1995 →		QA55V			
972cc	Mille S2, Replica		OE064	RL82YC	0.8	8814	
992cc	1000 SS ie	2003 →	OE083	RA6HC	0.7	8809	
	1000 SS ie DS	2003 →	OE083	RA6HC	0.7	8809	
	Monster i.e.	2003 →	OE083	RA6HC	0.7	8809	
	Multistrada	2003 →	OE083	RA6HC	0.7	8809	
	S2R 1000		OE083	RA6HC	0.7	8809	
	ST2	2004 →	OE083	RA6HC	0.7	8809	
	ST3	2004 →	OE092	RG4HC	0.7	8698	
996cc	996 (Liquid cooled)	2000 →		RA59GC	0.6		
	996 S / SPS	1997 →		RA59GC	0.6		
	996 SPS Race	1997 →		QA55V			
	Biposto	1999 →	OE073	RA4HC	0.6		
	ST4 S	2003 →		RA59GC	0.6		
	ST4 S-ABS	2003 →		RA59GC	0.6		
998cc	998	2003 →	OE092	RG4HC	0.7	8698	
	999 R	2003 →		RG59V			
	999 S	2003 →	OE092	RG4HC	0.7	8698	
	Monster S4 R	2007 →	OE092	RG4HC	0.7	8698	
	Monster S4 RS	2007 →	OE092	RG4HC	0.7	8698	
	Monster S4 RS	2006 → 2007	OE073	RA4HC	0.7		

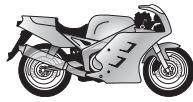
**21****POWER SPORT****...DUCATI**

1000cc	GT	2007→	OE083	RA6HC	0.7	8809
	Monster 1000 ie	2003→	OE083	RA6HC	0.7	8809
	Monster S2 R	2006→	OE083	RA6HC	0.7	8809
	Multistrada / DS	2002→2006	OE083	RA6HC	0.7	8809
	Paul Smart 1000	2006→	OE083	RA6HC	0.7	8809
	Sport	2006→	OE083	RA6HC	0.7	8809
	Sport Biposto	2007→	OE083	RA6HC	0.7	8809
	SS Super Sport	2003→	OE083	RA6HC	0.7	8809
	1100cc	Hypermotard	2007→	OE083	RA6HC	0.7
	Multistrada	2007→	OE083	RA6HC	0.7	8809
	Multistrada S	2007→	OE083	RA6HC	0.7	8809

DUCSON

50cc	Automatic 49		OE037	L86C	0.5	
	S21TT, S30TT, XL50 Mercury		OE037	L86C	0.5	
	S9, S15, S16, S20TT		OE037	L86C	0.5	

DÜRRKOPP

150cc	MD			L82C	0.5	8814
175cc	MD			L82C	0.5	8814
200cc	MD			L82C	0.5	8814
	MD			L82C	0.5	8814

EMW

350cc	R 35/3	1953→1955	OE037	L86C		
--------------	--------	-----------	--------------	------	--	--

ERING

50cc	AT		OE037	L86C		
	RT		OE037	L86C		

E-Z RIDER

	Mini Bike 3506, 3536, 3556			RJ8C	0.8	
	Mini Bike 3956, 4606			RJ8C	0.8	

FAMEL

50cc	75			L78C	0.5	8883
	76			L78C	0.5	8883
	111			L78C	0.5	8883
	278 2 speed		OE086	RL82C	0.5	8814
	280 4 speed			L78C	0.5	8883
	284 5 speed		OE086	RL82C	0.5	8814
	Super Sport		OE086	RL82C	0.5	8814
	Tricarro			L78C	0.5	8883
	TT		OE086	RL82C	0.5	8814
	XF17		OE086	RL82C	0.5	8814
	XF17 Super		OE086	RL82C	0.5	8814
	XF21		OE086	RL82C	0.5	8814
	XF25		OE086	RL82C	0.5	8814
	XS		OE086	RL82C	0.5	8814
	Z2		OE086	RL82C	0.5	8814
	2000		OE086	RL82C	0.5	8814

**FAMEL**

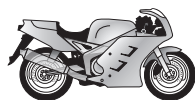
**21****POWER
SPORT****FANTIC**

50cc		1993 →		mm		
	Big Wheel		L78C	0.5	8883	
	Bip		L78C	0.5	8883	
	Caballero 50RC, 50RS		OE040 N2C	0.5	8904	
	Caballero Kid Trial		OE037 L86C	0.5		
	Caballero RC		OE091 RN2C	0.5	8904	
	Caballero RS		OE091 RN2C	0.5	8904	
	Clubman		OE068 N3C	0.5	8904	
	Competition		C59R	0.5		
	Competition GM		C59R	0.5		
	Concord XKE20, XKE25, XKE30		OE037 L86C	0.5		
	Deputy		OE037 L86C	0.5		
	Diablo Cross		OE037 L86C	0.5		
	Fast		OE108 RN3C	0.5	8904	
	Gran Turismo 4V, 6V, 4GT, Super 6GT		OE086 RL82C	0.5	8814	
	Issimo Convert / Kick		OE037 L86C	0.5		
	Junior / Tender To		OE037 L86C	0.5		
	Leader		L78C	0.5	8883	
	Lei		OE037 L86C	0.5		
	Mini Matic		OE037 L86C	0.5		
	Oasis 2		OE091 RN2C	0.6	8904	
	Pony SR		L78C	0.5	8883	
	Raider		OE098 RN4C	0.6	8339	
	Rally		OE037 L86C	0.5		
	RC 12,7mm, 1/2in.		QN84	0.5		
	RC 19mm, 3/4in.		QL77JC4	1.0	8883	
	Regolarità 4V, 6V		OE086 RL82C	0.5	8814	
	Regolarità Super 6M, Casa		OE086 RL82C	0.5	8814	
	Sprinter		OE037 L86C	0.5		
	Strada		OE108 RN3C	0.5	8904	
	Super Special		C59R	0.5		
	Super T		OE098 RN4C	0.5	8339	
	Trial		OE108 RN3C	0.5	8904	
	Trial /300		OE108 RN3C	0.5	8904	
	Trial 50.1		OE108 RN3C	0.5	8904	
	Trial 50.7		L78C	0.5	8883	
	Trial 50.9		OE108 RN3C	0.6	8904	
	Trial Kid		OE037 L86C	0.5		
	TX 182		OE086 RL82C	0.5	8814	
	TX Ranger Turismo Internazionale		OE037 L86C	0.5		
	TX6 Mini Cross		OE086 RL82C	0.5	8814	
	TX7 4-Matic		OE037 L86C	0.5		
	X9		C59R	0.5		
74cc	Clubman		OE068 N3C	0.5	8904	
75cc	Regolarità		L77JC4	1.0	8883	
	Trial 74		OE108 RN3C	0.5	8904	
	Trial 75.7,75.9		L78C	0.5	8883	
80cc	Clubman		OE108 RN3C	0.5	8904	
	Cross Competition		QN84	0.5		
	Enduro		OE108 RN3C	0.5	8904	
	RSX		OE108 RN3C	0.5	8904	
	Trial		OE091 RN2C	0.8	8904	
100cc	Caballero Cross Strada		OE108 RN3C	0.5	8904	
	Caballero TX92 Cross		OE108 RN3C	0.5	8904	

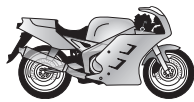

**21****POWER
SPORT****...FANTIC**

Capacity	Model	Year	Part No.	Gap (mm)	Part No.	
125cc	Caballero Cross Competizione		QN84	0.5		
	Caballero RC		C59R	0.5		
	Caballero Regolarità		QN84	0.5		
	Cross		OE091	RN2C	0.8	8904
	Enduro Comp		QN84	0.5		
	HP1		QN84	0.5		
	K-Roo		OE037	L86C	0.5	
	K-Roo		OE037	L86C	0.5	
	Professional		OE037	L86C	0.5	
	Raider			N1C	0.5	8904
	Raider LC			QN84	0.5	
	RSX		OE091	RN2C	0.5	8904
	Scrambler		OE091	RN2C	0.5	8904
	Strada		OE091	RN2C	0.5	8904
	Strada			QN84	0.5	
	Strada Sport			QN84	0.5	
	Trial		OE037	L86C	0.5	
Trial 125.5		OE108	RN3C	0.8	8904	
Trial Competition			L82C	0.5	8814	
Trial Prof.		OE037	L86C	0.5		
160cc	Trial 200		OE037	L86C	0.5	
	Trial 201		OE037	L86C	0.5	
	TX		OE078	N3G	0.5	8904
175cc	Enduro		OE078	N3G	0.5	8904
200cc	Trial			L82C	0.5	8814
210cc	K-Roo 212		OE075	C6YCC	0.8	
	Trial			L82C	0.5	8814
211cc	Trial 245		OE108	RN3C	0.5	8904
	Trial 247		OE108	RN3C	0.5	8904
212cc	Clubman		OE084	N6YCC	0.4	8902
	K-Roo		OE075	C6YCC	0.5	
240cc	Trial		OE086	RL82C	0.5	8814
	Trial Prof.		OE108	RN3C	0.5	8904
249cc	Coach		OE084	N6YCC	0.5	8902
250cc	Coach		OE084	N6YCC	0.5	8902
	K-Roo		OE084	N6YCC	0.5	8902
	K-Roo 249		OE084	N6YCC	0.8	8902
	Raider		OE091	RN2C	0.5	8904
	Raider 305		OE091	RN2C	0.5	8904
	Section	1995 → 1997	OE017	C7YC	0.5	
	Trial		OE075	C6YCC	0.8	
	TX		OE078	N3G	0.6	8904
260cc	TX		OE078	N3G	0.6	8904
300cc	Professional		OE078	N3G	0.6	8904
	Trial		OE084	N6YCC	0.5	8902
	Trial 301		OE108	RN3C	0.5	8904
	Trial 305		OE108	RN3C	0.5	8904
	Trial 307		OE108	RN3C	0.5	8904
	Trial 309		OE108	RN3C	0.5	8904
	Trial 309 Coach		OE084	N6YCC	0.5	8902
330cc	TX		OE078	N3G		8904

**FANTIC**

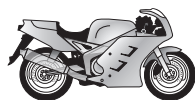
**21****FB MINARELLI (→ Minarelli)****FITE (→ LEM)****FLANDRIA****50cc**

37	OE037	L86C	0.5		
3A 127	OE037	L86C	0.5		
AFA	OE037	L86C	0.5		
Alouette	OE037	L86C	0.5		
Apollo	OE037	L86C	0.5		
Apollo AF	OE037	L86C	0.5		
Apollo FV	OE037	L86C	0.5		
Apollo R	OE037	L86C	0.5		
Bang	OE037	L86C	0.5		
Camaro	OE037	L86C	0.5		
Cambera	OE037	L86C	0.5		
Comet 4	OE037	L86C	0.5		
Concorde	OE037	L86C	0.5		
Dinky	OE037	L86C	0.5		
Dyno	OE037	L86C	0.5		
Eurolux	OE037	L86C	0.5		
F137	OE037	L86C	0.5		
Floride	OE037	L86C	0.5		
Furie	OE037	L86C	0.5		
Futura	OE037	L86C	0.5		
FV137	OE037	L86C	0.5		
FVA127	OE037	L86C	0.5		
FVA137	OE037	L86C	0.5		
Galet	OE037	L86C	0.5		
Gigi (→ 40 Kmh)	OE037	L86C	0.5		
GT627	OE037	L86C	0.5		
Hobby	OE037	L86C	0.5		
Indiana		L78C	0.5	8883	
Indiana 4M	OE037	L86C	0.5		
Libelle 3V	OE037	L86C	0.5		
Libelle A	OE037	L86C	0.5		
Libelle AF	OE037	L86C	0.5		
Mini	OE037	L86C	0.5		
Mini Eurolux	OE037	L86C	0.5		
Mirage	OE037	L86C	0.5		
Mistral	OE037	L86C	0.5		
Mondial	OE037	L86C	0.5		
Monomatic Comet	OE037	L86C	0.5		
Monza	OE037	L86C	0.5		
Parisienne	OE037	L86C	0.5		
Penny	OE037	L86C	0.5		
Polo (→ 25 Kmh)	OE037	L86C	0.5		
Primus	OE037	L86C	0.5		
Princesse	OE037	L86C	0.5		
Record	OE037	L86C	0.5		
Record 4	OE037	L86C	0.5		
Record 4M	OE037	L86C	0.5		
Record P		L78C	0.5	8883	
Record S	OE037	L86C	0.5		

FB MINARELLI (→ MINARELLI)

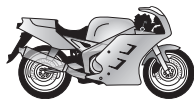
**21****POWER
SPORT****...FLANDRIA****...50cc**

Scrab 4	OE037	L86C	0.5	
Scrab 4M		L78C	0.5	8883
SP227	OE037	L86C	0.5	
SP237	OE037	L86C	0.5	
SP327	OE037	L86C	0.5	
SP427	OE037	L86C	0.5	
SP527	OE037	L86C	0.5	
SP727	OE037	L86C	0.5	
SP737	OE037	L86C	0.5	
Special	OE037	L86C	0.5	
Special 5V	OE037	L86C	0.5	
Special S	OE037	L86C	0.5	
Special V	OE037	L86C	0.5	
Sportif	OE037	L86C	0.5	
Sportif 3	OE037	L86C	0.5	
Sportif 4	OE037	L86C	0.5	
Super S	OE037	L86C	0.5	
Tornado	OE037	L86C	0.5	
Trial	OE037	L86C	0.5	
Trophee	OE037	L86C	0.5	
Vedette	OE037	L86C	0.5	
Velomat	OE037	L86C	0.5	
VS	OE037	L86C	0.5	

FN**125cc**

T	OE037	L86C	0.5	
T50	OE037	L86C	0.5	
T52	OE037	L86C	0.5	

FRIGERIO MOTO**80cc**

Enduro		QC57	0.5	
--------	--	------	-----	--

125cc

Cross		QC57	0.5	
Enduro		QC57	0.5	
Scrambler		QC57	0.5	

250cc

Cross		QC57	0.5	
Enduro		QC57	0.5	

350cc

Enduro	OE083	RA6HC	0.5	8809
Enduro 347		QC57	0.5	
Scrambler	OE083	RA6HC	0.5	8809

400cc

Enduro 406		QC57	0.5	
------------	--	------	-----	--

496cc

Cross		QC57	0.5	
-------	--	------	-----	--

500cc

Enduro 504	OE083	RA6HC	0.5	8809
Enduro 506	OE083	RA6HC	0.5	8809

FUCHS

All models	OE037	L86C	0.5	
------------	--------------	------	-----	--

FYM**50cc**

GY50		P-RZ9HC		
------	--	---------	--	--

110cc

C110		P-RZ9HC		
------	--	---------	--	--

125cc

CG125		P-RA7HC		8812
-------	--	---------	--	------

150cc

CG150		P-RA7HC		8812
CBT		P-RZ9HC		
GY6		P-RZ9HC		

**FYM**

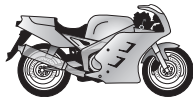
**21****POWER SPORT****G.A.C. MobyLe.**

50cc	87//89/188/188E/188TC	→1987	OE037	L86C	0.5	
	AV49R/51/69/70/70E/72/83R		OE037	L86C	0.5	
	AV87,AV90,D55, Cady/E14,Compera	1988→		L82C	0.5	8814
	Canpera,Coma First	→1987	OE037	L86C	0.5	
	D55/E/77/Cross,SP50	1988→		L82C	0.5	8814
	D55NTT,SP95R,Cady	→1987	OE037	L86C	0.5	
	Hawar,Chopper,Cross NTT,	1988→		L82C	0.5	8814
	Kanowey,Onix,			L82C	0.5	8814
	Liberty,Moby Cross,		OE037	L86C	0.5	
	MTR Top Racing,Winner		OE068	N3C	0.5	8904
	Onix ,Stylo GT,	→1987	OE037	L86C	0.5	
	Onix 2/City/Coma,Rural			L82C	0.5	8814
	SP90/90R/94/95R /96	→1987	OE037	L86C	0.5	
	Transport ,University	→1987	OE037	L86C	0.5	
	Transporter, Zarpa NTT	1988→		L82C	0.5	8814

G+G

1200cc	Cruso	2003→	OE026	RC8DMC		
	Cruso S	2003→	OE026	RC8DMC		

GARELLI

25cc	Bonanza		OE037	L86C	0.6	
35cc	Matic Kick		OE086	RL82C	0.5	8814
	Mokick Cross			RN5C	0.5	8339
	Mokick Sport			RN5C	0.5	8339
	Mosquito Kit		OE037	L86C	0.5	
	Noi models		OE086	RL82C	0.5	8814
	Nurburg R5		OE091	RN2C	0.5	8904
50cc	Basic		OE037	L86C	0.5	
	Basic		OE037	L86C	0.5	
	Bimatic (→ 25 mph/40 Km/h)		OE086	RL82C	0.5	8814
	Bimatic (25 mph/40 Km/h →)		OE037	L86C	0.5	
	Bonanza (→ 25 mph/40 Km/h)		OE086	RL82C	0.5	8814
	Bonanza (25 mph/40 Km/h →)		OE037	L86C	0.5	
	Capri Furgone		OE037	L86C	0.5	
	Ciclone Matic			RN5C	0.5	8339
	Ciclone Matic		OE091	RN2C	0.5	8904
	Concorde		OE086	RL82C	0.5	8814
	Cross		OE098	RN4C	0.5	8339
	Cross			RN5C	0.5	8339
	Cross		OE091	RN2C	0.5	8904
	Cross		OE091	RN2C	0.5	8904
	Duoped (→ 25 mph/40 Km/h)		OE086	RL82C	0.5	8814
	Duoped (25 mph/40 Km/h →)		OE037	L86C	0.5	
	Eureka Flex, Matic, K, M. (→ 25 mph/40 Km/h)		OE086	RL82C	0.5	8814
	Eureka Flex, Matic, K, M. (→ 25 mph/40 Km/h)		OE086	RL82C	0.5	8814
	Eureka Sport,Gransport,Super Sport (25 mph/40 Km/h →)		OE037	L86C	0.5	
	Eureka Sport,Gransport,Super Sport (25 mph/40 Km/h →)		OE037	L86C	0.5	
	Europed (→ 25 mph/40 Km/h)		OE086	RL82C	0.5	8814
	Europed (25 mph/40 Km/h →)		OE037	L86C	0.5	
	Flex (→ 25 mph/40 Km/h)		OE086	RL82C	0.5	8814
	Flex (25 mph/40 Km/h →)		OE037	L86C	0.5	
	Formuno		OE086	RL82C	0.5	8814
	Gary One, Two, Three		OE037	L86C	0.5	

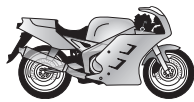
**21****POWER
SPORT****...GARELLI****...50cc**

Gary Kat One, Two, Three	OE037	L86C	0.5	
Gran Turismo		RN5C	0.5	8339
Gran Turismo (→ 25 mph/40 Kmh)	OE086	RL82C	0.5	8814
Gran Turismo	OE091	RN2C	0.5	8904
Gran Turismo (25 mph/40 Kmh →)	OE037	L86C	0.5	
Gulp (→ 25 mph/40 Kmh)	OE086	RL82C	0.5	8814
Gulp (25 mph/40 Kmh →)	OE037	L86C	0.5	
Gulp 3V (→ 25 mph/40 Kmh)	OE086	RL82C	0.5	8814
Gulp 3V (25 mph/40 Kmh →)	OE037	L86C	0.5	
Gulp 4V (→ 25 mph/40 Kmh)	OE086	RL82C	0.5	8814
Gulp 4V (25 mph/40 Kmh →)	OE037	L86C	0.5	
Gulp K (→ 25 mph/40 Kmh)	OE086	RL82C	0.5	8814
Gulp K (25 mph/40 Kmh →)	OE037	L86C	0.5	
Gulp Matic (→ 25 mph/40 Kmh)	OE086	RL82C	0.5	8814
Gulp Matic (25 mph/40 Kmh →)	OE037	L86C	0.5	
Issimo One, Two	OE037	L86C	0.5	
Junior GT	OE091	RN2C	0.5	8904
Katia M, MK, K2V (→ 25 mph/40 Kmh)	OE086	RL82C	0.5	8814
Katia M, MK, K2V (25 mph/40 Kmh →)	OE037	L86C	0.5	
KL 4V-5V		RN5C	0.5	8339
KL 4V-5V	OE091	RN2C	0.5	8904
Leader (→ 25 mph/40 Kmh)		L78C	0.5	8883
Luxus 200 (→ 25 mph/40 Kmh)	OE086	RL82C	0.5	8814
Luxus 200 (25 mph/40 Kmh →)	OE037	L86C	0.5	
Matic (→ 25 mph/40 Kmh)	OE086	RL82C	0.5	8814
Matic (25 mph/40 Kmh →)	OE037	L86C	0.5	
Mini (→ 25 mph/40 Kmh)	OE086	RL82C	0.5	8814
Mini (25 mph/40 Kmh →)	OE037	L86C	0.5	
Mokick (→ 25 mph/40 Kmh)	OE086	RL82C	0.5	8814
Mokick (25 mph/40 Kmh →)	OE037	L86C	0.5	
Noi Lusso, SL (→ 25 mph/40 Kmh)	OE086	RL82C	0.5	8814
Noi Lusso, SL (25 mph/40 Kmh →)	OE037	L86C	0.5	
Rekord		RN5C	0.5	8339
Rekord	OE091	RN2C	0.5	8904
RGS		RN5C	0.5	8339
RGS	OE091	RN2C	0.5	8904
Sahel	OE091	RN2C	0.5	8904
Scugnizzo (→ 25 mph/40 Kmh)	OE086	RL82C	0.5	8814
Scugnizzo (25 mph/40 Kmh →)	OE037	L86C	0.5	
Sport	OE086	RL82C	0.5	8814
Super Ciclone	OE091	RN2C	0.5	8904
Team	OE086	RL82C	0.5	8814
Team	OE037	L86C	0.5	
Team 3V	OE037	L86C	0.5	
Tiger		RN5C	0.5	8339
Tiger 50XLE	OE091	RN2C	0.5	8904
Urka AC, LC	OE091	RN2C	0.5	8904
Vip 1V,2V,3V,4V,2oro,3oro,4oro	OE086	RL82C	0.5	8814
Vip 1V,2V,3V,4V,2oro,3oro,4oro (25 mph/40 Kmh →)	OE037	L86C	0.5	
80cc				
Enduro		L77JC4	1.0	8883
Rekord KL100E		L77JC4	1.0	8883
125cc				
GT4 Gresini Replica	OE091	RN2C	0.5	8904
TSR	OE108	RN3C	0.5	8904
320cc				
Trial	OE045	RN11YCC	0.8	8405

**GARELLI**

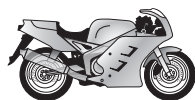
**21****POWER SPORT****GAS GAS**

50cc	Contact, Endurocross		L78C	0.6	8883	
	ec boy 50	2000 →	L78C	0.5	8883	
	ec rookie 50	2000 →	OE091 RN2C	0.6	8904	
	Endurocross BOY		OE045 RN11YCC	0.6	8405	
	TXT Boy		OE045 RN11YCC	0.6	8405	
	TXT Boy (Alu-head)	2004 →	QN86	0.6		
75cc	(Husqvarna TM)		QN84	0.5		
125cc	(Husqvarna TM)		QN84	0.5		
	Contact T 12	1994 →	OE001 N9YC	0.5	8415	
	Cross TT 125		OE040 N2C	0.5	8904	PRO-5M
	ec 125	1997 →	OE040 N2C	0.6	8904	
	Endurocross TT 125		OE040 N2C	0.5	8904	PRO-5M
	Enduro	1993 →	QN86	0.6		
	JT 12 (Water cooled)		OE045 RN11YCC	0.7	8405	
	Pampera	1996 →	OE004 RN9YCC	0.7	8415	
	Trial	1993 →	OE045 RN11YCC	0.7	8405	
	TT 125		OE078 N3G	0.6	8904	PRO-5M
	TXT 125	1999 →	OE045 RN11YCC	0.6	8405	
143cc	Contact T 16	1994 →	OE065 N11YC	0.5	8405	
160cc	JT 16 (Water cooled)		OE045 RN11YCC	0.7	8405	
200cc	200 Enduro	2002 →	OE108 RN3C	0.6	8904	
	Crosser	1999 →	C61	0.6		
	ec 200	1999 →	OE040 N2C	0.6	8904	
	Pampera 200		OE004 RN9YCC	0.8	8415	
	TT 200		OE108 RN3C	0.6	8904	PRO-5M
	TXT 200	1999 →	OE045 RN11YCC	0.6	8405	
238cc	Contact JT 25	1994 →	OE065 N11YC	0.5	8405	
240cc	GT 25	1994 →	OE001 N9YC	0.7	8415	
	JT 25 Contact		OE065 N11YC	0.7	8405	
249cc	TXT 249	1999 →	OE045 RN11YCC	0.6	8405	
250cc	(Husqvarna TM)		QN84	0.5		
	250 MC	2004 →	OE108 RN3C	0.6	8904	
	Cross 250		OE108 RN3C	0.6	8904	PRO-5M
	Crosser	1999 →	C61	0.6		
	Delta 25 GT		OE065 N11YC	0.5	8405	
	ec 250	1997 →	OE068 N3C	0.5	8904	
	Endurocross 250		OE040 N2C	0.5	8904	
	Enduro	1993 →	QN86	0.6		
	Pampera	1996 →	OE004 RN9YCC	0.7	8415	
	Piri-A 6 Magnum		OE065 N11YC	0.5	8405	
	Trial	1993 →	OE045 RN11YCC	0.7	8405	
	TT 250		OE108 RN3C	0.6	8904	PRO-5M
	TXT 250		OE045 RN11YCC	0.6	8405	
270cc	Trial	1993 →	OE045 RN11YCC	0.7	8405	
272cc	TXT 280	2000 →	OE065 N11YC	0.5	8405	
280cc	TXT 280		OE045 RN11YCC	0.6	8405	
300cc	300 Enduro	2002 →	OE108 RN3C	0.6	8904	
	Crosser	1999 →	C61	0.6		
	ec 300	1999 →	OE040 N2C	0.5	8904	
	TT 300		OE108 RN3C	0.6	8904	PRO-5M

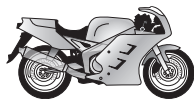
**21****POWER
SPORT****...GAS GAS**

320cc	JT 32 Contact	1995 →	OE001	N9YC	0.7	8415	
	Pampera	1997 →	OE004	RN9YCC	0.7	8415	
	Pampera 320		OE004	RN9YCC	0.8	8415	
	TX	1997 →	OE004	RN9YCC	0.7	8415	
	TXT	1999 →	OE004	RN9YCC	0.7	8415	
327cc	Trial	1993 →	OE045	RN11YCC	0.7	8405	
330cc	Delta 32 GT		OE065	N11YC	0.5	8405	
	JT 32		OE045	RN11YCC	0.7	8405	
	Trial Halley PXC 325		OE040	N2C	0.5	8904	
350cc	Enduro	1993 →		QN86	0.6		
	Pampera	1996 →	OE004	RN9YCC	0.7	8415	
	Trial	1993 →	OE045	RN11YCC	0.7	8405	
370cc	Pampera		OE045	RN11YCC	0.7	8405	
400cc	FSE 400	2002 →		RG94C	0.7	8698	
500cc	Normada 500		OE083	RA6HC	0.5	8809	

GAZELLE

35cc	FBM Laura		OE037	L86C	0.5		
	G 50		OE037	L86C	0.5		
	JLO FP50		OE037	L86C	0.5		
	Minarette		OE037	L86C	0.5		

GBM

345cc	Nevada V35		OE108	RN3C	0.6	8904	
750cc	Nevada		OE108	RN3C	0.6	8904	
992cc	Daytona Biposto		OE103	A59GC	0.6		
1064cc	California 1.1 EV		OE004	RN9YCC		8415	
	Quota 1.1S		OE004	RN9YCC		8415	

GEACE CICLOS

50cc	Cady E14		OE086	RL82C	0.5	8814	
	Campera SP95		OE086	RL82C	0.5	8814	
	Happy		OE086	RL82C	0.5	8814	
	Kanoway		OE086	RL82C	0.5	8814	
	Rural AV90		OE086	RL82C	0.5	8814	

GILERA

50cc	6V Competizione			C55R	0.5		PRO-5M
	Bullit		OE091	RN2C	0.5	8904	PRO-5M
	CB1			RN5C	0.5	8339	PRO-5M
	CBA		OE037	L86C	0.5		PRO-5M
	EC 1	1992 →	OE037	L86C	0.5		
	ECO		OE037	L86C	0.5		PRO-5M
	Fast Rider		OE091	RN2C	0.5	8904	PRO-5M
	GR2		OE098	RN4C	0.5	8339	PRO-5M
	Grande		OE037	L86C	0.5		PRO-5M
	GSA		OE037	L86C	0.5		
	R		OE091	RN2C	0.6	8904	
	R1 Rally		OE091	RN2C	0.5	8904	PRO-5M
	RA		OE074	N5C	0.5	8339	
	RC		OE091	RN2C	0.5	8904	PRO-5M
	RE		OE074	N5C	0.5	8339	PRO-5M
	RE Super			RN5C	0.5	8339	PRO-5M
	Replica 503		OE091	RN2C	0.5	8904	
	RL			RN5C	0.5	8339	PRO-5M
	RL Super		OE074	N5C	0.5	8339	PRO-5M
	RS		OE074	N5C	0.5	8339	PRO-5M

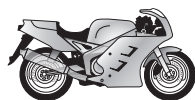

**21****POWER
SPORT****...GILERA**

...50cc	Sioux		OE091	RN2C	0.5	8904	PRO-5M
	Touring			RN5C	0.5	8339	PRO-5M
	Trend		OE037	L86C	0.5		PRO-5M
	Trial		OE098	RN4C	0.5	8339	PRO-5M
	TS		OE098	RN4C	0.5	8339	PRO-5M
75cc	Elmece Cross			QN84	0.5		PRO-5M
	Enduro			QN84	0.5		PRO-5M
	GR1 Replica			QN84	0.5		
80cc	TG2		OE091	RN2C	0.5	8904	PRO-5M
	TG3		OE091	RN2C	0.5	8904	PRO-5M
90cc	Jubilee		OE098	RN4C	0.5	8339	PRO-5M
98cc	4T 6 Giorni			C57YC	0.5		PRO-5M
	Giubileo 4T		OE108	RN3C	0.5	8904	PRO-5M
	SS		OE108	RN3C	0.5	8904	PRO-5M
123cc	Runner FX		OE091	RN2C	0.5	8904	
125cc	Agua Cross			QN84	0.5		
	Apache			QN84	0.5		PRO-5M
	Arcore , Export		OE108	RN3C	0.5	8904	PRO-5M
	Arizona		OE040	N2C	0.5	8904	
	C1			QN84	0.5		
	C3			QN84	0.5		PRO-5M
	Crono			C55CX	0.5		
	Cross Competizione Replica			QN84	0.5		PRO-5M
	CX			QN84	0.5		PRO-5M
	Endurance		OE091	RN2C	0.5	8904	PRO-5M
	Enduro			QN84	0.5		PRO-5M
	Enduro C1			QN84	0.5		PRO-5M
	Enduro E1 Competizione			QN84	0.5		PRO-5M
	ER		OE091	RN2C	0.5	8904	PRO-5M
	Fast Bike		OE091	RN2C	0.5	8904	PRO-5M
	Free Style			QN84	0.5		PRO-5M
	GFR inc Sport Production			C55CX	0.5		
	GR1		OE098	RN4C	0.5	8339	PRO-5M
	GR1 Replica		OE098	RN4C	0.5	8339	PRO-5M
	Hawk	1985 → 1986	OE091	RN2C	0.5	8904	
	HX			QN84	0.5		PRO-5M
	KK		OE091	RN2C	0.5	8904	PRO-5M
	KZ		OE091	RN2C	0.5	8904	PRO-5M
	KZ		OE091	RN2C	0.5	8904	PRO-5M
	MX1			QN84	0.5		PRO-5M
	MXR			QN84	0.5		PRO-5M
	R1			QN84	0.5		PRO-5M
	RC Rally			QN84	0.5		PRO-5M
	RC Top Rally		OE091	RN2C	0.5	8904	PRO-5M
	Regolarità			C55R	0.5		PRO-5M
	RTT Nebraska		OE091	RN2C	0.5	8904	PRO-5M
	RTX		OE040	N2C	0.5	8904	PRO-5M
	RV		OE040	N2C	0.5	8904	PRO-5M
	RX		OE040	N2C	0.5	8904	PRO-5M
	SP01			QN84	0.5		PRO-5M
	SP02			QN84	0.5		PRO-5M
	SV Regolarità			QN84	0.5		PRO-5M
	TG1		OE098	RN4C	0.5	8339	PRO-5M
	TG2	1981 → 1983	OE068	N3C	0.5	8904	

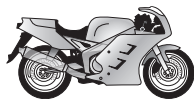
**21****POWER
SPORT****...GILERA**

...125cc	TG3	1981→1983	OE068	N3C	0.5	8904	
	XR1			QN84	0.5		PRO-5M
	XR2			QN84	0.5		PRO-5M
150cc	Arcore , Export		OE108	RN3C	0.5	8904	
200cc	Arizona			QN84	0.5		
	RTX			QN84	0.5		
	RV LC			QN84	0.5		
	RX LC			QN84	0.5		
	T4		OE108	RN3C	0.5	8904	
250cc	Arizona Rally		OE091	RN2C	0.5	8904	
	Arizona Rally KK		OE091	RN2C	0.5	8904	
	Arizona Rally KZ		OE091	RN2C	0.5	8904	
	C3			QN84	0.5		
	HX			QN84	0.5		
	NGR		OE091	RN2C	0.5	8904	
	NGR RV		OE091	RN2C	0.5	8904	
	NX LC			QN84	0.5		
350cc	Dakota / ER			RAX92YC	0.7	8809	
	ER			RAX92YC	0.7	8809	
	Nord West			RAX92YC	0.7	8809	
	XRT			RAX92YC	0.7	8809	
500cc	Dakota			RAX92YC	0.7	8809	PRO-5M
	Saturno			RAX92YC	0.7	8809	PRO-5M
	Saturno Piuma			RAX92YC	0.7	8809	PRO-5M
550cc	Nord West 600			RAX92YC	0.7	8809	
	XRT 600	1988→		RAX92YC	0.7	8809	
600cc	FB Nordcap	1992→	OE083	RA6HC	0.5	8809	
	Nord West		OE083	RA6HC	0.5	8809	
	RC , C		OE083	RA6HC	0.5	8809	

GIMSON

50cc	Cantigo TT,Cross,Jumper		OE037	L86C	0.5		
	Elite Sport/Super/E2/E87,		OE037	L86C	0.5		
	Nevada/AL,Maxi Automatico		OE037	L86C	0.5		
	Polaris,Shipper Trial,		OE037	L86C	0.5		
	Variomatic,LSA,LSA-RA		OE037	L86C	0.5		

GITANE

50cc	Camigo TT		OE037	L86C	0.5		
	Champion		OE037	L86C	0.5		
	Champion Gran Sport		OE037	L86C	0.5		
	Champion Super		OE037	L86C	0.5		
	Cricket		OE037	L86C	0.5		
	Daytona		OE037	L86C	0.5		
	Daytona Rallye		OE037	L86C	0.5		
	Dimo		OE037	L86C	0.5		
	Grand Prix		OE037	L86C	0.5		
	Grand Prix Sport		OE037	L86C	0.5		
	Polaris Super		OE037	L86C	0.5		
	Pull		OE037	L86C	0.5		
	Super		OE037	L86C	0.5		
80cc	Gran Turismo		OE037	L86C	0.5		
	Grand Prix Turismo		OE037	L86C	0.5		
125cc	Corsa		OE037	L86C	0.5		

**GITANE**

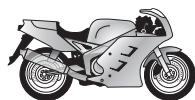
**21****POWER
SPORT****GIULIETTA PERIPOLI**

50cc	Junior		OE086	RL82C	0.5	8814
	Picobello 25		OE037	L86C	0.5	
	Sport		OE086	RL82C	0.5	8814
	Transporter			L78C	0.5	8883

GM

500cc	Longtrack			G55R	0.5	
	Speedway			G57R	0.5	

GODDEN

500cc	Longtrack			G57R	0.5	
	Speedway			G57R	0.5	

GÖRICKE

50cc	300 Ilo MM525	1970→1973		D14		
	301 AM / B F&S 50/AMB, 50/2MB	1966→1975		L82C	0.5	8814
	Moped		OE037	L86C	0.5	
500cc	Mofa		OE037	L86C	0.5	

GREEVES

500cc	360		OE108	RN3C	0.5	8904
	24 MX1			QL55	0.5	
	24 MX4			C55CX	0.5	
	24 RES			C55R	0.5	
	24 RFS			C55R	0.5	
	24 TJ		OE086	RL82C	0.5	8814
	24 TJS		OE004	RN9YCC	0.8	8415
	35 RFS			C55R	0.5	
	36 MX4		OE108	RN3C	0.5	8904
	36 MX4		OE108	RN3C	0.5	8904
	Griffon 56		OE108	RN3C	0.5	8904
	Griffon 58		OE108	RN3C	0.5	8904
	Hawkstone			QL55	0.5	
	M63A		OE108	RN3C	0.5	8904
	MX2			QL55	0.5	
Pathfinder		OE108	RN3C	0.5	8904	
RBS			QL55	0.5		
RDS			QL55	0.5		

GUANRI

125cc	CG125			P-RA7HC		8812
150cc	CG150			P-RA7HC		8812
	GN			P-RG7C		
	GZ			P-RG7C		

GUILER

	All models		OE037	L86C	0.5	
--	------------	--	--------------	------	-----	--

HARLEY DAVIDSON

50cc	M50		OE068	N3C	0.5	8904
	M50S		OE068	N3C	0.5	8904
65cc	M65		OE065	N11YC	0.6	8405
	M65S		OE065	N11YC	0.6	8405
	MC Sportster	1972→1973	OE045	RN11YCC	0.8	8405
80cc	DS		OE037	L86C	0.6	
90cc	X	1973→1974	OE045	RN11YCC	0.8	8405
	Z	1973→1974	OE045	RN11YCC	0.8	8405
100cc	Baja MSR	1970→1974	OE108	RN3C	0.5	8904
	SR	1970→1974	OE108	RN3C	0.5	8904

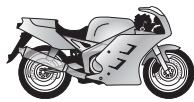
**21****POWER
SPORT****...HARLEY DAVIDSON**

125cc	M		OE045	RN11YCC	0.8	8405	
	MLS	1968 → 1974	OE045	RN11YCC	0.8	8405	
	Rapido ML		OE045	RN11YCC	0.8	8405	
	SS	1975 → 1977	OE091	RN2C	0.5	8904	
	SX	1974 →	OE098	RN4C	0.5	8339	
	SX		OE045	RN11YCC	0.8	8405	
	SXT	1975 → 1977	OE091	RN2C	0.5	8904	
175cc	Bobcat			RH8C	1.0		
	BTH			RH8C	1.0		
	Pacer			RH8C	1.0		
	Scat			RH8C	1.0		
	SS	1974 → 1977	OE091	RN2C	0.5	8904	
	SX	1974 → 1977	OE091	RN2C	0.5	8904	
250cc	Motocross	1974 → 1978	OE108	RN3C	0.5	8904	
	MX	1978 →		QN84	0.6		
	SS	1975 → 1977	OE091	RN2C	0.5	8904	
	SX	1975 → 1977	OE091	RN2C	0.5	8904	
	SX	1974 → 1975	OE108	RN3C	0.5	8904	
350cc	SS			QN84	0.6		
	SX Sprint, C, H,			QN84	0.6		
750cc	Servicar G (SV)	1934 → 1973		D14	0.6		
	W (SV)	1937 → 1951		D14	0.6		
	WL (SV)	1937 → 1951		D14	0.6		
	WLA (SV)	1941 → 1944		D14	0.6		
	WLC (SV)	1941 → 1944		D14	0.6		
	WLD (SV)	1937 → 1951		D14	0.6		
883cc	Sportster Custom XL53C (Evolution)	2000 →		RA8HC	0.6	8812	
	Sportster Hugger XLH	1985 → 1993		RA8HC	0.6	8812	
	Sportster Hugger XLH	1994 →		RA8HC	0.6	8812	
	Sportster XLH (OHV)	1985 → 1993		RA8HC	0.6	8812	
	Sportster XLH	1994 →		RA8HC	0.6	8812	
900cc	Sportster XL, XLH, XLCH	1957 → 1971		H8C	0.7		
1000cc	Café Racer XLCR	1977 → 1979		H8C	0.8		
	F (IOE)	1927 → 1929		D14	0.5		
	F (IOE)	1914 → 1926		W14	0.5		
	J (IOE)	1927 → 1929		D14	0.5		
	J (IOE)	1914 → 1926		W14	0.5		
	Knucklehead E, EL	1936 → 1947		D14	0.5		
	Panhead E, EL	1948 → 1952		J12YC	0.7		
	Sportster XL, XLH, XLCH, XLS	1980 → 1985	OE064	RL82YC	1.0	8814	
	Sportster XLH, XLCH, XLS, XLX	1971 → 1979		H8C	0.8		
	XR	1983 → 1985	OE018	RN7YC	1.0	8332	
1100cc	Evolution	1986 →		RA8HC	0.6	8812	
	XL	1986 → 1987		RA8HC	0.6	8812	
	XR	1983 → 1985		RA8HC	0.6	8812	
1130cc	VRSC V-Rod	2002 → 2006	OE073	RA4HC	0.8		
1200cc	Evolution Sportster XLC Custom	1987 →		RA8HC	0.6	8812	
	FD (IOE)	1927 → 1929		D14	0.5		
	FD (IOE)	1922 → 1926		W14	0.5		
	JD (IOE)	1927 → 1929		D14	0.5		
	JD (IOE)	1922 → 1926		W14	0.5		
	JDH (IOE)	1927 → 1929		D14	0.5		
	JDH (IOE)	1922 → 1926		W14	0.5		
	Knucklehead F, FL	1941 → 1947		D14	0.7		

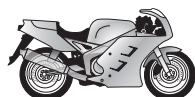
**21****POWER SPORT****...HARLEY DAVIDSON**

Capacity	Model	Year	Part No.	Gap (mm)	Part No.	
...1200cc	Panhead F, FL, FLH, FLHF	1948 → 1965	J12YC	0.7		
	Shovelhead FL, FLH, FLP, FX	1975 → 1980	OE042 RN12YC	1.0	8405	
	Shovelhead FL, FLH, FX	1948 → 1974	J12YC	0.7		
	Sportster XL S, XL C	1996 →	RA8HC	0.6	8812	
	U (SV)	1937 → 1948	D14	0.6		
	UL (SV)	1937 → 1948	D14	0.6		
	V (SV)	1930 → 1936	D14	0.6		
	VD (SV)	1930 → 1936	D14	0.6		
	VL (SV)	1930 → 1936	D14	0.6		
	VLD (SV)	1930 → 1936	D14	0.6		
	1250cc	VRSC V-Rod	2008 →	OE073 RA4HC	0.8	
VRSC V-Rod Screamin Eagle		2005 → 2007	OE073 RA4HC	0.8		
1300cc	UH (SV)	1931 → 1941	D14	0.6		
	ULH (SV)	1931 → 1941	D14	0.6		
	VLH (SV)	1931 → 1941	D14	0.6		
1340cc	Bad Boy FXSTS (Air cooled) (V-Twin)	1985 → 1999	OE042 RN12YC	1.0	8405	
	Dyna Convertible FXDS (Air cooled) (V-Twin)	1985 → 1999	OE042 RN12YC	1.0	8405	
	Dyna Low Rider FXDL (Air cooled) (V-Twin)	1985 → 1999	OE042 RN12YC	1.0	8405	
	Dyna Super Glide FXD (Air cooled) (V-Twin)	1985 → 1999	OE042 RN12YC	1.0	8405	
	Dyna Wide Glide FXDWG (Air cooled) (V-Twin)	1985 → 1999	OE042 RN12YC	1.0	8405	
	Electra Glide Classic FLHTC (Air cooled) (V-Twin)	1984 → 1999	OE042 RN12YC	1.0	8405	
	Electra Glide FLHT (Air cooled) (V-Twin)	1984 → 1999	OE042 RN12YC	1.0	8405	
	Evolution FL, FX, All models	1984 → 1999	OE042 RN12YC	1.0	8405	
	Fat Boy FLSTF (Air cooled) (V-Twin)	1984 → 1999	OE042 RN12YC	1.0	8405	
	OHV	1984 →	OE042 RN12YC	1.0	8405	
	Road King FLHR (Air cooled) (V-Twin)	1984 → 1999	OE042 RN12YC	1.0	8405	
	Road King FLHRI (Air cooled) (V-Twin)	1984 → 1999	OE042 RN12YC	1.0	8405	
	Shovelhead FL	1978 → 1981	OE042 RN12YC	1.0	8405	
	Shovelhead FL	1982 → 1983	OE156 RN13LYC	1.0		
	Shovelhead FX	1978 → 1981	OE042 RN12YC	1.0	8405	
	Shovelhead FX	1982 → 1984	OE156 RN13LYC	1.0		
	Softtail Classic FLSTC (Air cooled) (V-Twin)	1984 → 1999	OE042 RN12YC	1.0	8405	
	Softtail Custom FLSTN (Air cooled) (V-Twin)	1984 → 1999	OE042 RN12YC	1.0	8405	
	Softtail Special FLSTN (Air cooled) (V-Twin)	1984 → 1999	OE042 RN12YC	1.0	8405	
	Springer Softtail FXSTS (Air cooled) (V-Twin)	1985 → 1999	OE042 RN12YC	1.0	8405	
	Ultra Classic FLHTCU (Air cooled) (V-Twin)	1984 → 1999	OE042 RN12YC	1.0	8405	
1450cc	Dyna Low Rider FXDL (Twin Cam 88)	2000 → 2006	RA8HC	0.6	8812	
	Dyna Super Glide FXD (Twin Cam 88)	1999 → 2006	RA8HC	0.6	8812	
	Dyna Super Glide Sport FXDX (Air cooled) (Twin Cam 88)	2000 → 2006	RA8HC	0.6	8812	
	Dyna Super Glide T Sport FXDXT (Air cooled) (Twin Cam 88)	2000 → 2006	RA8HC	0.6	8812	
	Dyna Wide Glide FXDWG (Twin Cam 88)	2000 → 2006	RA8HC	0.6	8812	
	Electra Glide Standard FLHT (Twin Cam 88)	2000 → 2006	RA8HC	0.6	8812	
	Electra Glide Ultra Classic FLHTCU (Twin Cam 88)	2000 → 2006	RA8HC	0.6	8812	
	Fat Boy FLSTF, FLSTFI (Twin Cam 88)	2000 → 2006	RA8HC	0.6	8812	
	Heritage Softtail Classic FLSTC, FLSTCI (Twin Cam 88)	2000 → 2006	RA8HC	0.6	8812	
	Heritage Springer FLSTS (Twin Cam 88)	2000 → 2006	RA8HC	0.6	8812	
	Night Train FXSTB (Twin Cam 88)	2000 → 2006	RA8HC	0.6	8812	
	Road Glide FLTRI (Twin Cam 88)	2000 → 2006	RA8HC	0.6	8812	
	Road King Classic FLHRCI (Twin Cam 88)	2000 → 2006	RA8HC	0.6	8812	
	Road King FLHR (Twin Cam 88)	2000 → 2006	RA8HC	0.6	8812	
	Softail Deuce FXSTD, FXSTDI (Air cooled) (Twin Cam 88)	2000 → 2006	RA8HC	0.6	8812	
	Softail Standard FXST (Twin Cam 88B)	2000 → 2006	RA8HC	0.6	8812	
	Springer Softtail FXSTS (Twin Cam 88)	2000 → 2006	RA8HC	0.6	8812	

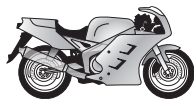
**21****POWER SPORT****...HARLEY DAVIDSON**

1584cc	Dyna	2007→	RABHC	0.6	8812	
	Softail	2007→	RABHC	0.6	8812	
	Touring	2007→	RABHC	0.6	8812	

HD CAGIVA (→ Cagiva)**HEATH KIT**

All Models Mini Bike

RCJ8

0.8

HELKAMA

CH30

OE037

L86C

0.5

Raisu

OE037

L86C

0.5

Sachs 502A1

OE037

L86C

0.5

HERKULES

30cc	Saxonette	1987→	RJ14YC	0.5			
50cc	220 PL		OE037	L86C	0.8	PRO-5M	
	221 MEH		OE037	L86C	0.8	PRO-5M	
	222 MF		OE037	L86C	0.8	PRO-5M	
	222 TH		OE037	L86C	0.8	PRO-5M	
	222 TS		OE037	L86C	0.8	PRO-5M	
	CB1		OE037	L86C	0.8	PRO-5M	
	City Bike C1	1972→1978	OE037	L86C	0.7	PRO-5M	
	City Bike C2	1972→1978	OE037	L86C	0.7	PRO-5M	
	City Bike C3	1974→1978	OE037	L86C	0.7	PRO-5M	
	Corvette		OE037	L86C	0.8	PRO-5M	
	CV Roller		OE064	RL82YC	0.8	8814	PRO-5M
	Grey Wolf		OE037	L86C	0.8	PRO-5M	
	Hercumotor Mk I		OE037	L86C	0.8	PRO-5M	
	Hercumotor Mk II		OE037	L86C	0.8	PRO-5M	
	Hobby Rider HR 1	1972→1987	OE037	L86C	0.7	PRO-5M	
	Hobby Rider HR 2	1972→1987	OE037	L86C	0.7	PRO-5M	
	Jogging		OE037	L86C	0.5	PRO-5M	
	K GS			L78C	0.6	8883	PRO-5M
	K RC			L78C	0.6	8883	PRO-5M
	K RL (Liquid cooled)		OE091	RN2C	0.6	8904	PRO-5M
	K RLC			L78C	0.6	8883	PRO-5M
	K RX			L78C	0.6	8883	PRO-5M
	K Sprint			L78C	0.6	8883	PRO-5M
	K SX (Liquid cooled)		OE091	RN2C	0.6	8904	PRO-5M
	K Ultra			L78C	0.6	8883	PRO-5M
	K Ultra LC			L78C	0.6	8883	PRO-5M
	KE SE			L78C	0.6	8883	PRO-5M
KS			L78C	0.6	8883	PRO-5M	
KX5	1986→	OE038	L82YC	0.8	8814	PRO-5M	
Lastboy		OE037	L86C	0.8		PRO-5M	
M1	1972→1977	OE037	L86C	0.5		PRO-5M	
M2	1972→1977	OE037	L86C	0.5		PRO-5M	
M4	1974→1978	OE037	L86C	0.5		PRO-5M	
M5	1974→1978	OE037	L86C	0.5		PRO-5M	
MF1		OE037	L86C	0.8		PRO-5M	
MF2		OE037	L86C	0.8		PRO-5M	
MK 1S	1978→1980	OE037	L86C	0.5		PRO-5M	
MK 2S	1978→1980	OE037	L86C	0.5		PRO-5M	
MP 2	1972→1977	OE037	L86C	0.5		PRO-5M	
MP 4	1972→1977	OE037	L86C	0.5		PRO-5M	

**HERKULES**

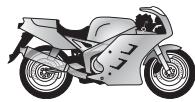
**21****POWER
SPORT****...HERKULES**

Capacity	Model	Year	OE Part	Part No.	Gap (mm)	Part No.	Part No.
...50cc	MP1		OE037	L86C	0.8		PRO-5M
	MX1	1989 →	OE037	L86C	0.8		PRO-5M
	Optima 3	1978 →	OE037	L86C	0.5		PRO-5M
	Optima 50			RL78C	0.5	8883	PRO-5M
	Prima 2, 2S, 3, 3S, 5SE		OE037	L86C	0.8		PRO-5M
	Prima 4, 5, 6		OE037	L86C	0.8		PRO-5M
	Prima Presto, Pronto		OE037	L86C	0.8		PRO-5M
	Prima S, SL, SX, GX, G3, GT		OE037	L86C	0.8		PRO-5M
	Splinter		OE038	L82YC	0.6	8814	PRO-5M
	Sport Bike SB1	1972 → 1974		L78C	0.5	8883	PRO-5M
	Sport Bike SB2	1972 → 1979	OE037	L86C	0.5		PRO-5M
	Sport Bike SB3	1974 → 1979	OE037	L86C	0.5		PRO-5M
	Sport Bike SB5	1974 → 1976		L78C	0.5	8883	PRO-5M
	Supra 2D, 3D		OE037	L86C	0.8		PRO-5M
	Supra 4		OE037	L86C	0.8		PRO-5M
	Supra Enduro		OE037	L86C	0.8		PRO-5M
	Ultra			QN84	0.6		PRO-5M
	XE5	1986 →	OE038	L82YC	0.8	8814	PRO-5M
	ZX1		OE098	RN4C	0.6	8339	PRO-5M
80cc	AC Chopper			L78C	0.6	8883	PRO-5M
	CV City Roller	1982 →		QL78C	0.6	8883	PRO-5M
	CV E City Roller	1982 →	OE064	RL82YC	0.8	8814	PRO-5M
	RS AC			L78C	0.6	8883	PRO-5M
	RX9			L78C	0.6	8883	PRO-5M
	SR Samba			L78C	0.6	8883	PRO-5M
	Ultra 80, LC, AC, 80F, 80 Chopper			L77JC4	1.0	8883	PRO-5M
	XE9	1982 →		L78C	0.6	8883	PRO-5M
	100cc	K			L78C	0.6	8883
K X			OE037	L86C	0.8		PRO-5M
K101			OE037	L86C	0.8		PRO-5M
K102			OE037	L86C	0.8		PRO-5M
K103 S			OE037	L86C	0.8		PRO-5M
K105 X				L78C	0.6	8883	PRO-5M
125cc		BW Military			QN84	0.6	
	GS			QN84	0.6		PRO-5M
	K T		OE040	N2C	0.5	8904	PRO-5M
	K X			L78C	0.5	8883	PRO-5M
	MC			QN84	0.6		PRO-5M
	S			QN84	0.6		PRO-5M
	SR Samba	1994 →	OE007	L87YC	0.6		PRO-5M
175cc	GS			QN84	0.6		PRO-5M
	SE F, S		OE037	L86C	0.8		PRO-5M
250cc	GS			QN84	0.6		PRO-5M
294cc	W 2000 (Wankel)		OE108	RN3C	0.5	8904	PRO-5M
350cc	GS			QN84	0.6		PRO-5M
HESKETH							
1000cc	V		OE083	RA6HC	0.7	8809	
HIGHLAND							
450cc	450MX			RG94C	0.6	8698	
	Allroad			RG94C	0.6	8698	
	Outback			RG94C	0.6	8698	
	Super Motard			RG94C	0.6	8698	
750cc	Diri Trac			RG94C	0.6	8698	
950cc	Dessert Strom			RG94C	0.6	8698	

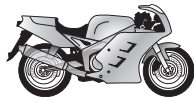
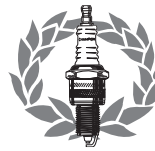
**21****POWER
SPORT****HIRO MOTORI**

125cc	All models			QC57	0.5		
	ST (Water cooled)		OE091	RN2C	0.6	8904	
250cc	All models			C55	0.5		
320cc	Sammy Miller		OE015	N12YC	0.8	8405	

HM RACING

50cc	Baja SX	1998 →	OE068	N3C	0.5	8904	
	CRX Junior & Senior	2001 →		L78C	0.5	8883	
	CRX Racing Junior & Senior	2001 →		L78C	0.5	8883	
	Derapage	1998 →	OE068	N3C	0.5	8904	
	MX Junior & Senior	2001 →		L78C	0.5	8883	
	Six	1998 →	OE068	N3C	0.5	8904	

HMW

50cc	50N De Luxe N		OE037	L86C	0.5		
-------------	---------------	--	--------------	------	-----	--	--

HMZ

125cc	Cruise 125	1996 →	OE083	RA6HC	0.6	8809	
--------------	------------	--------	--------------	-------	-----	-------------	--

HODAKA

100cc	ACE			RJ6C	0.5		
	ACE 90			RJ6C	0.5		
	ACE MX			RJ6C	0.5		
	Super Rat			QL55	0.4		

125cc	Wombat Combat		OE086	RL82C	0.5	8814	
--------------	---------------	--	--------------	-------	-----	-------------	--

HONDA

50cc	Aero, Gyro, Spree			Z9Y	0.6		
	Amigo 11			Z6	0.6		
	Amigo C50			Z6	0.6		
	Amigo CD50 Sport		OE064	RL82YC	0.8	8814	
	Bali (AF32)	1994 →	OE064	RL82YC	0.8	8814	
	C 310			RZ96C	0.6		
	C 311 (CDI)	1982 →		RZ96C	0.6		
	C 321	1984 →		P-RZ9HC	0.6		
	C DMC Super Cub J (CDI)	1982 →		RZ96C	0.6		
	C E Super Cub	1967 →		RZ96C	0.6		
	C L, LA			RZ96C	0.6		
	C SDX Super Cub J			RZ96C	0.6		
	Camino (PA50)		OE064	RL82YC	0.8	8814	
	Camino Sport VLC, L (PA50)		OE064	RL82YC	0.8	8814	
	Canguro		OE064	RL82YC	0.8	8814	
	CB J, S			P-RZ9HC	0.7		PRO-5M
	CB Y	1973 → 1983		P-RZ9HC	0.7		PRO-5M
	CD			RZ96C	0.7		
	CF Chaly			Z9Y	0.6		
	CF II			RZ96C	0.7		PRO-5M
	CF III			Z9Y	0.6		PRO-5M
	CL			Z9Y	0.6		
	CR L, LA			Z9Y	0.6		
	CR R		OE091	RN2C	0.6	8904	
	CRM		OE091	RN2C	0.6	8904	
	CS			Z9Y	0.6		
	CT			Z9Y	0.6		
	CY	1981 →		P-RZ9HC	0.7		PRO-5M
	CY (CY50)	1980 → 1985		Z9Y	0.6		PRO-5M
	Dax ST, G (ST50)			P-RZ9HC	0.7		PRO-5M
	Dream	1997 →		RGU94C	0.8	8698	

**HONDA**

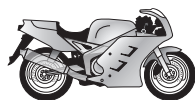
**21****POWER
SPORT****...HONDA****...50cc**

Elite S		OE064	RL82YC	0.8	8814	PRO-5M
GP DIO	1991 →	OE064	RL82YC	0.5	8814	
Lead Roller (AF01)		OE064	RL82YC	0.8	8814	
MB F		OE091	RN2C	0.6	8904	PRO-5M
MB M (AC01)		OE086	RL82C	0.6	8814	PRO-5M
MB S (AC01)		OE086	RL82C	0.6	8814	PRO-5M
MBX M, Junior (AC05)	1985 →1987		RN5C	0.6	8339	PRO-5M
MBX S (AC05)			RN5C	0.6	8339	PRO-5M
MBX SD (AC05)	1985 →1987	OE091	RN2C	0.6	8904	PRO-5M
MCX		OE091	RN2C	0.6	8904	
ME			RL86C	0.6		
Melody Roller (AB07)	1984 →	OE064	RL82YC	0.8	8814	
MR			RL86C	0.6		PRO-5M
MT (AD01)	1980 →1984	OE086	RL82C	0.6	8814	PRO-5M
MT F (AD04)			RN5C	0.6	8339	PRO-5M
MT S (AD04)			QL78C	0.6	8883	PRO-5M
MTX R (AD04)	1986 →	OE086	RL82C	0.6	8814	
MTX S (AD04)	1986 →	OE108	RN3C	0.6	8904	
NA		OE059	L92YC	0.6		
NC		OE059	L92YC	0.6		PRO-5M
ND		OE059	L92YC	0.6		
NE			RL86C	0.6		PRO-5M
NE Vision		OE064	RL82YC	0.8	8814	PRO-5M
NF		OE059	L92YC	0.6		
NP		OE059	L92YC	0.6		
NS D, MS Mokick		OE059	L92YC	0.6		
NS F		OE091	RN2C	0.6	8904	
NS Montesa		OE108	RN3C	0.6	8904	
NSR 2P Mokick (AC08)	1989 →		RN5C	0.6	8339	PRO-5M
NT		OE064	RL82YC	0.8	8814	PRO-5M
NV Stream		OE059	L92YC	0.6		
NX, NXM		OE064	RL82YC	0.8	8814	PRO-5M
NZ Leader		OE064	RL82YC	0.8	8814	
P L			Z9Y	0.6		PRO-5M
PA (PA50)		OE064	RL82YC	0.8	8814	PRO-5M
PCK1	1970 →1988		RZ96C	0.6		
PF			Z9Y	0.6		PRO-5M
PF M			L78C	0.6	8883	PRO-5M
PF R, DXR Amigo, Novio			RZ96C	0.6		PRO-5M
PM			RL86C	0.6		PRO-5M
PS			Z9Y	0.6		
PZ			RL86C	0.6		PRO-5M
QA			Z9Y	0.6		
QR		OE059	L92YC	0.6		
S Roller (AB23)			Z9Y	0.6		
SA M Vision Roller (AF29)	1992 →	OE064	RL82YC	0.8	8814	PRO-5M
SB Roller (AF29)	1992 →	OE064	RL82YC	0.8	8814	
SE Roller (AF29)	1992 →	OE064	RL82YC	0.8	8814	PRO-5M
SS M Roller			Z9Y	0.6		
SS V, ZK2 Roller			Z9Y	0.6		
SS Z			P-RZ9HC	0.6		
ST C Dax (AB23)	1989 →		P-RZ9HC	0.7		PRO-5M
TG		OE064	RL82YC	0.8	8814	
TL			Z9Y	0.6		

**HONDA**

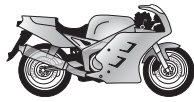
**21****POWER SPORT****...HONDA**

...50cc	TLM		OE108	RN3C	0.6	8904	
	XE			Z9Y	0.6		
	XE II			Z9Y	0.6		
	XL S	1980 →		P-RZ9HC	0.7		PRO-5M
	XR / XRR	1993 →		P-RZ9HC	0.7		PRO-5M
	XR8	1997 →		RL86C	0.6		PRO-5M
	Z GZ	1994 →		P-RZ9HC	0.7		PRO-5M
	Z J	1980 → 1984		P-RZ9HC	0.7		PRO-5M
	Z R	1993 →		P-RZ9HC	0.7		PRO-5M
	ZB P (AB22)	1988 →		P-RZ9HC	0.7		PRO-5M
55cc	CA 105 T			Z9Y	0.6		
	SE		OE064	RL82YC	0.8	8814	
60cc	CR R		OE091	RN2C	0.6	8904	
65cc	C			RZ96C	0.6		
	CA			RZ96C	0.6		
	CD M			Z9Y	0.6		
	CL			RZ96C	0.6		
	CS			RZ96C	0.6		
70cc	AT			Z9Y	0.6		
	ATC	1973 → 1981		RZ96C	0.7		
	ATC	1981 →		RZ96C	0.7		
	C			RZ96C	0.6		
	C E Super Cub			RZ96C	0.6		
	C M (CDI)			RZ96C	0.6		
	CA			Z9Y	0.6		
	CD			RZ96C	0.6		
	CF			Z9Y	0.6		
	CF II			Z9Y	0.6		
	CL			Z9Y	0.6		
	CR III			Z9Y	0.6		
	CS			Z9Y	0.6		
	CT	1992 →		P-RZ9HC	0.7		
	Cub			RZ96C	0.6		
	LS			Z9Y	0.6		
	MD			Z9Y	0.6		
	Mini			Z9Y	0.6		
	SL			Z9Y	0.6		
	ST DAX	1971 → 1994		RZ96C	0.7		
	ST DAX	1994 →		P-RZ9HC	0.7		
	Trail			Z9Y	0.6		
	Trail			Z9Y	0.6		
	XL			Z9Y	0.6		
	XR R V	1996 →		P-RZ9HC	0.6		
75cc	CE			Z9Y	0.6		
	MBX Montesa		OE108	RN3C	0.6	8904	
	MBX SWD		OE108	RN3C	0.6	8904	
	MTX Montesa		OE108	RN3C	0.6	8904	
	MTX R		OE108	RN3C	0.6	8904	
	MTX R Montesa		OE108	RN3C	0.6	8904	
	NF		OE059	L92YC	0.6		
	NS Montesa		OE108	RN3C	0.6	8904	
	NS-1 NSR	1995 →	OE091	RN2C	0.6	8904	PRO-5M
	SA Vision	1988 →	OE064	RL82YC	0.8	8814	
	SH Scoopy		OE064	RL82YC	0.8	8814	

**HONDA**

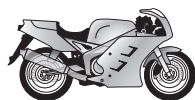
**21****POWER
SPORT****...HONDA**

...75cc	XE		Z9Y	0.6		
	XL II		Z9Y	0.6		
	XL K		Z9Y	0.6		
	XR K		Z9Y	0.6		
	YR		Z9Y	0.6		
80cc	C		Z9Y	0.6		
	CH		Z9Y	0.6		
	CR	1985→	OE091 RN2C	0.6	8904	
	CR R	1986→	C55R	0.6		
	CR RII	1984→	OE091 RN2C	0.6	8904	
	CY (HD01)		OE064 RL82YC	0.8	8814	PRO-5M
	CY		RZ96C	0.7		PRO-5M
	Lead NH (HD01)		OE064 RL82YC	0.8	8814	PRO-5M
	MB 80 ,S (HC01)	1980→1985	QL78C	0.6	8883	PRO-5M
	MBX DX (HC04)	1987→	OE091 RN2C	0.6	8904	PRO-5M
	MBX K		OE091 RN2C	0.6	8904	PRO-5M
	MCX (HC05)	1980→	OE091 RN2C	0.6	8904	PRO-5M
	MT F (HD02)	1980→1985	QL78C	0.6	8883	PRO-5M
	MT S (HD02)	1980→1985	QL78C	0.6	8883	PRO-5M
	MTX C (HD08)		OE091 RN2C	0.6	8904	PRO-5M
	MTX R / RII (HD08 / HD09)	1983→	OE091 RN2C	0.6	8904	PRO-5M
	MTX RD (HD08)		OE091 RN2C	0.6	8904	PRO-5M
	MTX RF (HD06)	1982→	QL78C	0.6	8883	PRO-5M
	MTX RS (HD09)	1987→	OE091 RN2C	0.6	8904	PRO-5M
	NSR		OE108 RN3C	0.6	8904	PRO-5M
	SH Scoopy (SH80)	1984→	OE064 RL82YC	0.8	8814	PRO-5M
	XL S		Z9Y	0.6		
	XR R	1992→1995	RZ96C	0.7		PRO-5M
	XR R	1995→	RZ96C	0.6		PRO-5M
85cc	CR85R/R2	2003→	OE091 RN2C	0.6	8904	
90cc	C (12mm)		Z9Y	0.6		
	C D, Z, GB1		P8Y	0.6		
	CA (12mm)		P8Y	0.6		
	CB		OE073 RA4HC	0.6		
	CB JX		OE073 RA4HC	0.6		
	CD (10mm)		Z9Y	0.6		
	CD (12mm)		P8Y	0.6		
	CS		P8Y	0.6		
	CT K		P7	0.6		
	EZ		OE108 RN3C	0.6	8904	PRO-5M
	L I/II, Z		P8Y	0.6		
	MD		Z9Y	0.6		
	NH Yuppy		OE064 RL82YC	0.8	8814	PRO-5M
	S		P8Y	0.6		PRO-5M
	S Z		P7	0.6		PRO-5M
	SB		P8Y	0.6		
	SL		P7	0.6		
	T K		P7	0.6		
100cc	CB		OE073 RA4HC	0.6		
	CB N		RA2HC	0.6		
	CL		OE073 RA4HC	0.6		
	GL		OE073 RA4HC	0.6		
	H		L78C	0.6	8883	
	H SII		OE086 RL82C	0.6	8814	

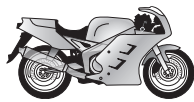
**21****POWER
SPORT****...HONDA**

...HONDA							
...100cc	MB		OE086	RL82C	0.6	8814	
	XL		OE073	RA4HC	0.6		
	XL (S M 10mm)			Z9Y	0.6		
	XL (S M 12mm)		OE073	RA4HC	0.6		
	XR R	1992→		RZ96C	0.7		
110cc	ATC	1982→		RZ94C	0.7		
	CB N		OE073	RA4HC	0.6		
	CG		OE083	RA6HC	0.7	8809	
	CT		OE073	RA4HC	0.6		
	S		OE083	RA6HC	0.6	8809	
125cc	@NES	2000→		RGU94C	0.9	8698	
	AT	1999→		RGU94C	0.9	8698	
	C Rebel (JC26)	1997→		P-RZ9HC	0.6		
	CA Rebel (JC24)	1995→		P-RZ9HC	0.6		
	CB			Z6	0.6		
	CB D, RS			P7	0.6		
	CB DC			RA2HC	0.6		
	CB J, JX			RZ94C	0.7		
	CB K			RAX92C	0.7	8809	
	CB N (CB125T)	1980→1985		Z6	0.6		
	CB S		OE083	RA6HC	0.7	8809	
	CB T			Z6	0.6		
	CB Twin II (CN125J)	1980→1985	OE073	RA4HC	0.6		
	CB XJ (12mm)			P7	0.6		
	CB Y			RAX92C	0.7	8809	
	CBR R	2004→2006	OE092	RG4HC	0.7	8698	
	CBR R	2007→		RG94C	0.7	8698	
	CBX		OE073	RA4HC	0.6		
	CC		OE083	RA6HC	0.7	8809	
	CD T			RZ96C	0.7		
	CG (JC27)	1998→	OE083	RA6HC	0.7	8809	
	CG		OE073	RA4HC	0.6		
	CJ			Z9Y	0.6		
	CLR City Fly	2000→	OE083	RA6HC	0.8	8809	
	CM			Z9Y	0.6		
	CM C Custom (JC05)			RZ96C	0.7		
	CM C, T	1994→		RZ96C	0.7		
	CR		OE091	RN2C	0.6	8904	PRO-5M
	CR R		OE091	RN2C	0.6	8904	PRO-5M
	CRM	1989→	OE091	RN2C	0.6	8904	
	CT		OE083	RA6HC	0.7	8809	
	GL		OE073	RA4HC	0.6		
	Italia I		OE083	RA6HC	0.7	8809	
Lead Roller (JF01)	1983→	OE064	RL82YC	0.8	8814	PRO-5M	
MBX, RW		OE091	RN2C	0.6	8904	SRO-5U	
MBX F		OE091	RN2C	0.6	8904	SRO-5U	
MT		OE091	RN2C	0.6	8904		
MTX		OE091	RN2C	0.6	8904		
MTX R, R2		OE091	RN2C	0.6	8904	PRO-5M	
NS F, R		OE091	RN2C	0.6	8904	PRO-5M	
NSR R, F		OE091	RN2C	0.6	8904	PRO-5M	
NX Transcity (JF01)	1995→		RAX92C	0.6	8809		
RSCMT			QN84	0.6			
S I		OE083	RA6HC	0.6	8809		

**HONDA**

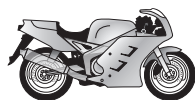
**21****POWER SPORT****...HONDA**

Capacity	Model	Year	OE Part	Part	mm	Part	Part
...125cc	SL (SL125S)	1980 → 1985	OE073	RA4HC	0.6		
	TG		OE083	RA6HC	0.6	8809	
	TL	1980 → 1984	OE083	RA6HC	0.7	8809	
	Tri-Moto		OE083	RA6HC	0.6	8809	
	Varadero 125 V2	2001 →		RGU94C		8698	
	VT C Shadow	1999 →		RGU94C	0.9	8698	
	XL R, S (XL125)		OE083	RA6HC	0.7	8809	
	XL RZ, X (XL125)	1980 → 1985	OE073	RA4HC	0.6		
	XL V	2007 →		RGU94C	0.9	8698	
	XLR	1997 →	OE083	RA6HC	0.9	8809	
	XR		OE083	RA6HC	0.7	8809	
	XR L	2003 →		RAX92YC	0.9	8809	
	XR L (ED)	2003 →	OE083	RA6HC	0.9	8809	
135cc	HX135		OE108	RN3C	0.6	8904	
	HX135 Raider		OE073	RA4HC	0.6		
145cc	GL		OE073	RA4HC	0.6		
150cc	@NES	2000 →		RGU94C	0.9	8698	
	AT	1999 →		RGU94C	0.9	8698	
	CH D		OE083	RA6HC	0.6	8809	
	Pantheon	1999 →	OE091	RN2C	0.6	8904	
175cc	CB K			P7	0.6		
	CD A, T			P7	0.6		
	MR K		OE098	RN4C	0.6	8339	
	XL 12mm		OE098	RN4C	0.6	8339	
	XL 13mm		OE083	RA6HC	0.6	8809	
185cc	CD T			RZ96C	0.7		
	CM T (CM185T)	1978 →		RZ96C	0.7		
	CT		OE073	RA4HC	0.6		
	XL S	1979 →	OE083	RA6HC	0.7	8809	
195cc	CD			Z6	0.6		
200cc	C			P7	0.6		
	CB		OE083	RA6HC	0.7	8809	
	CD T			RZ96C	0.7		
	CL		OE073	RA4HC	0.6		
	CM T			RZ96C	0.7		
	MH D	1983 →	OE108	RN3C		8904	
	MTX (MD07)	1982 → 1986	OE091	RN2C	0.6	8904	
	MTX R, RW (MD07)	1982 → 1986	OE091	RN2C	0.6	8904	
	MTX RW (MD07)	1982 → 1986	OE091	RN2C	0.6	8904	
	TLM R		OE108	RN3C	0.6	8904	
	TLR R		OE083	RA6HC	0.7	8809	
	TR Fat Cat		OE083	RA6HC	0.7	8809	
	XL R	1983 →	OE083	RA6HC	0.7	8809	
	XR	→ 1983		RAX92C	0.8	8809	
	XR	1987 →		RAX92C	0.7	8809	
	XR	1984 → 1986	OE073	RA4HC	0.6		
	XR R	→ 1983		RAX92C	0.7	8809	
	XR R	1994 →		RAX92C	0.7	8809	
	XR R	1984 →	OE073	RA4HC	0.6		
	XXL R	1983 →		RAX92C	0.8	8809	
220cc	TLM R		OE108	RN3C	0.6	8904	
240cc	TLM R		OE108	RN3C	0.6	8904	

HONDA

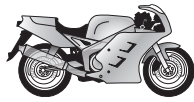
**21****POWER
SPORT****...HONDA****250cc**

C (CB250)	1980→1985	OE108	RN3C	0.6	8904	
CA			Z9Y	0.6		
CB (MC26)	1995→		P-RZ9HC	0.7		
CB F	2004→		RGU94C	0.9	8698	
CB G (CB250)		OE108	RN3C	0.6	8904	
CB K4, G5		OE083	RA6HC	0.9	8809	
CB N Dreamhawk, Hawk		OE108	RN3C	0.6	8904	
CB Nighthawk	1980→	OE083	RA6HC	0.7	8809	
CB RS	1992→		P-RZ9HC	0.7		
CB RS-A (MC02)	1980→1985	OE083	RA6HC	0.7	8809	
CB T (MC02)	1980→1985	OE083	RA6HC	0.7	8809	PRO-5M
CB Two Fifty (CB250)		OE083	RA6HC	0.7	8809	PRO-5M
CBX		OE083	RA6HC	0.7	8809	
CD U			P-RZ9HC	0.7		
CH		OE083	RA6HC	0.6	8809	
CH Spacy	1985→	OE083	RA6HC	0.9	8809	
CJ T (CJ250)	1980→1984	OE108	RN3C	0.6	8904	
CL R		OE073	RA4HC	0.6		
CL SC (MD04)		OE073	RA4HC	0.6		
CM C		OE083	RA6HC	0.7	8809	
CM T (MC06)	1982→		RZ96C	0.7		
CMX C Rebel / CT (MC13)	1996→		P-RZ9HC	0.7		
CN Fusion I		OE083	RA6HC	0.9	8809	
CR	1987→	OE091	RN2C	0.6	8904	PRO-5M
CR R	2005→	OE091	RN2C	0.6	8904	PRO-5M
CR R	→1981	OE091	RN2C	0.6	8904	PRO-5M
CR R, M	1982→2004	OE108	RN3C	0.6	8904	PRO-5M
CRF R	2004→2004			0.9	8698	
CRM R		OE091	RN2C	0.6	8904	
CS		OE073	RA4HC	0.6		
CT		OE073	RA4HC	0.6		
EX			RZ96C	0.7		
GB	1988→	OE083	RA6HC	0.9	8809	
MR		OE108	RN3C	0.6	8904	
MT		OE108	RN3C	0.6	8904	
MVX		OE108	RN3C	0.6	8904	
MVX S		OE108	RN3C	0.6	8904	
NSR, F			QN84	0.6		
NX Dominator (MD25)	1991→	OE092	RG4HC	0.9	8698	
NX J (MD21)	1988→	OE092	RG4HC	0.9	8698	
NX K (MD21)	1989→	OE092	RG4HC	0.9	8698	
NX L (MD25)	1991→	OE092	RG4HC	0.9	8698	
RSCMT			QN84	0.6		
RTL S	1985→		RA8HC		8812	
RX Silk Road		OE083	RA6HC	0.7	8809	
SL		OE083	RA6HC	0.7	8809	
T			Z9Y	0.6		
TL			P-RA7HC	0.7	8812	
TLM R	1988→	OE079	N4C		8339	
TLR		OE073	RA4HC	0.9		
VT F2		OE083	RA6HC	0.9	8809	
VTR	1989→1990		RGU94C	0.9	8698	
VTR	→1988	OE083	RA6HC	0.9	8809	
VTZ	1988→	OE083	RA6HC	0.9	8809	

**HONDA**

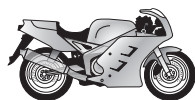
**21****POWER SPORT****...HONDA**

Capacity	Model	Year	Part No.	Thread	Gap (mm)	Part No.	Part No.	
...250cc	XL S, L (MD11)	1973→1983	OE083	RA6HC	0.7	8809	SRO-5U	
	XLR (MD11)	→1983	OE083	RA6HC	0.7	8809	SRO-5U	
	XLR (MD11)	1984→	OE073	RA4HC	0.6		SRO-5U	
	XLX		OE083	RA6HC	0.9	8809	SRO-5U	
	XR L	1992→	OE083	RA6HC	0.7	8809	SRO-5U	
	XR R	→1984	OE083	RA6HC	0.8	8809	SRO-5U	
	XR R / RE / RN / RP / RS (ME06)	1984→1995	OE073	RA4HC	0.7		SRO-5U	
	XR R / RT / RV (MD30)	1996→		RGU94C	0.8	8698	SRO-5U	
	350cc	CB F		OE083	RA6HC	0.7	8809	
CB G (CB350)		1981→1985	OE073	RA4HC	0.6			
CB G, S			OE108	RN3C	0.6	8904		
CB K4		1981→1984		QC57C	0.6			
CB K4 Top Speed (CB350)		1981→1984	OE108	RN3C	0.6	8904		
CL K, SL			OE108	RN3C	0.6	8904		
XL R, K (ND03)		1985→1987	OE083	RA6HC	0.9	8809	SRO-5U	
XLX			OE083	RA6HC	0.9	8809	SRO-5U	
XR R			OE083	RA6HC	0.9	8809	SRO-5U	
360cc		CB K, G (CB360)	1980→1985	OE108	RN3C	0.7	8904	
	CJ T (CJ360)	1980→1984	OE108	RN3C	0.6	8904		
400cc	CB / CB-1 (CB400N)	1978→1984	OE083	RA6HC	0.7	8809	SRO-5U	
	CB A	1979→	OE083	RA6HC	0.8	8809		
	CB F, LC (CB400F)	1980→1984	OE073	RA4HC	0.6			
	CB N (CB400N)	1980→1984	OE083	RA6HC	0.7	8809		
	CB T (NC27)	1991→		RGU94C	0.9	8698		
	CBR Gull Arm J (NC23)			RGU94C	0.9	8698		
	CBR RR J	1990→		RGU94C	0.9	8698		
	CBR Tri Arm J (NC29)			RGU94C	0.9	8698		
	CBX F / F2 / SS			OE073	RA4HC	0.7		
	CMT (NC01)	1980→1984	OE083	RA6HC	0.7	8809		
	CX C, F2		OE083	RA6HC	0.7	8809		
	CX -Euro		OE108	RN3C	0.6	8904		
	FL R		OE108	RN3C	0.6	8904		
	GL, C		OE083	RA6HC	0.7	8809		
	Hawk (I)		OE083	RA6HC	0.8	8809		
	N R		OE073	RA4HC	0.6			
	NS / NS R (NC19)	1985→	OE108	RN3C	0.6	8904		
	NV		OE083	RA6HC	0.9	8809		
	NV		OE073	RA4HC	0.6			
	VF F	1985→	OE083	RA6HC	0.9	8809		
	VFR J (NC21)			RGU94C	0.9	8698		
	VFR J (NC24)			RGU94C	0.9	8698		
	VFR R (NC24)			RGU94C	0.7	8698		
	XL	1984→	OE083	RA6HC	0.7	8809		
	XL (CB400N)	1978→1983	OE073	RA4HC	0.6			
	XR R	1996→	OE083	RA6HC	0.7	8809		
	450cc	CB M (PC14)	1985→	OE083	RA6HC	0.7	8809	
CB N			OE073	RA4HC	0.9		PRO-5M	
CB S (PC17)		1986→1989	OE083	RA6HC	0.7	8809		
CM A,C, E (PC17)		1986→1989	OE073	RA4HC	0.6			
CMX C			OE083	RA6HC	0.9	8809		
CR R			OE091	RN2C	0.6	8904		
CRF R 4T		2002→	OE094	RC6YCC	1.1			
CRS R2 / R3		2002→		QC59YC	1.1			
480cc	CR R		OE078	N3G	0.6	8904		

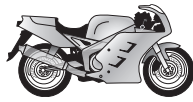
**21****POWER SPORT****...HONDA****500cc**

CB (K1)	→1975	OE112	A6GC	0.6	8809	
CB	1984→	OE083	RA6HC	0.6	8809	
CB (K3)	→1975		P-RA7HC	0.6	8812	
CB			QN86	0.6		
CB / CB S (PC32)	1996→		RGU94C	0.9	8698	
CB F	2004→		RGU94C	0.9	8698	
CB F, Super Sport (PC26)	1994→		RGU94C	0.9	8698	
CB R		OE108	RN3C	0.5	8904	
CB T, K2 (PC32)	1996→		RGU94C	0.9	8698	
CB V (PC26)	1994→	OE092	RG4HC	0.9	8698	
CBR F		OE083	RA6HC	0.9	8809	
CBR FS A	1995→	OE083	RA6HC	0.9	8809	
CBR S (PC15)	1988→	OE073	RA4HC	0.9		
CBX			RAX92C	0.7	8809	
CR, Moto-Cross		OE108	RN3C	0.5	8904	
CX (PC03)	1983→	OE083	RA6HC	0.7	8809	
CX C		OE083	RA6HC	0.7	8809	
CX E	1979→1984	OE083	RA6HC	0.7	8809	
CX Turbo (PC06)	1979→1984	OE083	RA6HC	0.7	8809	
FT (PC07)	1982→1985	OE083	RA6HC	0.7	8809	
GB (PC16)	1992→	OE083	RA6HC	0.9	8809	SRO-5U
GB (PC16)	1988→1992	OE073	RA4HC	0.9		SRO-5U
GL (PC02)	1979→1984	OE083	RA6HC	0.7	8809	
Magna V30	1987→	OE083	RA6HC	0.9	8809	
NX		OE083	RA6HC	0.9	8809	
SL (PC07)	1982→1986	OE073	RA4HC	0.6		
VF F (PC12)	1984→	OE083	RA6HC	0.9	8809	
VF F2 (PC12)	1985→		RAX92YC	0.7	8809	
VF F2 (PC12)	→1984	OE083	RA6HC	0.9	8809	
VT C (PC8)	1983→	OE083	RA6HC	0.9	8809	
VT E (PC11)	1983→1985	OE083	RA6HC	0.9	8809	
XBR (PC15)	1988→	OE083	RA6HC	0.9	8809	
XBR S (PC15)	1985→1987	OE083	RA6HC	0.9	8809	
XL (I) (PD02)	1983→	OE083	RA6HC	0.7	8809	
XL R		OE083	RA6HC	0.7	8809	
XL S (PD01)	1979→1981	OE083	RA6HC	0.7	8809	
XR	1980→	OE083	RA6HC	0.7	8809	
XR R	1980→	OE083	RA6HC	0.9	8809	

550cc

CB, F (CB550)	1971→1987		P-RA7HC	0.7	8812	
CB F1, F2	1976→		P-RA7HC	0.6	8812	SRO-5U
CB K3, 4	1976→		P-RA7HC	0.6	8812	SRO-5U
CBX F, F2 (PC04)	1982→1985	OE083	RA6HC	0.7	8809	

600cc

CB F FA Hornet	2007→		RGU94C	0.9	8698	
CB F Hornet (ED)	2004→		RGU94C	0.9	8698	
CB F W Hornet (PC34)	1998→		RGU94C	0.9	8698	
CB Hornet (ED)	2004→		RGU94C	0.9	8698	
CBR F (PC35)	2001→			0.9	8698	
CBR F (PC25)	1991→1993		RGU94C	0.9	8698	
CBR F (PC19)	1987→1988	OE083	RA6HC	0.9	8809	
CBR F (PC23)	1989→1990		RAX92YC	0.9	8809	
CBR F Sport (PC31)	1995→		RGU94C	0.9	8698	
CBR F2 (PC25)	1993→1994		RGU94C	0.9	8698	
CBR F3 (PC31)	1995→1998		RGU94C	0.9	8698	
CBR FS (PC35)	2001→2002			0.9	8698	

**HONDA**

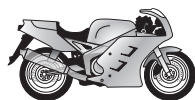
**21****POWER SPORT****...HONDA**

...600cc						
CBR FX (PC35)	1999 → 2001	RGU94C	0.9	8698		
CBR RR (PC37) (G)	2003 → 2004		0.9	8698		
CBR RR (PC40)	2007 →		0.9	8698		
CBR RR (PC37)	2005 → 2006		0.9	8698		
CBR RR Movistar	2006 →		0.9	8698		
CBX E	→ 1988	OE073 RA4HC	0.9			
CBX R	1983 → 1987	OE083 RA6HC	0.9	8809		
CBX R	1989 →	RA2HC	0.9			
FJS	2001 →	RGU94C	0.9	8698		
NTV (PC21)		OE083 RA6HC	0.9	8809		SRO-5U
NV		OE083 RA6HC	0.9	8809		
NX		OE083 RA6HC	0.9	8809		
V Transalp (PDO6)	1987 →	OE083 RA6HC	0.9	8809		
VT C, Shadow (PC21)	1988 →	OE083 RA6HC	0.9	8809		
VT C, Shadow (PC21)	1995 →	OE083 RA6HC	0.9	8809		
VT D Shadow (PC21)	1993 →	OE083 RA6HC	0.9	8809		
XL L, LM (PDO4)	1986 →	OE083 RA6HC	0.9	8809		SRO-5U
XL R (PDO6)	1987 →	OE083 RA6HC	0.9	8809		SRO-5U
XL RM (PDO4)	1983 → 1987	OE083 RA6HC	0.8	8809		SRO-5U
XL V, VN Transalp (PDO3)	1983 → 1987	OE083 RA6HC	0.9	8809		SRO-5U
XLV, N Transalp (PDO6)	1994 →	OE083 RA6HC	0.9	8809		SRO-5U
XR R, L	1987 →	OE083 RA6HC	0.9	8809		SRO-5U
XR RR, S, T, V		OE083 RA6HC	0.9	8809		SRO-5U
XV		OE083 RA6HC	0.9	8809		
650cc						
CB C (RC03)	1980 →	OE083 RA6HC	0.8	8809		
CB C, Z (RC05)	1980 → 1984	OE083 RA6HC	0.8	8809		
CB S, SC, SCF, Dominator (RC17)		RA2HC	0.9			
CB SC (RC08)	1980 →	OE083 RA6HC	0.9	8809		
CBX E (RC17)		RA2HC	0.9			
CBX FD		RAX92YC	0.8	8809		
CBX Nighthawk I (RC13)	1983 →	RAX92YC	0.8	8809		
CX C (RC13)	1983 →	OE083 RA6HC	0.9	8809		
CX E (RC11)	1983 →	OE083 RA6HC	0.9	8809		
CX Turbo (RC16)	1983 → 1987	OE132 A6HC	0.6	8809		
FMX	2005 →	OE083 RA6HC	0.9	8809		SRO-5U
FX Vigor	1998 →	OE083 RA6HC	0.9	8809		
GL, DX (RC10)	1983 →	OE083 RA6HC	0.9	8809		
NT		OE083 RA6HC	0.9	8809		
NTV (RC33)	1996 →	OE083 RA6HC	0.9	8809		
NTV Deauville (RC33)	1988 → 1991	OE083 RA6HC	0.9	8809		
NTV Revere (RC33)	1988 →	OE083 RA6HC	0.9	8809		
NTV S (RC47)	1998 →	OE083 RA6HC	0.9	8809		
NTV T (RC33)	1995 →	OE083 RA6HC	0.9	8809		
NX Dominator (RD02)	1988 → 1995	OE083 RA6HC	0.9	8809		SRO-5U
NX Dominator (RD08)	1996 →	OE083 RA6HC	0.9	8809		SRO-5U
SLR (Air cooled) (RD09)	1996 →	OE083 RA6HC	0.9	8809		
XL L / Transalp	1994 →	OE083 RA6HC	0.9	8809		SRO-5U
XR L, RL	1993 →	OE083 RA6HC	0.9	8809		
XR R (R1)	2000 →	QC59YC	1.1			
XRV Africa Twin (RD03)	1988 →	OE083 RA6HC	0.8	8809		
680cc						
Deauville	2005 → 2006	OE083 RA6HC	0.9	8809		
Deauville	2007 →	RG6YC	0.9			

**HONDA**

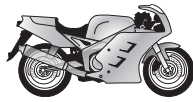
**21****POWER SPORT****...HONDA**

Capacity	Model	Year	Part No.	Thread	Gap (mm)	Part No.	Notes
700cc	CB SC		OE073	RA4HC	0.6		
	VF C,F,S		OE083	RA6HC	0.9	8809	
	VFR F			RAX92YC	0.9	8809	
	VT C Chopper	1987→		P-RA7HC	0.9	8812	
750cc	CB (RC04)	1982→1983	OE083	RA6HC	0.7	8809	SRO-5U
	CB (RC42)	1992→	OE083	RA6HC	0.9	8809	SRO-5U
	CB		OE083	RA6HC	0.7	8809	SRO-5U
	CB C (RC42)	1992→	OE083	RA6HC	0.8	8809	SRO-5U
	CB F (RC04)	→1991	OE083	RA6HC	0.7	8809	SRO-5U
	CB F (RC42)	1992→	OE083	RA6HC	0.9	8809	SRO-5U
	CB F2 (RC06)	1980→	OE083	RA6HC	0.7	8809	SRO-5U
	CB F2 (RC42)	1995→	OE083	RA6HC	0.9	8809	SRO-5U
	CB F2 N, FI	→1991	OE083	RA6HC	0.7	8809	SRO-5U
	CB FA I	1991→	OE083	RA6HC	0.8	8809	SRO-5U
	CB FOUR I		OE083	RA6HC	0.7	8809	SRO-5U
	CB FZ		OE083	RA6HC	0.7	8809	SRO-5U
	CB K (CB750)	1981→1984	OE083	RA6HC	0.7	8809	SRO-5U
	CB KZ (RC01)	1982→1983	OE083	RA6HC	0.7	8809	SRO-5U
	CBR		OE073	RA4HC	0.6		
	CBX F, K (RC17)	1984→1986	OE083	RA6HC	0.9	8809	
	CBX F2 (RC17)	1983→1987		RAX92YC	0.7	8809	
	NR (RC40)	1993→	OE092	RG4HC	0.9	8698	SRO-5U
	NV	→1987	OE083	RA6HC	0.9	8809	
	NV	1987→	OE083	RA6HC	0.9	8809	
	RVF (RC45)	1994→	OE092	RG4HC	0.9	8698	SRO-5U
	Shadow	2004→	OE083	RA6HC	0.9	8809	
	VF C (RC09)	1982→1985	OE083	RA6HC	0.9	8809	SRO-5U
	VF C Chopper	1994→		RGU94C	0.9	8698	SRO-5U
	VF C Chopper (RC09)	1986→		RAX92YC	0.7	8809	SRO-5U
	VF C Magna Chopper (RC43)	1994→		RGU94C	0.9	8698	
	VF F Chopper (RC15)	1983→1984	OE083	RA6HC	0.9	8809	
	VF S Chopper (RC07)	1982→1983	OE083	RA6HC	0.9	8809	SRO-5U
	VFR F (RC30)	1988→	OE092	RG4HC	0.9	8698	
	VFR F (RC36)	1994→	OE092	RG4HC	0.9	8698	
	VFR F (RC36)	1990→1994		RGU94C	0.9	8698	
	VFR FJ I (RC24)	1986→1987	OE083	RA6HC	0.9	8809	
	VFR R (RC36)			RAX92YC	0.7	8809	
	VT C Shadow Spirit (RC53A)	2006→		P-RA7HC	0.9	8812	
	VT C, S (V2) (RC44)	1997→	OE083	RA6HC	0.9	8809	
	VT C2 Shadow Ace (RC29)	1987→	OE083	RA6HC	0.9	8809	
XLV R (RD01)	1983→	OE083	RA6HC	0.9	8809		
XRV Africa Twin (RD04)	1990→1992	OE083	RA6HC	0.9	8809		
XRV Africa Twin (RD07)	1993→	OE083	RA6HC	0.9	8809		
800cc	PC	1994→		P-RA7HC	0.9	8812	SRO-5U
	VFR / VFR ABS	2002→				8654	
	VFR FI W		OE092	RG4HC	0.9	8698	
	VT Chopper	1994→		P-RA7HC	0.9	8812	
900cc	CB F, F2 (SC01)	1979→1983	OE083	RA6HC	0.7	8809	SRO-5U
	CB F, FZ, C, F2 (SC01)	1980→1984	OE083	RA6HC	0.6	8809	SRO-5U
	CBR RR Fireblade (SC44)	2000→2001	OE092	RG4HC	0.9	8698	
	CBR RR Fireblade (SC28)	1991→1995	OE092	RG4HC	0.9	8698	
	CBR RR Fireblade (SC33)	1996→1999	OE092	RG4HC	0.9	8698	
	CBR RR Fireblade (SC50)	2002→2004			0.9	8698	
	Hornet	2002→		RGU94C	0.9	8698	

**HONDA**

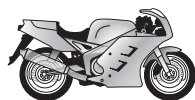
**21****POWER SPORT****...HONDA**

Capacity	Model	Year	Part No.	mm	Part No.	Notes	
1000cc	CB C, F	1997 →	RAX92YC	0.8	8809		
	CB F (SC30)	1993 →	RAX92YC	0.8	8809	SRO-5U	
	CB F		OE083 RA6HC	0.8	8809	SRO-5U	
	CBR F (SC21)	1987 →1988	RAX92YC	0.8	8809	SRO-5U	
	CBR F (SC24)	1989 →1992	RAX92YC	0.8	8809	SRO-5U	
	CBR F		RAX92YC	0.8	8809	SRO-5U	
	CBR K1 (SC24)	1992 →	RAX92YC	0.9	8809		
	CBR RR Fireblade	2004 →2007		0.9	8698		
	CBR RR Fireblade	2008 →		0.9	8698		
	GL Goldwing K1, K2, KZ (GL1)	1980 →1987	OE083 RA6HC	0.7	8809		
	Varadero XLV (SD02)	2003 →	OE083 RA6HC	0.9	8809		
	Varadero XLV X (SD01)	1999 →2002	OE083 RA6HC	0.9	8809		
	VF Bol D' Dor (SC15)	1983 →1986	RAX92YC	0.7	8809	SRO-5U	
	VF F (SC15)	→1986	RAX92YC	0.8	8809	SRO-5U	
	VF F (SC15)	1985 →	RAX92YC	0.7	8809	SRO-5U	
	VF F2 (SC16)	1984 →1986	OE083 RA6HC	0.9	8809	SRO-5U	
	VF R (SC15)	1987 →	OE083 RA6HC	0.9	8809	SRO-5U	
	VTR (SC36)	1997 →1999	RAX92YC	0.7	8809		
	VTR SP1	2000 →2001	QC59YC	1.1			
VTR SP2	2002 →	QC59YC	1.1				
1050cc	CBX (CB1)	1980 →1987	OE083 RA6HC	0.9	8809		
1100cc	CB F, FD (SC11)	1980 →1986	OE083 RA6HC	0.8	8809	SRO-5U	
	CBR (SC08)	1982 →1985	OE083 RA6HC	0.9	8809		
	CBR (SC05)	1980 →1987	OE083 RA6HC	0.6	8809		
	CBR XX (SC35) Super Blackbird	1997 →2000	OE092 RG4HC	0.9	8698		
	CBR XX Super Blackbird	2001 →2001		0.9	8698		
	CBR XX Super Blackbird	2002 →		0.9	8698		
	CBX-11 SF-Y	1999 →	RGU94C		8698		
	GL, DX (SC02)	1982 →1987	OE083 RA6HC	0.9	8809		
	GL, DX (SC08)		OE083 RA6HC	0.7	8809		
	GL D, DX (SC02)	→1981	OE083 RA6HC	0.7	8809		
	GL DX (SC02)	→1981	OE083 RA6HC	0.7	8809		
	GL F (SC02)	1982 →1987	OE083 RA6HC	0.9	8809		
	GL R (SC11)		OE083 RA6HC	0.7	8809		
	ST (SC26)	1992 →	RGU94C	0.9	8698		
	ST AN Pan Europa (SC26)	1990 →	RGU94C	0.9	8698		
	ST CBS-ABS-TCS Pan Europa	1996 →	RGU94C	0.9	8698		
	VF C (SC12)	1983 →1987	OE083 RA6HC	0.9	8809		
	VT, C Chopper (SC23)	1994 →	OE083 RA6HC	0.9	8809		
	VT, C Chopper (SC23)	1988 →1993	P-RA7HC	0.9	8812		
	VT C2 Shadow (SC23)	1995 →	P-RA7HC	0.9	8812		
	X-11	2000 →	RGU94C	0.9	8698		
	1200cc	GL (SC16)	1983 →1987	OE083 RA6HC	0.9	8809	
		GLA (SC14)	1984 →1987	OE083 RA6HC	0.9	8809	
1300cc	CB	1998 →	OE083 RA6HC	0.9	8809		
	CB S	2005 →	OE083 RA6HC	0.9	8809		
	CBR X4 1300 Big One	1997 →	RAX92YC	0.8	8809		
	Pan European	2002 →	RGU94C	0.9	8698		
	VTX / VTX S	2002 →	RA8HC		8812		
	X 4	1997 →	OE083 RA6HC	0.9	8809		

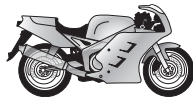
**21****POWER SPORT****...HONDA**

1500cc	F6 Custom (SC34)	1997→		P-RA7HC	0.9	8812
	GL (SC22)	1989→1993		P-RA7HC	0.9	8812
	GL A/SE	1994→1994		P-RA7HC	0.9	8812
	GL C (SC34)	1997→		P-RA7HC	0.9	8812
	GL Gold Wing	1995→		P-RA7HC	0.9	8812
	GL SE.A Gold Wing	1995→		P-RA7HC	0.9	8812
	VTX (Twinspark)	2003→	OE039	RC9YC4	1.1	
1800cc	GL Gold Wing	2001→	OE039	RC9YC4	1.1	
	VTX	2001→	OE039	RC9YC4	1.1	

HOREX

400cc	Regina	1953→1956	OE108	RN3C		8904
--------------	--------	-----------	--------------	------	--	------

HRD

50cc	GS Enduro	1998→	OE108	RN3C		8904
	Slide Sonic Supermotard	1998→	OE108	RN3C		8904
	Sonic 2 SM	1999→	OE108	RN3C		8904
	Sonic 2 Trail	1999→	OE108	RN3C		8904

125cc	125	1999→		RG96C	0.7	8698
	Cabriolet Supermotard	1999→	OE092	RG4HC		8698
	Cabriolet Trail	1999→	OE092	RG4HC		8698

HUSABERG

350cc	MC , Cross, Enduro, FE, FC, Elduro			RG94C	0.7	8698
400cc	FC			G59C		8698
	FC470	2000→	OE083	RA6HC		8809
	FE e	2000→2002	OE083	RA6HC		8809
	FS c	2000→2002	OE083	RA6HC		8809
	FS e	2000→2002	OE083	RA6HC		8809
	FX E			G59C		8698
450cc	450	2003→	OE083	RA6HC		8809
	FE e	2000→	OE083	RA6HC		8809
470cc	FC470	2000→	OE083	RA6HC		8809
	FX470e	2000→	OE083	RA6HC		8809
499cc	FC MX	1995→1999		G59C		8698
500cc	FE	1991→1999		G59C		8698
	FE e	2000→	OE083	RA6HC		8809
	MC 501	→1999		G59C		8698
501cc	501	2003→	OE083	RA6HC		8809
	FC	1995→1999		G59C		8698
	FE	1993→1999		G59C		8698
	FE e	1993→1999		G59C		8698
	FX	1997→1999		G59C		8698
550cc	550	2003→	OE083	RA6HC		8809
	FC	2000→	OE083	RA6HC		8809
	FE e	2000→	OE083	RA6HC		8809
	FS e	2000→	OE083	RA6HC		8809
600cc	FC	1992→1999		G59C		8698
	FE	1992→1999		G59C		8698
	FES E	1998→1999		G59C		8698
	FX	1997→1999		G59C		8698
	FX E	1997→1999		G59C		8698
	MC	→1999		G59C		8698

**HUSABERG**

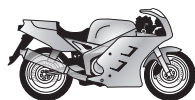
**21****POWER SPORT****...HUSABERG**

650cc	650	2003 →	OE083	RA6HC		8809	
	FE e	2000 →	OE083	RA6HC		8809	
	FS c	2000 →	OE083	RA6HC		8809	
	FS c	2000 →	OE083	RA6HC		8809	
	FS e	2000 →	OE083	RA6HC		8809	
	FS e	2000 →	OE083	RA6HC		8809	
	FX e	2000 →	OE083	RA6HC		8809	

HUSQVARNA

50cc	Husky Boy	1998 →		L78C	0.5	8883	
	Husky Boy Junior / Senior / Racing	1998 →		L82C	0.6	8814	
	SM	2002 →	OE091	RN2C	0.5	8904	
	WRE	2002 →	OE091	RN2C	0.5	8904	
	WRS Husky H20		OE040	N2C	0.7	8904	
125cc	Air cooled		OE091	RN2C	0.5	8904	
	CR	1999 →	OE091	RN2C	0.5	8904	
	CR	1990 → 1998	OE040	N2C	0.5	8904	
	Motocross			QN84	0.5		
	NWR	1999 →		QN84	0.5		
	SM / S	1999 →	OE091	RN2C	0.5	8904	
	TC		OE091	RN2C	0.5	8904	
	WER	1999 →	OE091	RN2C	0.5	8904	
	WR	2001 →	OE091	RN2C	0.5	8904	
	WR	1993 → 2000	OE125	N2G	0.5	8904	
	WR	1990 → 1992		QN84	0.5		
	WRE	1998 →	OE125	N2G	0.5	8904	
	WRK			QN84	0.5		
240cc	CR			QN84	0.5		
	RC			QN84	0.5		
	WR			QN84	0.5		
	WRE			QN84	0.5		
	WRK			QN84	0.5		
250cc	Air cooled		OE091	RN2C	0.5	8904	
	CR	2001 →	OE108	RN3C	0.5	8904	PRO-5M
	CR	1990 → 2000	OE125	N2G	0.5	8904	PRO-5M
	Motocross			QN84	0.5		
	TC	2001 →		RG94C	0.6	8698	
	TE / R	2001 →		RG94C	0.6	8698	
	WR	1999 →	OE078	N3G	0.5	8904	PRO-5M
	WR	1992 → 1998	OE125	N2G	0.5	8904	PRO-5M
	WRK			QN84	0.5		
260cc	WR		OE125	N2G	0.5	8904	
350cc	TE ,WXC	1990 →		G59C	0.5	8698	
360cc	CR	1991 →	OE078	N3G	0.5	8904	
	Cross			QN84	0.5		
	WR	1991 →	OE078	N3G	0.5	8904	
	WXC	1998 →	OE078	N3G	0.5	8904	
390cc	Air cooled		OE091	RN2C	0.5	8904	
	MX		OE040	N2C	0.5	8904	
400cc	MX		OE040	N2C	0.5	8904	
	SM / R 400 R	2001 →		RG94C	0.6	8698	
	TE	2001 →		G59C	0.5	8698	
	TE R	2000 →		RG94C	0.6	8698	
	WR			QN86	0.5		
410cc	TE	1995 →		G59C	0.6	8698	SRO-5U

HUSABERG

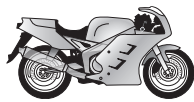
**21****POWER SPORT****...HUSQVARNA**

420cc	Air cooled		OE091	RN2C	0.5	8904	
430cc	Air cooled		OE091	RN2C	0.5	8904	
	CR		OE040	N2C	0.5	8904	SRO-5U
450cc	Air cooled		OE091	RN2C	0.5	8904	
	SM R	2003 →		RG94C	0.6	8698	
	TC	2001 →		RG94C	0.6	8698	
	TE	2003 →		RG94C	0.6	8698	
500cc	Air cooled		OE091	RN2C	0.5	8904	SRO-5U
	TC (Air cooled)		OE083	RA6HC	0.7	8809	SRO-5U
	TE (Air cooled)		OE083	RA6HC	0.7	8809	SRO-5U
	TX (Air cooled)		OE083	RA6HC	0.7	8809	
510cc	AC		OE083	RA6HC	0.9	8809	SRO-5U
	Huski	1987 →		RG96C	0.7	8698	
	SM R			RG94C	0.6	8698	
	TC	1991 →		RG94C	0.6	8698	SRO-5U
	TC	1987 → 1990		G59C	0.6	8698	SRO-5U
	TC	1987 →		RG96C	0.7	8698	SRO-5U
	TC 500 (Air cooled)		OE083	RA6HC	0.7	8809	SRO-5U
	TE	→ 1990	OE083	RA6HC	0.9	8809	SRO-5U
	TE	2003 →		RG94C	0.6	8698	SRO-5U
	TE	1991 → 2002	OE083	RA6HC	0.7	8809	SRO-5U
	TX (Air cooled)		OE083	RA6HC	0.7	8809	
570cc	SM R	2001 →		RG96C	0.7	8698	SRO-5U
	SM R NOX	1999 →		G54V			SRO-5U
	TC	2000 →		RG96C	0.7	8698	SRO-5U
	TE	2000 →		RG96C	0.7	8698	SRO-5U
577cc	LT 610			G59C	0.5	8698	
	SM 610			G59C	0.5	8698	
	TC 610			G59C	0.5	8698	
	TE 610 E			G59C	0.5	8698	
	TEE 610 Enduro			G59C	0.5	8698	
580cc	TE 610 ,Cross TC,WXC			G59C	0.5	8698	
610cc	SM R	1999 →		RG94C	0.7	8698	
	SM S	1999 →		RG96C	0.7	8698	
	TC			G59C	0.6	8698	SRO-5U
	TE Cross TC, WXC	1991 →		RG96C	0.7	8698	SRO-5U
	TE E	1999 →		RG96C	0.7	8698	SRO-5U
630cc	SM R	2004 →		G54V			

HYOSUNG

110cc	FX (Air cooled)			Z9Y	0.7		
	Midas DLX (Air cooled)	1999 →		Z9Y	0.7		PRO-5U
125cc	Aquila GV (Air/Oil cooled)	2000 →		RG94C		8698	
	Cruise I (Air/Oil cooled)		OE083	RA6HC		8809	
	Cruise II (Air/Oil cooled)	2000 →		RGU94C	0.9	8698	
	GA III (Air cooled)	2000 →		RGU94C	0.9	8698	
	GF (Air cooled)	1999 →		RGU94C	0.9	8698	
	GS	1997 →	OE083	RA6HC	0.8	8809	
	GT / R	2005 →		RGU94C	0.9	8698	
	Hyper GPS	1998 →	OE083	RA6HC	0.8	8809	
	Karion	2002 →		RGU94C	0.9	8698	
	Naked	2001 →		RG94C	0.6	8698	
	RX Off Road (Air/Oil cooled)	2000 →		RGU94C		8698	
	XRX	1999 →		RGU94C	0.8	8698	

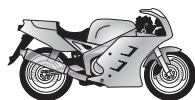
**21****POWER SPORT****...HYOSUNG**

250cc	Aquila V2 (Air/Oil cooled)	2000 →	RG94C		8698
	GT	2005 →	RG94C		8698
	GV		RG94C		8698
650cc	GT / R / S	2005 →	RG94C		8698
	GV	2006 →	RG94C		8698
	Naked	2004 →	RG94C		8698

ILO ROCKWELL

48cc	F48 JLO		OE037 L86C	0.5	
50cc	G JLO		OE037 L86C	0.5	
	V49 50 JLO		OE037 L86C	0.5	

IMPULS

50cc	HK50Q, HK50Q-4A, LX50T Mini Bike		OE059 L92YC	0.8	
-------------	----------------------------------	--	--------------------	-----	--

INDIAN

50cc	JC, JX, CX, MT		L82C	0.6	8814
	M, MM		OE037 L86C	0.6	
	MX50R		OE040 N2C	0.6	8904
	XC50R		L82C	0.6	8814
70cc	SE, ME, SR, MX, CX		L78C	0.6	8883
75cc	CX-75, M-74, MX-76		L78C	0.6	8883
80cc	MX-80, CX-80R		OE068 N3C	0.6	8904
100cc	ML-, MT-, ME-, MS-100		J4C	0.6	
125cc	ME-, MCL-, MT-125		OE068 N3C	0.6	8904
	MI-, MS-, SS-125		OE068 N3C	0.6	8904
175cc	MI-, MS-, MT-, ME-175		OE068 N3C	0.6	8904
200cc	MI-, MS-, MT-200		OE068 N3C	0.6	8904
1442cc	All Models	1999 → 2003	OE042 RN12YC	1.0	8405
1640cc	Chief	2002 → 2008	OE042 RN12YC	1.0	8405
1720cc	Chief	2009 →	OE042 RN12YC	1.0	8405
	Boy Racer, Papoose Mini Bike		RL86C	0.8	
	Ponybike Mini Bike		RL86C	0.8	

INTRAMOTOR GLORIA

50cc	Blanco		OE037 L86C	0.5	
	Scout		RN5C	0.5	8339

IRONHEART MOTOR CO.

1340cc		1995 → 1998	OE042 RN12YC	1.0	8405
---------------	--	-------------	---------------------	-----	------

ITALJET

50cc	50 Corvo Cross		OE086 RL82C	0.5	8814
	JC5 A		OE037 L86C	0.5	
	JC5 B		OE037 L86C	0.5	
	JC5 C		OE037 L86C	0.5	
	JT5 A		OE037 L86C	0.5	
	Junior C		OE086 RL82C	0.5	8814
	Junior C4M		OE086 RL82C	0.5	8814
	Mini Bambino		OE037 L86C	0.5	
	MT5 A		OE037 L86C	0.5	
	Pack 2		OE037 L86C	0.5	
	Pack 3		OE037 L86C	0.5	
	Piranha		OE037 L86C	0.5	
	Pop Corn		RN5C	0.5	8339
	Pulse		OE037 L86C	0.5	
	T (12,7mm/1/2in.)		QN84	0.5	
	T (19mm/3/4in.)		OE086 RL82C	0.5	8814
	Teenager Scimitar		OE086 RL82C	0.5	8814

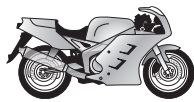
**21****POWER
SPORT****...ITALJET**

...50cc	Tiffany		OE037	L86C	0.5	
	Winner		OE037	L86C	0.5	
	X R		OE086	RL82C	0.5	8814
80cc	T100 (12,7mm/1/2in.)		OE086	RL82C	0.5	8814
	T100 (19mm/3/4in.)			QN84	0.5	
100cc	Ranger		OE037	L86C	0.5	
125cc	Buccaneer		OE108	RN3C	0.5	8904
	Coyote		OE086	RL82C	0.5	8814
	Kangaroo		OE108	RN3C	0.5	8904
	Kit-Kat (12,7mm/1/2in.)		OE086	RL82C	0.5	8814
	Kit-Kat (19mm/3/4in.)			RN5C	0.5	8339
	Super			L82C	0.5	8814
250cc	Trial		OE015	N12YC	0.8	8405
350cc	Boss		OE083	RA6HC	0.6	8809
	Casual		OE098	RN4C	0.5	8339
	Rambo		OE098	RN4C	0.5	8339
	Road Master		OE098	RN4C	0.5	8339
	Scott		OE083	RA6HC	0.6	8809
	Trial		OE015	N12YC	0.6	8405

IZH

346cc	Jupiter		OE007	L87YC	0.7	
347cc	7.107		OE038	L82YC	0.7	8814
	6.113.6.114		OE007	L87YC	0.7	
	6.113-01		OE007	L87YC	0.7	
	Planeta		OE038	L82YC	0.7	8814

JAWA/ CZ

48cc	Korado Lux (Air cooled)	1995 → 1998		L82C		8814
49cc	05		OE037	L86C	0.5	
	20		OE037	L86C	0.5	
	208B Babetta		OE037	L86C	0.5	
	Jawetta		OE037	L86C	0.5	
	Jawetta 550		OE037	L86C	0.5	
	Jawetta 555		OE037	L86C	0.5	
	Manet		OE037	L86C	0.5	
50cc	210		OE037	L86C	0.5	
	215		OE037	L86C	0.5	
	Babetta 207			L90C	0.6	
	Babetta 210		OE037	L86C	0.5	
	Betcar	2006 →		Z9Y	0.6	
	Moped			L78C	0.5	8883
	Mustang 23		OE037	L86C	0.5	
	Mustang Erica		OE037	L86C	0.5	
	Scooter			L78C	0.5	8883
	Sport 21		OE037	L86C	0.5	
	90cc	Babetta			L78C	0.5
Cezeta				L78C	0.5	8883
Cross Roadster				L78C	0.5	8883
Robot				L78C	0.5	8883
Trail				L78C	0.5	8883

**JAWA/ CZ**

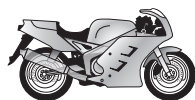
**21****POWER
SPORT****...JAWA/ CZ**

125cc	488		OE037	L86C	0.6	
	CZ			L78C	0.5	8883
	Dakar	2003 →	OE083	RA6HC	0.7	8809
	Dandy			RAX92C	0.8	8809
	Grand Prix			QL55	0.5	
	Moto-Cross			QL55	0.5	
	Roadster			L82C	0.5	8814
	Sport	2003 →	OE083	RA6HC	0.7	8809
	175cc	487		OE037	L86C	0.6
CZ				L78C	0.5	8883
Enduro		1977 →	OE037	L86C	0.5	
Sport				L82C	0.5	8814
Trail				L82C	0.5	8814
250cc	485		OE037	L86C	0.6	
	Calif III			L78C	0.5	8883
	Custom Spts. Roadst		OE037	L86C	0.5	
	CZ			L78C	0.5	8883
	Deluxe		OE037	L86C	0.5	
	Enduro			L78C	0.5	8883
	Grand Prix			QL55	0.5	
	I.S.D.T.	1977 →		QL55	0.5	
	Moto-Cross			QL55	0.5	
	MX	1977 →		QL55	0.5	
350cc	472		OE037	L86C	0.6	
	634 Series			L78C	0.5	8883
	638 Series			L78C	0.5	8883
	639 Series			L78C	0.5	8883
	640 Series			L78C	0.5	8883
	Black Style 640	1993 →		L78C	0.5	8883
	Calif III			L78C	0.5	8883
	Calif IV			L78C	0.5	8883
	Chopper			L78C	0.5	8883
	CZ			L78C	0.5	8883
	De-Luxe			L78C	0.5	8883
	Gespann	1987 →	OE037	L86C	0.6	
	I.S.D.T.	1977 →		QL55	0.5	
	Javelin			L78C	0.5	8883
	Javelin Super			L78C	0.5	8883
	Sabater			L78C	0.5	8883
	Shadow Sport			L78C	0.5	8883
	Style			L78C	0.5	8883
	Super Sport			L78C	0.5	8883
	Tradesman			L78C	0.5	8883
	TS			L78C	0.5	8883
	Twin Sport			L78C	0.5	8883
	Velorex			L78C	0.5	8883
360cc	GS			L77JC4	0.7	8883
	Moto-Cross			QL55	0.5	
400cc	Grand Prix			QL55	0.5	
	Moto-Cross			QL55	0.5	
500cc	871-5 Speedway			G57R	0.5	
	872-5 Speedway			G57R	0.5	
	884 Speedway			G57R	0.5	
	888 Speedway			G57R	0.5	

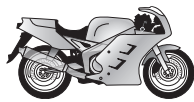
**21****POWER
SPORT****...JAWA/ CZ**

...500cc	890 Iceracing (Pushrod)		C55R	0.5		
	890 Longtrack (Pushrod)		C55R	0.5		
	890 Longtrack		C55R	0.5		
	890 Speedway (Pushrod)		C55R	0.5		
	891 Iceracing		C55R	0.5		
	892 Iceracing (Pushrod)		C55R	0.5		
	892 Longtrack (Pushrod)		C55R	0.5		
	892 Speedway (Pushrod)		C55R	0.5		
	893 Iceracing		C55R	0.5		
	893-7 Iceracing		C55R	0.5		
	894 Speedway		C55R	0.5		
	895 Longtrack		C55R	0.5		
	895 Speedway		C55R	0.5		
	896 Longtrack		G55R	0.5		
	897 Speedway		G57R	0.5		
	898 Speedway		G57R	0.5		
	DT Speedway		OE040 N2C	0.5	8904	
	R		OE112 A6GC	0.5	8809	
650cc	Classic	2004 →	OE083 RA6HC	0.7	8809	
	Dakar	2006 →	OE083 RA6HC	0.7	8809	
	Style	2004 →	OE083 RA6HC	0.7	8809	

JCM

125cc	Trial		OE001 N9YC	0.7	8415	
240cc	Trial		OE010 N7YC	0.7	8332	
333cc	Trial		OE010 N7YC	0.7	8332	

JINCHENG

50cc	JC50Q (Honda Chaly)		Z9Y			
	JC50Q-7 (Honda Monkey)		Z9Y			
	TR36 (Angel)(Honda Chaly)		Z9Y			

100cc	JC100-7 (Cruiser)		Z9Y			
--------------	-------------------	--	-----	--	--	--

125cc	JC125A		OE083 RA6HC		8809	
--------------	--------	--	--------------------	--	-------------	--

JLO

50cc	Other models		OE037 L86C	0.5		
	RM170		OE037 L86C	0.5		

KAWASAKI

50cc	AE		OE108 RN3C	0.6	8904	PRO-5M
	AR		OE108 RN3C	0.6	8904	PRO-5M
	AV	→1983	OE083 RA6HC	0.8	8809	PRO-5M
	AV	1984 →	P-RZ9HC	0.6		PRO-5M
	KH		OE098 RN4C	0.6	8339	PRO-5M
	KMX	1993 →	OE108 RN3C	0.6	8904	PRO-5M
	KS I		OE108 RN3C	0.6	8904	PRO-5M
	KSR I		OE108 RN3C	0.6	8904	PRO-5M
60cc	KX		OE091 RN2C	0.6	8904	PRO-5M
65cc	KX	2000 →	QN84	0.6		PRO-5M
75cc	KV	1976 →1980	OE086 RL82C	0.6	8814	
	MB1	1969 →1971	RJ8C	0.8		
	MT1	1971 →1980	OE086 RL82C	0.6	8814	
80cc	AE	→1982	OE008 RN7YCC	0.8	8332	PRO-5M
	AE	1983 →	OE108 RN3C	0.6	8904	PRO-5M
	AN		Z9Y	0.7		PRO-5M
	AR	→1982	OE087 N6YC	0.6	8902	PRO-5M
	DX		OE108 RN3C	0.6	8904	PRO-5M

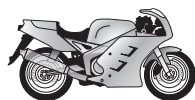
**21****POWER SPORT****...KAWASAKI**

Capacity	Model	Year	Part No.	Thread	Gap (mm)	Part No.	Part No.
...80cc	KD		OE079	N4C	0.7	8339	PRO-5M
	KH		OE079	N4C	0.8	8339	PRO-5M
	KMX (KSR2)	1993 →	OE091	RN2C	0.6	8904	PRO-5M
	KSR II		OE108	RN3C	0.6	8904	
	KX	1981 → 1982	OE040	N2C	0.6	8904	PRO-5M
	KX	→ 1980	OE068	N3C	0.8	8904	PRO-5M
	KX	1983 → 1991	OE125	N2G	0.6	8904	PRO-5M
	KX	1992 →		QC57	0.6		PRO-5M
85cc	KX	2000 →		QC57	0.6		PRO-5M
90cc	AX1			Z9Y	0.6		
	G3SS A, B		OE086	RL82C	0.6	8814	
	G3SS C, D			L78C	0.6	8883	
	GAT A		OE086	RL82C	0.6	8814	
	GA2 A		OE086	RL82C	0.6	8814	
	KC / A		OE068	N3C	0.6	8904	PRO-5M
	KC C / D			L78C	0.6	8883	PRO-5M
	KE		OE068	N3C	0.6	8904	PRO-5M
	KE (12.7mm/1/2in.)			L82C	0.6	8814	PRO-5M
	KH		OE068	N3C	0.6	8904	PRO-5M
	KM		OE086	RL82C	0.6	8814	PRO-5M
100cc	AGI	→ 1986		L82C	0.6	8814	
	AGI	1987 →	OE108	RN3C	0.6	8904	
	GTO110	1987 →	OE108	RN3C	0.6	8904	
	KC		OE108	RN3C	0.6	8904	PRO-5M
	KD	→ 1986		L82C	0.6	8814	PRO-5U
	KE (12.7mm/1/2in.)			L78C	0.6	8883	PRO-5M
	KE (19.0mm/3/4in.)		OE108	RN3C	0.6	8904	PRO-5M
	KH ELX, EX, ESX		OE108	RN3C	0.6	8904	PRO-5M
	KM	→ 1986	OE086	RL82C	0.6	8814	PRO-5U
	KV		OE108	RN3C	0.6	8904	PRO-5U
	KX	1992 →		QC57	0.6		
	110cc	KAZE	1995 →		Z9Y	0.6	
KH			OE108	RN3C	0.6	8904	
KZE		1995 →		Z9Y	0.6		
Mojave				Z9Y	0.6		
125cc	AR GTO		OE108	RN3C	0.6	8904	PRO-5M
	DX		OE091	RN2C	0.6	8904	PRO-5M
	Eliminator BN (Air cooled)	1998 → 2000		RG94C	0.7	8698	
	Eliminator BN	2001 →		RG96C	0.7	8698	
	KC		OE037	L86C	0.8		PRO-5M
	KD			L78C	0.6	8883	PRO-5U
	KDX SR		OE108	RN3C	0.6	8904	PRO-5M
	KE	1985 →	OE091	RN2C	0.6	8904	PRO-5U
	KE (12.7mm/1/2in.)			L78C	0.6	8883	PRO-5U
	KE (19.0mm/3/4in.)		OE108	RN3C	0.6	8904	PRO-5U
	KH A, B, K		OE091	RN2C	0.6	8904	PRO-5M
	KH ES, EX		OE108	RN3C	0.6	8904	PRO-5M
	KMX (Liquid cooled)	2002 →		QN84	0.6		PRO-5M
	KS A			L78C	0.6	8883	PRO-5U
	KX	2004 → 2005	OE098	RN4C	0.7	8339	
	KX	1982 → 1990	OE040	N2C	0.6	8904	PRO-5M
KX	2000 → 2003	OE091	RN2C	0.8	8904		
KX	1990 → 1999		QC57	0.6			
KX (KX125K4)	1997 → 2000	OE091	RN2C	0.6	8904		

KAWASAKI

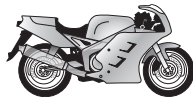
**21****POWER
SPORT****...KAWASAKI**

140cc	AR A		OE108	RN3C	0.6	8904	
160cc	LT A		OE073	RA4HC	0.6		
175cc	AGI		OE098	RN4C	0.6	8339	
	KD			L77JC4	0.7	8883	PRO-5M
	KDX		OE091	RN2C	0.6	8904	PRO-5M
	KE	→1980		L77JC4	0.7	8883	PRO-5M
	KE	1981→	OE079	N4C	0.8	8339	PRO-5M
	KE B			L77JC4	0.7	8883	PRO-5M
	KE D		OE079	N4C	0.8	8339	PRO-5M
	KV		OE098	RN4C	0.6	8339	
	KX		OE091	RN2C	0.6	8904	PRO-5M
200cc	KMX (MX200A)	1988→	OE108	RN3C	0.8	8904	PRO-5M
	KZ		OE098	RN4C	0.6	8339	
	Z (KZ200A)		OE098	RN4C	0.6	8339	PRO-5M
250cc	AGI		OE108	RN3C	0.6	8904	
	BJ Estrella A (Fast Riding) (BJ250C)	1993→1996		RAX92C	0.6	8809	
	BJ Estrella C (BJ250C)	1997→		RAX92C	0.6	8809	
	BR		OE073	RA4HC	0.6		
	EL E,F Eliminator LX, SE	1989→		RZ94C	0.6		
	ER A, B, C		OE073	RA4HC	0.6		
	EX E, F, H (EX250)			RZ94C	0.6		
	F11 Series			L78C	0.6	8883	
	GPX R			RZ94C	0.6		
	GPZ Belt Drive		OE083	RA6HC	0.9	8809	
	GPZ R			RZ94C	0.6		
	KE		OE108	RN3C	0.6	8904	PRO-5U
	KH	1973→1979		L78C	0.6	8883	PRO-5U
	KL A3-5		OE108	RN3C	0.6	8904	PRO-5M
	KLE		OE073	RA4HC	0.6		
	KLR (KL250D)			RAX92YC	0.6	8809	
	KLT		OE108	RN3C	0.6	8904	
	KLX (KL250B)	1980→1984	OE098	RN4C	0.6	8339	PRO-5U
	KLX (KLX250E)	1993→		RG94C	0.6	8698	
	KR 1R / 1S		OE091	RN2C	0.6	8904	PRO-5M
	KSF Mojave		OE083	RA6HC	0.8	8809	
	KT			L82C	0.7	8814	PRO-5U
	KV AI		OE108	RN3C	0.6	8904	
	KX	1997→2002	OE078	N3G	0.6	8904	
	KX	2003→	OE078	N3G	0.6	8904	
	KX	→1991	OE125	N2G	0.8	8904	PRO-5M
	KX	1992→1996		QN84	0.6		
	KX F 4 stroke	2004→		RG94C	0.6	8698	
	KX R	2005→		QN86	0.6		
	KX T Tecate Prairie		OE108	RN3C	0.6	8904	
	KZ A, B, J	→1982	OE098	RN4C	0.6	8339	
	KZ C		OE108	RN3C	0.6	8904	
	KZ C, G, L, M		OE108	RN3C	0.6	8904	
	KZ D	1983→	OE098	RN4C	0.6	8339	PRO-5M
KZ G		OE073	RA4HC	0.6		PRO-5M	
LTD Belt Drive		OE083	RA6HC	0.6	8809		
LX		OE108	RN3C	0.6	8904	PRO-5M	
S1 Mach I, A, B, C			L77JC4	1.0	8883		
S1 Mach I, A, B, C Top Speed			L78C	0.6	8883		
XT A		OE108	RN3C	0.6	8904		

**KAWASAKI**

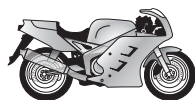
**21****POWER SPORT****...KAWASAKI**

Capacity	Model	Year	Part No.	Thread	Gap (mm)	Part No.	Notes
...250cc	Z A FS		OE108	RN3C	0.6	8904	
	Z A, B, E, J, Scorpion		OE083	RA6HC	0.6	8809	
	Z Belt Drive		OE073	RA4HC	0.6		
	Z C, D, G LTD		OE098	RN4C	0.6	8339	PRO-5M
	Z T			RAX92YC	0.9	8809	
	ZR	1993 →	OE092	RG4HC	0.8	8698	
	ZX	1993 →	OE092	RG4HC	0.6	8698	
300cc	KAF A/B Mule	1992 → 1996	OE045	RN11YCC	0.8	8405	PRO-5M
	KLX R	1996 →	OE083	RA6HC	0.7	8809	
305cc	EX 305 A, B		OE073	RA4HC	0.6		
	GPZ Belt Drive	1983 →		RAX92YC	0.9	8809	
	LTD A		OE073	RA4HC	0.6		
	Z305		OE083	RA6HC	0.8	8809	
350cc	S2 Mach II			L77JC4	1.0	8883	
	S2A Mach II			L77JC4	1.0	8883	
400cc	EN A		OE083	RA6HC	0.7	8809	
	FX R			RA2HC	0.6		
	GPX R J			RAX92C	0.7	8809	
	GPZ F, FI			RAX92YC	0.9	8809	
	GPZ R J			RAX92C	0.7	8809	
	KH			L78C	0.6	8883	PRO-5U
	KLE	1993 →	OE083	RA6HC	0.7	8809	
	KLF -B2, -B3 Bayou	1994 →	OE083	RA6HC	0.8	8809	
	KX A		OE091	RN2C	0.6	8904	
	KZ B, C, D, G, H		OE098	RN4C	0.6	8339	
	KZ E, J, K (,KZ500M)	1983 →	OE083	RA6HC	0.6	8809	
	KZ E, J, K (,KZ500M)	→ 1982	OE073	RA4HC	0.6		
	LTD		OE083	RA6HC	0.7	8809	
	S3			L77JC4	1.0	8883	
	S3 A			L77JC4	1.0	8883	
	Z		OE073	RA4HC	0.6		PRO-5M
	Z A,B,C,D,G,H		OE083	RA6HC	0.7	8809	PRO-5M
	Z F		OE098	RN4C	0.6	8339	
	Z F- II		OE098	RN4C	0.6	8339	
	Z FX, Z		OE098	RN4C	0.6	8339	
	Z J		OE073	RA4HC	0.6		
	Z J I			P-RA7HC	0.6	8812	
	Z K		OE083	RA6HC	0.7	8809	
	Z LTD		OE083	RA6HC	0.8	8809	PRO-5M
	Z LTD II		OE073	RA4HC	0.6		PRO-5M
	Z M			RAX92YC	0.8	8809	
	Z R	1983 →	OE083	RA6HC	0.6	8809	
	ZL Eliminator SE	1993 →	OE083	RA6HC	0.7	8809	
	ZR	1993 →		RAX92YC	0.9	8809	
	ZR	1984 →	OE083	RA6HC	0.8	8809	
	ZR -B1, -C1	1993 →	OE092	RG4HC	0.8	8698	
	ZR -C Xanthus	→ 1983		P-RA7HC	0.7	8812	
ZR -C Zephyr			RAX92YC	0.9	8809		
ZRX		OE092	RG4HC	0.8	8698		
ZX -L1, -L2		OE092	RG4HC	0.7	8698		
ZX Z400-F2	1993 →	OE092	RG4HC	0.8	8698		
ZX ZXR400 R, ZZR400	1993 →		RAX92YC	0.9	8809		
ZX4 J		OE092	RG4HC	0.7	8698		
ZXR Supersport (Liquid cooled) (ZX400L)		OE092	RG4HC	0.8	8698		

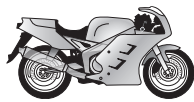
**21****POWER SPORT****...KAWASAKI**

420cc	DX		OE108	RN3C	0.6	8904	
	KX A		OE091	RN2C	0.6	8904	
440cc	Z A, C, D, H (KZ440)		OE098	RN4C	0.6	8339	PRO-5M
	Z LTD (KZ440)		OE108	RN3C	0.6	8904	
450cc	DX		OE108	RN3C	0.6	8904	
	EN A I		OE083	RA6HC	0.6	8809	
	KX		OE091	RN2C	0.6	8904	
	LTD Belt Drive (Liquid cooled) (EN450A,B)	1985 →	OE083	RA6HC	0.8	8809	
500cc	EN B +A (EN500A)	1996 →		RAX92C	0.7	8809	
	EN B A (EN500C)	1990 →		RAX92C	0.8	8809	
	EN C (EN500A)	1996 →	OE083	RA6HC	0.7	8809	
	EN Vulcan +A (EN500)		OE083	RA6HC	0.7	8809	
	EN Vulcan A (EN500)			RAX92C	0.7	8809	
	ER A, B +A (ER500A/B)	1996 →		RAX92C	0.7	8809	
	ER A, B A (ER500A/B)	1996 →	OE083	RA6HC	0.7	8809	
	ER-5 (Liquid cooled)	1997 →		RAX92C	0.7	8809	
	EX GPZ500 S EN 500	1993 →	OE083	RA6HC	0.7	8809	
	GPX	1989 →		RAX92C	0.7	8809	
	GPZ R	1994 →		RAX92C	0.7	8809	
	GPZ S EX 500C, F +A	1996 →	OE083	RA6HC	0.7	8809	
	GPZ S EX 500C, F A	1996 →		RAX92C	0.7	8809	
	GPZ S EX 500D			RAX92C	0.7	8809	
	GPZ S EX 500D7 (Liquid cooled)		OE083	RA6HC	0.7	8809	
	GPZ S EX500-E9		OE083	RA6HC	0.7	8809	
	GRZ S (EX500E)	1986 →		RAX92C	0.7	8809	
	H1 B			UL81C	0.6	8814	
	H1 D, E, F			L77JC4	1.0	8883	
	H1 Mach III, H1 A			L77JC4	1.0	8883	
	KH			L77JC4	1.0	8883	PRO-5U
	KH Top Speed			L77JC4	1.0	8883	PRO-5U
	KL A, B (LE500)		OE073	RA4HC	0.6		
	KLE	1990 →2004		RAX92C	0.8	8809	
	KLE	2005 →		RAX92C	0.8	8809	
	KLR		OE083	RA6HC	0.9	8809	
	KX B, C, D, E	1993 →	OE108	RN3C	0.6	8904	
	KZ A, B			RA2HC	0.6		
	LE A			RAX92C	0.8	8809	
	Z (KZ500B)		OE083	RA6HC	0.7	8809	
	Z B1, B2		OE083	RA6HC	0.7	8809	
	ZL		OE083	RA6HC	0.7	8809	
	ZR		OE083	RA6HC	0.7	8809	
	ZX A, B			RA2HC	0.6		
	ZZR (ZX500)		OE092	RG4HC	0.7	8698	
550cc	GPZ			RAX92YC	0.9	8809	
	GPZ Unitrack I		OE083	RA6HC	0.7	8809	
	GT (KZ550G)	1983 →	OE083	RA6HC	0.8	8809	
	KZ A, B, C, D, F, G, H		OE073	RA4HC	0.6		
	LTD	1980 →1985	OE083	RA6HC	0.7	8809	
	Z A, B, C, D, E, F, FX, G, GT, GP, LTD		OE083	RA6HC	0.8	8809	
	Zephyr (ZR550B8)	1991 →		RAX92C	0.7	8809	
	Zephyr Classic (ZR550B)	1997 →		RAX92C	0.7	8809	
	ZR A			RA2HC	0.6		
	ZX A1			RAX92YC	0.9	8809	

**KAWASAKI**

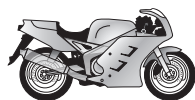
**21****POWER SPORT****...KAWASAKI**

600cc				mm	POWER SPORT	
GPX (ZX600C)	1996 →		RAX92C	0.7	8809	
GPX R Sportler (ZX600C)	1988 →1994	OE083	RA6HC	0.7	8809	
GPZ			RAX92C	0.9	8809	
GPZ R	→1991		RAX92C	0.9	8809	
GPZ R		OE083	RA6HC	0.7	8809	
GPZ R I	1992 →	OE083	RA6HC	0.8	8809	
KL		OE083	RA6HC	0.9	8809	
KL R-AI I		OE083	RA6HC	0.7	8809	
KLR			RAX92YC	0.9	8809	
KLR	1985 →	OE083	RA6HC	0.9	8809	
KLR EL I	→1984	OE083	RA6HC	0.7	8809	
KLR S		OE083	RA6HC	0.9	8809	
Ninja R (ZX600B)			RA2HC	0.6		
XT		OE083	RA6HC	0.9	8809	
ZL (ZL600A,B)	1986 →	OE083	RA6HC	0.7	8809	
ZL Eliminator (ZL6008)	1995 →	OE083	RA6HC	0.7	8809	
ZL Eliminator Chopper +A (ZL6008)	1995 →		RAX92C	0.7	8809	
ZL Eliminator Chopper A (ZL600R)	1995 →		RAX92C	0.7	8809	
ZX		OE083	RA6HC	0.7	8809	
ZX A I			RAX92C	0.7	8809	
ZX-6R Ninja	1995 →	OE092	RG4HC	0.8	8698	
ZX-6RR Ninja	2004 →	OE092	RG4HC	0.8	8698	
ZZR (Liquid cooled) (ZX600E9)	1990 →	OE092	RG4HC	0.8	8698	
ZZR (ZX600E)	1993 →	OE092	RG4HC	0.8	8698	
636cc						
ZX-6R Ninja	2003 →	OE092	RG4HC	0.8	8698	
ZX-6RR Ninja	2003 →	OE092	RG4HC	0.8	8698	
650cc						
ER-6f	2006 →	OE122	RG4PHP	0.9	8698	
ER-6n	2006 →	OE122	RG4PHP	0.9	8698	
KL	1993 →	OE083	RA6HC	0.9	8809	
KLR (Liquid cooled)	1986 →1994	OE083	RA6HC	0.8	8809	
KLR (Liquid cooled)	1993 →	OE083	RA6HC	0.9	8809	
KLR Tengai (Liquid cooled) (KL650C)	1995 →	OE083	RA6HC	0.9	8809	
KLX (KLX650A)	1993 →	OE083	RA6HC	0.9	8809	SRO-5U
KLX (KLX650C1)	1995 →	OE083	RA6HC	0.9	8809	SRO-5U
KLX R (KLX650C)	1993 →	OE083	RA6HC	0.9	8809	SRO-5U
KZ (2650B/C)	1978 →	OE098	RN4C	0.6	8339	
Tengai	→1993	OE073	RA4HC	0.9		
Versys	2006 →	OE122	RG4PHP	0.9	8698	
W Retro (Air cooled) (EJ650C1)	1999 →		RG94C	0.8	8698	
Z D, CSR, F2, F3, B (KZ650F)		OE098	RN4C	0.6	8339	PRO-5M
700cc						
LTD		OE108	RN3C	0.6	8904	
Vulcan		OE083	RA6HC	0.6	8809	
Z		OE108	RN3C	0.6	8904	
ZN A		OE108	RN3C	0.6	8904	
750cc						
GP R (ZX750G)		OE073	RA4HC	0.6		
GPX R	1987 →	OE083	RA6HC	0.7	8809	SRO-5U
GPZ	1985 →	OE083	RA6HC	0.7	8809	PRO-5M
GPZ R		OE091	RN2C	0.6	8904	SRO-5U
GPZ Turbo		OE091	RN2C	0.6	8904	SRO-5U
GT (KZ750P)	1982 →1987	OE108	RN3C	0.6	8904	
H2 Mach IV, A, B, C			L77JC4	1.0	8883	PRO-5M
KZ		OE083	RA6HC	0.9	8809	
LTD		OE108	RN3C	0.6	8904	PRO-5M
Ninja		OE073	RA4HC	0.9		

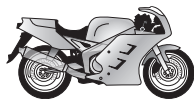
**21****POWER
SPORT****...KAWASAKI****...750cc**

VN (VN750A)	1986 →		P-RA7HC	0.9	8812	
VN Vulcan (VN750A1,-A5)			P-RA7HC	0.9	8812	
VZ		OE073	RA4HC	0.9		
Z	2004 →			0.7	8654	
Z (GT750)	1993 →	OE083	RA6HC	0.7	8809	PRO-5M
Z		OE091	RN2C	0.6	8904	PRO-5M
Z, L		OE098	RN4C	0.6	8339	PRO-5M
Z A, B, D, E, H, L, K, P, R, 2		OE108	RN3C	0.6	8904	PRO-5M
Z GP, GT, L3, LTD (ZX750E)		OE091	RN2C	0.6	8904	PRO-5M
Z KI		OE098	RN4C	0.6	8339	PRO-5M
Z LTD Belt Drive		OE004	RN9YCC	0.8	8415	PRO-5M
Z LTD Twin		OE004	RN9YCC	0.8	8415	PRO-5M
Z M			RN5C	0.6	8339	PRO-5M
Z S Twin		OE108	RN3C	0.6	8904	PRO-5M
Z Turbo		OE108	RN3C	0.6	8904	PRO-5M
ZL A		OE083	RA6HC	0.7	8809	
ZR C Zephyr	1991 →2000	OE083	RA6HC	0.7	8809	
ZR S	2005 →	OE092	RG4HC	0.7	8698	
ZR Zephyr D1/D2	1996 →2000		RAX92C	0.7	8809	
ZR-7	1999 →		RAX92C	0.9	8809	
ZR-7S (Air cooled)	1999 →		RAX92C	0.7	8809	
ZRX		OE073	RA4HC	0.6		
ZX J (10mm plug)		OE092	RG4HC	0.8	8698	
ZX J (12mm)		OE073	RA4HC	0.8		
ZX N1, P1	1996 →	OE092	RG4HC	0.8	8698	
ZX-7R Ninja (Liquid cooled) (ZX750N,P)	1996 →	OE092	RG4HC	0.7	8698	
ZX-7RR Ninja (ZX750N,P)	1996 →	OE092	RG4HC	0.7	8698	
ZXR (ZX750J)	1988 →1993	OE092	RG4HC	0.7	8698	
ZXR (ZX750L)	1990 →	OE092	RG4HC	0.7	8698	
ZXR R (ZX750 J/L/M)	1993 →	OE092	RG4HC	0.8	8698	
ZXR R	1988 →1993	OE092	RG4HC	0.8	8698	

800cc

VN Chopper (VN800B1/B2)	1996 →	OE092	RG4HC	0.8	8698	
VN Chopper (VN800A)	1995 →		RG96C	0.8	8698	
VN Chopper Vulcan "Classic" (Liquid cooled) (V Twin)	1999 →		RG96C	0.7	8698	
VN Chopper Vulcan "Classic"	1997 →		RG96C	0.7	8698	
VN Drifter (Liquid cooled) (V Twin)	1995 →		RG96C	0.8	8698	

900cc

GPZ R, Eliminator	1990 →	OE083	RA6HC	0.7	8809	
GPZ R, Eliminator I	1990 →		RAX92C	0.6	8809	
R 16V			RA2HC	0.6		
VN / Classic	2006 →		RG6YC	0.9		
Z (Z1,Z1F)		OE108	RN3C	0.6	8904	
Z Z1A - Z1B (Z1,Z1F)		OE108	RN3C	0.6	8904	
ZL A (Z900)		OE083	RA6HC	0.7	8809	
ZX A (ZX900A)			RAX92C	0.7	8809	
ZX-9R (Liquid cooled) (ZX900B1/B2)	1994 →1995	OE092	RG4HC	0.7	8698	
ZX-9R Ninja (ZX900B)	1995 →1999	OE092	RG4HC	0.7	8698	
ZX-9R Ninja	2000 →	OE092	RG4HC	0.7	8698	

1000cc

A R1		OE108	RN3C	0.6	8904	
GPZ (ZX100E1)	1995 →		RAX92C	0.8	8809	
GPZ AZ		OE108	RN3C	0.6	8904	
GPZ R I (ZX1000A)	1986 →	OE083	RA6HC	0.8	8809	
GPZ RX			RAX92C	0.8	8809	
GTR (ZGT1000A)	1994 →		RAX92C	0.7	8809	PRO-5M
GTR			RAX92C	0.7	8809	PRO-5M

**KAWASAKI**

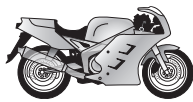
**21****POWER
SPORT****...KAWASAKI****...1000cc**

GTR		OE083	RA6HC	0.7	8809	PRO-5M
GTR I (ZG1000A)	1986 →	OE083	RA6HC	0.7	8809	PRO-5M
KLV	2004 →		RG94C	0.7	8698	
KZ (Z1000)		OE108	RN3C	0.6	8904	PRO-5M
LTD (Z1000)		OE108	RN3C	0.6	8904	PRO-5M
ST		OE108	RN3C	0.6	8904	
Z	2003 →2006	OE092	RG4HC	0.8	8698	
Z ES, H, J, LTD, K, R	→2002	OE108	RN3C	0.6	8904	PRO-5M
Z GTR			RA2HC	0.6		PRO-5M
Z RX			RA2HC	0.6		PRO-5M
Z1R	1988 →	OE108	RN3C	0.6	8904	PRO-5M
Z1R II	1988 →	OE108	RN3C	0.6	8904	PRO-5M
ZG A (ZGT00A)			RAX92C	0.7	8809	
ZL	1986 →	OE083	RA6HC	0.7	8809	SRO-5U
ZL A (ZX1000B)			RAX92C	0.7	8809	SRO-5U
ZX (ZX1000B)			RAX92C	0.7	8809	SRO-5U
ZX B		OE092	RG4HC	0.8	8698	SRO-5U
ZX10 R Ninja	2004 →	OE122	RG4PHP	0.9	8698	
ZX10 Tomcat (ZX1000B)	1987 →1990	OE092	RG4HC	0.7	8698	

1100cc

GPZ		OE108	RN3C	0.6	8904	
GPZ (ZX1100E1,E1H,F1) / ABS	1995 →	OE092	RG4HC	0.7	8698	
KZ (KZ1100A)		OE108	RN3C	0.6	8904	
LTD (Z1100K)		OE108	RN3C	0.6	8904	
Z A, GP, ST (KZT10A/B)		OE108	RN3C	0.6	8904	
Zephyr Classic	1992 →	OE092	RG4HC	0.8	8698	SRO-5U
ZN		OE108	RN3C	0.6	8904	
ZR B1	1996 →	OE092	RG4HC	0.8	8698	
ZRX (ZRT10C)	1996 →	OE092	RG4HC	0.7	8698	SRO-5U
ZX F1	1996 →	OE092	RG4HC	0.8	8698	
ZX GP		OE108	RN3C	0.6	8904	
ZX-11 Ninja	1993 →	OE092	RG4HC	0.7	8698	
ZZR (Liquid cooled) (ZX1100D9)	1990 →	OE092	RG4HC	0.8	8698	
ZZR (ZX1100C)	1990 →	OE092	RG4HC	0.8	8698	
ZZR (ZX1100D)	1993 →	OE092	RG4HC	0.8	8698	
ZZR (ZX1100D)	1988 →1993		G59C	0.6	8698	

1200cc

ZG I Voyager-X II	1993 →	OE083	RA6HC	0.9	8809	
ZG Voyager		OE073	RA4HC	0.9		
ZRX R (Liquid cooled)	2000 →	OE092	RG4HC	0.7	8698	
ZRX S (Liquid cooled)	2000 →	OE092	RG4HC	0.7	8698	
ZX-12R Ninja (Liquid cooled)	2000 →	OE092	RG4HC	0.7	8698	
ZZR1200	2001 →	OE092	RG4HC		8698	

1300cc

KZ A		OE108	RN3C	0.6	8904	
Z, Voyager (Z1300A1-A3)	1980 →	OE008	RN7YCC	0.8	8332	
Z A1, A3		OE004	RN9YCC	0.8	8415	
ZG (ZG1300A1-5)		OE004	RN9YCC	0.8	8415	
ZN		OE004	RN9YCC	0.8	8415	

1400cc

GTR	2007 →	OE122	RG4PHP	0.9	8698	
ZZR	2006 →	OE122	RG4PHP	0.9	8698	

KAWASAKI

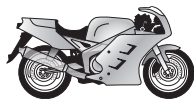
**21****POWER
SPORT****...KAWASAKI**

1500cc	VN A, B VN15, SE, C			P-RA7HC	0.9	8812
	VN Classic Fi (Liquid cooled) (V Twin)	1996 →		RA8HC	0.9	8812
	VN Drifter (Liquid cooled) (V Twin)	1999 →		RA8HC	0.9	8812
	VN Nomad Fi (Liquid cooled) (V Twin)	2000 →		RA8HC	0.9	8812
	VN Sumo	1996 →		P-RA7HC	0.8	8812
	VN1500 Mean Streak	2001 →	OE083	RA6HC		8809
	Vulcan Classic			P-RA7HC	0.9	8812
1600cc	VN (V Twin)	2003 →		RA8HC	0.9	8812
2000cc	VN (V Twin)	2004 →	OE179	RC8WYP4	1.0	

KEEWAY

50cc	CPI Aragon		OE108	RN3C		8904
	F-Act		OE108	RN3C		8904
	Flash		OE108	RN3C		8904
	Hurricane		OE108	RN3C		8904
	Hussar		OE108	RN3C		8904
	Matrix		OE108	RN3C		8904
	Oliver		OE108	RN3C		8904
	Popcorn		OE108	RN3C		8904
125cc	Matrix			RZ96C		
	Speed		OE083	RA6HC		8809
	Superlight		OE083	RA6HC		8809
150cc	Superbike		OE132	A6HC	0.6	8809
250cc	Cruiser			P-RZ9HC		
	Supershadow			P-RZ9HC		

KIEFT

50cc	215		OE037	L86C	0.6	
	K		OE037	L86C	0.6	

KRAMER

250cc	250		OE040	N2C	0.6	8904
--------------	-----	--	--------------	-----	-----	------

KREIDLER

50cc	3L		OE037	L86C	0.4	
	4L		OE037	L86C	0.4	
	5L		OE037	L86C	0.4	
	Florett Series GT, TM		OE086	RL82C	0.4	8814
	J 50 / 51		OE037	L86C	0.6	
	K 50, 51, 52, 52/2, 53 Amazone, Florett Motorrad			L82C	0.6	8814
	K 53/1 Florett Mokick		OE037	L86C	0.6	
	K 54, 54/3, Florett Motorrad / RS			L82C	0.6	8814
	K 54/0 (M) Florett Mokick		OE037	L86C	0.6	
	K 54/2 (A) Florett Super 4			L82C	0.6	8814
	K 54/319 (M) Florett LF		OE037	L86C	0.6	
	K 54/32 D-A (B) Florett LF/LH		OE037	L86C	0.6	
	K 54/404 Florett RMC		OE037	L86C	0.6	
	K 54/410 Florett RMC		OE037	L86C	0.6	
	K 54/421 Florett RMC		OE037	L86C	0.6	
	K 54/5 Florett Super 5/TS			L82C	0.6	8814
	K 54/503 Florett RS L			L82C	0.6	8814
	K 54/511 Florett RS			L82C	0.6	8814
	K 54/512 Mustang / Cross			L82C	0.6	8814
	K 54/52 Florett GT			L82C	0.6	8814
	K 54/53 (B) Florett RS			L82C	0.6	8814
	K 54/54 Florett TM			L82C	0.6	8814
	K 54/540 Florett RMC/S		OE037	L86C	0.6	

**KREIDLER**

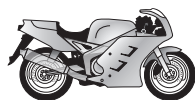
**21****POWER
SPORT****...KREIDLER**

...50cc	K 54/54D Floretti RM		OE037	L86C	0.6		
	LF		OE037	L86C	0.6		
	MF2		OE037	L86C	0.4		
	MF2 CL		OE037	L86C	0.4		
	MG2 C		OE037	L86C	0.4		
	Mofa Mokick Flory 12, Flory 13		OE037	L86C	0.4		
	MP2		OE037	L86C	0.4		
	R			L82C	0.6	8814	
	RS (mot.5-176-223 →)		OE086	RL82C	0.4	8814	
	RS (→ mot.5-176-223)			L77JC4	1.0	8883	
	RS Cockpit (mot.5-176-223 →)		OE086	RL82C	0.4	8814	
	RS Cockpit (→ mot.5-176-223)			L77JC4	1.0	8883	
	RSH (mot.5-176-223 →)		OE086	RL82C	0.4	8814	
	RSH (→ mot.5-176-223)			L77JC4	1.0	8883	

80cc	Enduro		OE086	RL82C	0.4	8814	
	Floret		OE086	RL82C	0.4	8814	

125cc	Enduro	2000 →	OE132	A6HC	0.9	8809	
--------------	--------	--------	--------------	------	-----	------	--

KTM

50cc	ATV 4	1993 →	OE073	RA4HC	0.6		PRO-5M
	Auto Mofa		OE037	L86C	0.6		PRO-5M
	Bora 25	1981 →	OE038	L82YC	0.6	8814	PRO-5M
	Bora 50		OE037	L86C	0.6		PRO-5M
	Cobra Exclusive	1997 →		RL78C		8883	
	Comet	1976 →	OE037	L86C	0.6		PRO-5M
	Cornett		OE037	L86C	0.6		PRO-5M
	Crazy		OE059	L92YC	0.6		PRO-5M
	Foxi		OE037	L86C	0.6		PRO-5M
	GP	1981 →		L82C	0.6	8814	PRO-5M
	GXE		OE125	N2G	0.6	8904	PRO-5M
	GXR		OE125	N2G	0.6	8904	PRO-5M
	Hobby	1981 →	OE001	N9YC	0.6	8415	PRO-5M
	Junior Adventure	2002 →		RL78C	0.6	8883	
	ME	1981 →		L82C	0.6	8814	PRO-5M
	Mini Adventure	2001 → 2001		L78C	0.6	8883	
	Mini Adventure	2002 →		RL78C	0.6	8883	
	Mini Adventure GS	2002 →		RL78C	0.6	8883	
	MLS		OE037	L86C	0.6		PRO-5M
	MMS			L82C	0.6	8814	PRO-5M
	MS		OE037	L86C	0.6		PRO-5M
	Pony	1981 →	OE037	L86C	0.6		PRO-5M
	Postmofa		OE001	N9YC	0.6	8415	PRO-5M
	RSL			L82C	0.6	8814	PRO-5M
	SS-E	1999 →		L78C	0.6	8883	
	SS-GS Pro Junior	1999 →		L78C	0.6	8883	
	SS-GS Pro Senior	1999 →		L78C	0.6	8883	
	Senior	2003 →		QN86	0.6		
	Senior Adventure	2002 →		RL78C	0.6	8883	
	SM		OE038	L82YC	0.6	8814	PRO-5M
	Squadra		OE001	N9YC	0.6	8415	PRO-5M
	SX Junior	2001 → 2001		L78C	0.6	8883	
	SX Junior LC	2002 →		RN57YCC	0.6		
	SX Pro Junior LC	2003 →		QN86	0.6		
	SX Pro Senior LC	2003 →		QN86	0.6		
	SX Senior	2001 → 2001		L78C	0.6	8883	

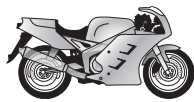
**21****POWER
SPORT****...KTM**

Capacity	Model	Year	Part No.	Thread	Gap	Material	Notes
...50cc	SX Senior LC	2002 →	RN57YCC	0.6			
	SX2	1990 →	OE037 L86C	0.6			PRO-5M
	SX2 Super	1990 →	OE037 L86C	0.6			PRO-5M
	SX3	1990 →	OE037 L86C	0.6			PRO-5M
	SX4	1990 →	OE037 L86C	0.6			PRO-5M
	SXR Adventure	1998 →2001	L78C	0.5	8883		
	SXR Pro Junior	1997 →	OE037 L86C	0.5			
	SXR Pro Senior	1998 →2001	L78C	0.5	8883		
	XR Pro Junior	1998 →2001	L78C	0.5	8883		
	60cc	SX	1998 →	QN84	0.6		
65cc	SX	2001 →2002	RN57YCC	0.6			
	SX	1998 →2000	QN84	0.6			
	SX Beta (19mm)	2003 →2007	QN86	0.6			
	SX KTM (12.7mm)	2008 →	RZ94C	0.6			
80cc	Bora 80	1981 →	L78C	0.6	8883		PRO-5M
	Chopper		L77JC4	0.6	8883		PRO-5M
	Enduro		OE125 N2G	0.6	8904		PRO-5M
	IGS		OE125 N2G	0.6	8904		
	IMX		OE125 N2G	0.6	8904		
	PL	1983 →1984	L78C	0.6	8883		PRO-5M
	RL	1981 →	L78C	0.6	8883		PRO-5M
	RLS	1981 →	L77JC4	0.6	8883		PRO-5M
	RLW	1981 →	L77JC4	0.6	8883		PRO-5M
	RS	1981 →	L78C	0.6	8883		PRO-5M
85cc	IGS		OE125 N2G	0.6	8904		
	IMX		OE125 N2G	0.6	8904		
	SX	2004 →	QN84	0.6			
100cc	GS	1973 →1976	L77JC4	0.6	8883		PRO-5M
	MC	1973 →1976	L77JC4	0.6	8883		PRO-5M
105cc	SX	2004 →	QN84	0.7			
125cc	4T. models		OE083 RA6HC	0.5	8809		
	Auto Mofa		OE037 L86C	0.5			
	Comet		OE037 L86C	0.5			
	EGS	1993 →	OE125 N2G	0.6	8904		
	EGS	1998 →	QN86	0.6			
	EGS	1999 →	QN86	0.6			
	Enduro		OE125 N2G	0.6	8904		PRO-5M
	EXC	2001 →	OE091 RN2C	0.6	8904		
	EXC	1993 →1995	OE125 N2G	0.6	8904		
	EXC	1996 →1997	OE125 N2G	0.6	8904		
	EXC	1997 →1998	QN86	0.6			
	EXC	1998 →1999	QN86	0.6			
	EXC	1999 →2000	QN86	0.6			
	EXE	1999 →	RL78C	0.6	8883		
	GS 12,7 mm		L78C	0.6	8883		PRO-5M
	GS 19,0 mm		OE125 N2G	0.6	8904		PRO-5M
	Hobby		OE037 L86C	0.5			
	III		QN84	0.5			PRO-5M
	LC2	2000 →	RL78C	0.6	8883		
	LC2	1996 →2000	OE091 RN2C	0.6	8904		
	MC 12,7 mm		L78C	0.6	8883		PRO-5M
	MC 19,0 mm		OE125 N2G	0.6	8904		PRO-5M
	MC GP		QL55	0.6			PRO-5M
	MX		OE125 N2G	0.6	8904		

**KTM**

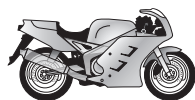

21



POWER
SPORT



...KTM

Capacity	Model	Year	Part No.	Thread	Gap (mm)	Part No.	Part No.
...125cc	Rotax		OE037	L86C	0.5		
	Sting	1998 →	OE108	RN3C	0.7	8904	
	Supermoto	1999 →		RL78C	0.6	8883	
	SX	2002 →	OE091	RN2C	0.6	8904	
	SX	2001 → 2001	OE108	RN3C	0.7	8904	
	SX	1993 → 1995	OE125	N2G	0.6	8904	
	SX	1996 → 1997		RN57YCC	0.6		
	SX	1997 → 1998		QN86	0.6		
	SX	1999 → 2000		QN86	0.6		
	TXC		OE125	N2G	0.6	8904	
175cc	GS			L78C	0.6	8883	PRO-5M
	MC			L78C	0.6	8883	PRO-5M
200cc	EGS	1998 →	OE108	RN3C	0.7	8904	
	EGS	1999 →	OE108	RN3C	0.7	8904	
	EXC	1999 → 2001	OE091	RN2C	0.6	8904	
	EXC	1998 → 1999	OE108	RN3C	0.7	8904	
	EXC	2002 →	OE108	RN3C	0.7	8904	
	MXC	1999 →	OE108	RN3C	0.7	8904	
	SX	2003 →	OE091	RN2C	0.6	8904	
250cc	DXC		OE125	N2G	0.6	8904	
	EGS	1993 → 1995	OE125	N2G	0.6	8904	
	EGS	1997 →		QN86	0.6		
	EGS	1998 →		QN86	0.6		
	EGS	1999 →		QN86	0.6		
	Enduro		OE125	N2G	0.6	8904	
	EXC	1993 → 1995	OE125	N2G	0.6	8904	
	EXC	1996 → 1996	OE125	N2G	0.6	8904	
	EXC	1997 → 1998		QN86	0.6		
	EXC / Sixt Days	1998 → 2001		QN86	0.6		
	EXC Enduro Competition	2003 →	OE098	RN4C	0.6	8339	
	EXC Racing	2002 → 2002		RG94C	0.6	8698	
	EXC Racing	2003 →	OE083	RA6HC	0.6	8809	
	EXC Racing / Sixt Days	2002 → 2002		RG94C	0.6	8698	
	EXC Racing GS	2003 →	OE083	RA6HC	0.6	8809	
	EXC-F	2007 →	OE092	RG4HC	0.7	8698	
	GS 12,7 mm			L77JC4	0.6	8883	PRO-5M
	GS 19,0 mm		OE125	N2G	0.6	8904	PRO-5M
	MC 12,7 mm			L77JC4	0.6	8883	PRO-5M
	MC 19,0 mm		OE125	N2G	0.6	8904	PRO-5M
	MC GP 12,7 mm			L77JC4	0.6	8883	PRO-5M
	MC GP 19,0 mm		OE125	N2G	0.6	8904	PRO-5M
	MX		OE125	N2G	0.6	8904	
	SX	1993 → 1995	OE091	RN2C	0.6	8904	PRO-OU
	SX	1996 →	OE108	RN3C	0.7	8904	PRO-OU
	SX	1997 → 1998		QN86	0.6		PRO-OU
	SX	1998 → 1999		QN86	0.6		PRO-OU
	SX	1999 →		QN86	0.6		PRO-OU
	SX 4 stroke	2005 →	OE092	RG4HC	0.7	8698	
	SXC	1999 →		QN86	0.6		
	SXF	2005 →	OE092	RG4HC	0.7	8698	
	TXC		OE125	N2G	0.6	8904	
273cc	FXC 300			QN84	0.5		
	Sport 300			QN84	0.5		

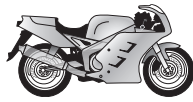
**21****POWER SPORT****...KTM**

Capacity	Model	Year	OE Part	Material	Gap (mm)	Part No.	Notes
300cc	DXC	1990 → 1995	OE125	N2G	0.6	8904	
	EGS	1993 → 1995	OE125	N2G	0.6	8904	
	EGS	1997 →		QN86	0.6		
	EGS	1999 →		QN86	0.6		
	EXC	1993 → 1995	OE125	N2G	0.6	8904	
	EXC	1996 → 1996	OE125	N2G	0.6	8904	
	EXC	1997 → 1998		QN86	0.6		
	EXC / Sixt Days	1999 →		QN86	0.6		
	EXC Enduro Competition	2003 →	OE098	RN4C	0.6	8339	
	GS	1990 → 1995	OE125	N2G	0.6	8904	
	LC (I)		OE091	RN2C	0.6	8904	
	MX	→ 1995	OE125	N2G	0.6	8904	
	MXC	2003 →	OE098	RN4C	0.6	8339	
	MXC	1997 → 2002		QN86	0.6		
	SX	1993 → 1995	OE125	N2G	0.6	8904	
	SX	1999 →		QN86	0.6		
	TXC	→ 1995	OE125	N2G	0.6	8904	
350cc	GS		OE125	N2G	0.6	8904	
	LC4	1993 →	OE083	RA6HC	0.6	8809	PRO-OU
	LC4 EGS, EXC	1993 →	OE083	RA6HC	0.6	8809	PRO-OU
	MX		OE125	N2G	0.6	8904	
360cc	EGS	1997 →		QN86	0.6		PRO-OU
	EXC	1997 →		QN86	0.6		PRO-OU
	MXC	1997 →		QN86	0.6		PRO-OU
	SX	1996 →	OE108	RN3C	0.6	8904	
	SX	1997 →		QN86	0.6		PRO-OU
380cc	380 EXC	1998 →		QN86	0.6		PRO-OU
	EGS	1998 →		QN86	0.6		
	EGS	1999 →		QN86	0.6		
	Enduro	1998 →		QN86	0.6		
	SX	1999 →		QN86	0.6		
390cc	390		OE125	N2G	0.6	8904	
	GS			QN84	0.5		
400cc	EGS	1997 →	OE083	RA6HC	0.6	8809	SRO-5U
	EGS-E	1997 →	OE083	RA6HC	0.6	8809	SRO-5U
	Enduro-E	1998 →	OE083	RA6HC	0.6	8809	SRO-5U
	EXC Racing	1999 → 2002		RG94C	0.7	8698	SRO-5U
	EXC Racing	2002 →	OE083	RA6HC	0.6	8809	SRO-5U
	EXC Racing	2003 →	OE083	RA6HC	0.6	8809	SRO-5U
	GS			L77JC4	0.6	8883	PRO-5M
	LC4	1999 → 2002	OE083	RA6HC	0.7	8809	SRO-5U
	LC4	1998 →	OE083	RA6HC	0.7	8809	SRO-5U
	LC4 Competition	1998 →	OE083	RA6HC	0.7	8809	SRO-5U
	LC4- E Enduro	2001 →	OE083	RA6HC	0.7	8809	SRO-5U
	LC4 EGS	1993 →	OE083	RA6HC	0.6	8809	SRO-5U
	LC4 EXC	1993 →	OE083	RA6HC	0.6	8809	SRO-5U
	LC4-E	1999 → 2002	OE083	RA6HC	0.7	8809	SRO-5U
	LC4-E	2002 →	OE083	RA6HC	0.6	8809	SRO-5U
	LS-E	1997 → 2002	OE083	RA6HC	0.6	8809	SRO-5U
	MC			L77JC4	0.6	8883	PRO-5M
	MC GP			L77JC4	0.6	8883	PRO-5M
	SC	1996 →	OE083	RA6HC	0.6	8809	SRO-5U
	SC	1998 →	OE083	RA6HC	0.6	8809	SRO-5U
Supercompetition	1997 →	OE083	RA6HC	0.6	8809	SRO-5U	

**KTM**

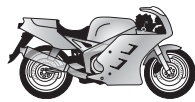
**21****POWER SPORT****...KTM**

...400cc	SX	1998 → 2002	OE083	RA6HC	0.6	8809	SRO-5U
	SX Racing	2002 →	OE083	RA6HC	0.6	8809	
	SX Racing / Six Days	1999 → 2002		RG94C	0.7	8698	
	SXC	1998 → 2002	OE083	RA6HC	0.6	8809	SRO-5U
420cc	420		OE125	N2G	0.6	8904	
	GS XC			QN84	0.5		
440cc	EXC	1994 →	OE125	N2G	0.6	8904	
	SX	1994 →	OE125	N2G	0.6	8904	
450cc	EXC Racing	2003 →	OE083	RA6HC	0.6	8809	
	EXC Racing GS	2003 →	OE083	RA6HC	0.6	8809	
	MXC Dessert	2003 →	OE083	RA6HC	0.6	8809	
	MXC GS	2003 →	OE083	RA6HC	0.6	8809	
	SMR	2005 →	OE083	RA6HC	0.6	8809	
	SX Racing	2003 →	OE083	RA6HC	0.6	8809	
	SX-F	2007 →	OE092	RG4HC	0.7	8698	
477cc	SX-F	2007 →	OE092	RG4HC	0.7	8698	
495cc	495		OE125	N2G	0.6	8904	
	GS XC			QN84	0.6		
	MC			QN84	0.6		
500cc	500 4 TGS			RAX92YC	0.9	8809	
	500 4 TXC			RAX92YC	0.9	8809	
	500 DXC		OE040	N2C	0.6	8904	
	500 EXC		OE040	N2C	0.6	8904	
	500 MX		OE125	N2G	0.6	8904	
	500 SX	1993 →		C57	0.6		
	GS 500 2Stroke		OE040	N2C	0.6	8904	PRO-5M
	GS 500 4Stroke		OE083	RA6HC	0.6	8809	SRO-5U
	MC 500 2Stroke		OE040	N2C	0.6	8904	PRO-5M
	MC 500 4Stroke		OE083	RA6HC	0.6	8809	SRO-5U
510cc	525 XC Desert Racing	2007 → 2007	OE083	RA6HC	0.6	8809	
520cc	520 EXC Racing	2002 →	OE083	RA6HC	0.6	8809	
	520 EXC Racing / Six Days	1999 → 2002		RG94C	0.7	8698	
	520 SX Racing	1999 → 2002		RG94C	0.7	8698	
	520 SX Racing	2002 →	OE083	RA6HC	0.6	8809	
525cc	525 EXC Racing	2003 →	OE083	RA6HC	0.6	8809	
	525 EXC Racing GS	2003 →	OE083	RA6HC	0.6	8809	
	525 MXC	2003 →	OE083	RA6HC	0.6	8809	
	525 MXC Desert Racing	2005 →	OE083	RA6HC	0.6	8809	
	525 SMR	2005 →	OE083	RA6HC	0.6	8809	
	525 SX Racing	2003 →	OE083	RA6HC	0.6	8809	
540cc	540 DXC		OE125	N2G	0.6	8904	
	540 MX		OE040	N2C	0.6	8904	
	540 SXC	1998 →	OE083	RA6HC	0.6	8809	SRO-5U
	540 SXC	1999 →	OE083	RA6HC	0.6	8809	SRO-5U
	540 SXC 20kW	1999 →	OE083	RA6HC	0.6	8809	SRO-5U
	540 SXS Racing	2002 →		RG94C	0.7	8698	
565cc	560 SMR	2007 →	OE083	RA6HC	0.6	8809	
600cc	600 4 TGS			RAX92YC	0.9	8809	
	600 4 TMX			RAX92YC	0.9	8809	
	600 4 TXC			RAX92YC	0.9	8809	
	600 Country		OE083	RA6HC	0.6	8809	
	600 Enduro		OE083	RA6HC	0.6	8809	
	600 MX		OE083	RA6HC	0.6	8809	
	LC4 Enduro 17kW	→ 1987	OE083	RA6HC	0.6	8809	SRO-5U

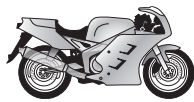
**21****POWER
SPORT****...KTM**

Capacity	Model	Year	Part No.	Material	Gap (mm)	Part No.	Part No.	
...600cc	LC4 Enduro 36kW	→1987	OE083	RA6HC	0.6	8809	SRO-5U	
	LC4 600 EGS	1993→	OE083	RA6HC	0.6	8809	SRO-5U	
	LC4 600 EXC	1993→	OE083	RA6HC	0.6	8809	SRO-5U	
609cc	620 Duke	1994→	OE083	RA6HC	0.6	8809	SRO-5U	
	LC4 620 SC Supermoto	2001→2002	OE083	RA6HC	0.7	8809	SRO-5U	
	LC4 620 Supercompetition	2001→2002	OE083	RA6HC	0.7	8809	SRO-5U	
612cc	LC4 612 EGS	1993→	OE083	RA6HC	0.6	8809	PRO-5M	
	LC4 612 EXC	1993→	OE083	RA6HC	0.6	8809	PRO-5M	
620cc	620 Duke-E	1997→	OE083	RA6HC	0.6	8809	SRO-5U	
	620 EGS	1997→	OE083	RA6HC	0.6	8809	SRO-5U	
	620 EGS-E	1997→	OE083	RA6HC	0.6	8809	SRO-5U	
	620 LS4 Rally	1997→	OE083	RA6HC	0.6	8809	SRO-5U	
	620 LS-E	1997→	OE083	RA6HC	0.6	8809	SRO-5U	
	620 SC	1996→	OE083	RA6HC	0.6	8809	SRO-5U	
	620 SC	1998→	OE083	RA6HC	0.6	8809	SRO-5U	
	620 Supercompetition	1997→2002	OE083	RA6HC	0.6	8809	SRO-5U	
	620 SX	1996→	OE083	RA6HC	0.6	8809	SRO-5U	
	620 SX	1999→	OE083	RA6HC	0.6	8809	SRO-5U	
	LC 4 Supercompetition Supermoto	2002→	OE083	RA6HC	0.6	8809	SRO-5U	
	LC4 620 EGS	1994→	OE083	RA6HC	0.6	8809	SRO-5U	
	LC4 620 EXC	1994→	OE083	RA6HC	0.6	8809	SRO-5U	
	LC4 620 SX	1994→	OE083	RA6HC	0.6	8809	SRO-5U	
	LC4 Super Competition	2000→2002		RAX92YC	0.9	8809	SRO-5U	
	Supermoto Competition 620	1998→2000	OE083	RA6HC	0.6	8809	SRO-5U	
	625cc	625 SC	2002→		RAX92YC	0.9	8809	SRO-5U
		625 SMC	2005→	OE083	RA6HC	0.6	8809	
		625 SXC Hard Enduro	2003→	OE083	RA6HC	0.6	8809	
625 SXC Super Moto		2002→	OE083	RA6HC	0.6	8809	SRO-5U	
640 Duke		2005→	OE083	RA6HC	0.6	8809		
640 Duke 2		2002→2002		RAX92YC	0.9	8809	SRO-5U	
640 LC4		2002→2002		RAX92YC	0.9	8809		
640 LC4		1999→2001	OE083	RA6HC	0.7	8809		
640 LC4 Adventure		2002→2002		RAX92YC	0.9	8809		
640 LC4 SM		2005→	OE083	RA6HC	0.6	8809		
640 LC4 Super Moto		2002→2002		RAX92YC	0.9	8809		
640 LC4-E Six Days		2002→2002		RAX92YC	0.9	8809		
640 LC4-E SM Prestige		2002→2002		RAX92YC	0.9	8809		
640 Supermoto Spezial Edition		2003→	OE083	RA6HC	0.6	8809		
Adventure R 640		1998→2001	OE083	RA6HC	0.7	8809	SRO-5U	
Duke 2		2000→2002	OE083	RA6HC	0.7	8809	SRO-5U	
Duke 640		1998→2001	OE083	RA6HC	0.7	8809	SRO-5U	
Duke II		1999→2001	OE083	RA6HC	0.7	8809	SRO-5U	
Duke II		2002→	OE083	RA6HC	0.6	8809		
LC 4 Adventure R		2002→	OE083	RA6HC	0.6	8809	SRO-5U	
LC 4 E		2002→	OE083	RA6HC	0.6	8809	SRO-5U	
LC 4 E Supermoto		2002→2002	OE083	RA6HC	0.6	8809	SRO-5U	
LC4 Adventure		2000→2000		RAX92YC	0.9	8809	SRO-5U	
LC4 Prestige Supermoto		2003→	OE083	RA6HC	0.6	8809	SRO-5U	
LC4 640		1998→2000	OE083	RA6HC	0.7	8809	SRO-5U	
LC4- 640 Adventure		2001→2002	OE083	RA6HC	0.7	8809	SRO-5U	
LC4 640 Duke II		2003→	OE083	RA6HC	0.6	8809		
LC4- E		2000→2000		RAX92YC	0.9	8809	SRO-5U	
LC4- E 640 Enduro		2001→2001	OE083	RA6HC	0.7	8809	SRO-5U	
LC4- E 640 Supermoto		2001→2001	OE083	RA6HC	0.7	8809	SRO-5U	

**KTM**

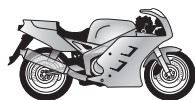
**21****POWER
SPORT****...KTM**

...625cc	LC4- E Supermoto	2000 → 2000		RAX92YC	0.9	8809	SRO-5U
	LC4-640 Hard Enduro	2003 →	OE083	RA6HC	0.6	8809	
640cc	Adventure R LC4	1999 →	OE083	RA6HC		8809	SRO-5U
	E Supermoto LC4	1999 →	OE083	RA6HC		8809	SRO-5U
	Rallye LC4	1998 →	OE083	RA6HC		8809	SRO-5U
650cc	660 LC4 Rallye	1999 → 2001	OE083	RA6HC	0.6	8809	SRO-5U
	660 Rallye	2002 → 2002		RAX92C	0.6	8809	SRO-5U
	660 Super Moto Factory Replica	2002 →		RAX92C	0.6	8809	SRO-5U
	LC4 660	2003 →		RAX92C	0.6	8809	SRO-5U
	Rallye	2000 → 2001		RAX92YC	0.9	8809	SRO-5U
	Rallye	2002 → 2002	OE083	RA6HC	0.6	8809	SRO-5U
654cc	660 SMC	2005 →	OE083	RA6HC	0.6	8809	
	690 LC4 Supermoto / Prestige	2007 →	OE083	RA6HC	0.9	8809	
	Rallye 660	2001 →	OE083	RA6HC	0.8	8809	
950cc	950 Adventure	2003 →		RG94C	0.7	8698	
	950 Adventure S	2003 →		RG94C	0.7	8698	
	950 Super Enduro	2006 →		RG94C	0.7	8698	
	950 Supermoto	2005 →		RG94C	0.7	8698	
	LC8 950 Rally	2003 →		RG94C	0.7	8698	
1000cc	990 Adventure / S	2006 →	OE083	RA6HC	0.6	8809	
	990 Duke	2004 →	OE083	RA6HC	0.6	8809	
	990 Superduke	2005 → 2006	OE083	RA6HC	0.6	8809	
	990 Superduke	2007 →	OE083	RA6HC	0.8	8809	

KUANG YANG

50cc	GS7E - Movie		OE007	L87YC	0.6		
	KA		OE007	L87YC	0.6		
	KA G		OE007	L87YC	0.6		

KYMCO

125cc	Sector (Air cooled)	2000 →	OE083	RA6HC	0.8	8809	
	Stryker (Air cooled)	1999 → 2001	OE083	RA6HC	0.8	8809	
	Stryker II (Air cooled)	2002 →	OE083	RA6HC	0.8	8809	
150cc	B & W Bet & Win	2000 →		P-RA7HC	0.7	8812	
250cc	Venox	2001 →		P-RA7HC	0.9	8812	

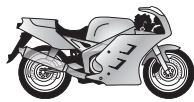
**21****POWER SPORT****LAURA MOTOREN**

50cc	F 38		OE037	L86C	0.5		
	M 48		OE037	L86C	0.5		
	M 54		OE037	L86C	0.5		

LAVALETTE

	All models		OE037	L86C	0.5		
--	------------	--	--------------	------	-----	--	--

LAVERDA

50cc	Adventure		OE098	RN4C	0.5	8339	
	Atlas		OE098	RN4C	0.5	8339	
	Gaucho		OE108	RN3C	0.5	8904	
60cc	Scooter		OE037	L86C	0.5		
125cc	CU Ride		OE091	RN2C	0.5	8904	
	Enduro		OE091	RN2C	0.5	8904	
	Gaucho		OE108	RN3C	0.5	8904	
	GS Lesmo		OE091	RN2C	0.5	8904	
	GSR		OE091	RN2C	0.5	8904	
	LB 1		OE091	RN2C	0.5	8904	
	LB Custom		OE091	RN2C	0.5	8904	
	LB Sport Strada		OE091	RN2C	0.5	8904	
	LZ		OE091	RN2C	0.5	8904	
	Navarro		OE091	RN2C	0.5	8904	
	Regolarità		OE091	RN2C	0.5	8904	
	Toledo		OE108	RN3C	0.5	8904	
	Wild		OE091	RN2C	0.5	8904	
175cc	LZ		OE091	RN2C	0.5	8904	
200cc	Trial		OE108	RN3C	0.5	8904	
250cc	2T		OE091	RN2C	0.6	8904	
	2TR		OE091	RN2C	0.6	8904	
	LH2		OE091	RN2C	0.6	8904	
	Regolarità		OE091	RN2C	0.6	8904	
350cc	Alpino		OE083	RA6HC	0.5	8809	
500cc	Alpino		OE083	RA6HC	0.5	8809	
	Montjuic		OE083	RA6HC	0.5	8809	
600cc	CR Cruiser		OE083	RA6HC	0.6	8809	
	OR Atlas		OE083	RA6HC	0.6	8809	
650cc	Bicilindrico		OE073	RA4HC	0.6		
	Formula	1995 →	OE073	RA4HC	0.6		
	Ghost	1995 →	OE073	RA4HC	0.6		
	Ghost Legend	1995 →	OE073	RA4HC	0.6		
	Ghost Strike	1995 →	OE073	RA4HC	0.6		
	Lynx	2000 →		RG94C	0.8	8698	
	Sport (71)	1995 →	OE073	RA4HC	0.6		
668cc	668			RA59GC	0.7		
	668	1996 →	OE073	RA4HC	0.6		
	650 Ghost		OE073	RA4HC	0.7		
	668 Ghost, Stryke		OE073	RA4HC	0.7		
	Hidalgo		OE073	RA4HC	0.6		
700cc	El Cid		OE073	RA4HC	0.6		
750cc	Diamant	1997 →	OE073	RA4HC	0.9		
	Formula (Liquid cooled)	1997 →	OE073	RA4HC	0.6		
	GS		OE091	RN2C	0.6	8904	
	GT		OE091	RN2C	0.6	8904	
	GTL 770		OE010	N7YC	0.6	8332	
	S Formula (Liquid cooled)	1998 →	OE073	RA4HC			

**LAVERDA**

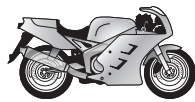
**21****POWER
SPORT****...LAVERDA**

...750cc	S Formula S, Formula, Stryke	1998 →	RA59GC	0.6	
	SF / SF2-10 / SF3		OE091 RN2C	0.6	8904
	SFC		C55R	0.6	
	Sport		C55R	0.6	
	SS		C55R	0.6	
1000cc	3C	→1982	OE108 RN3C	0.6	8904
	3CE	→1982	OE108 RN3C	0.6	8904
	3CL	→1982	OE108 RN3C	0.6	8904
	Jarama		OE108 RN3C	0.6	8904
	Jota	→1982	OE108 RN3C	0.6	8904
	RG		OE091 RN2C	0.5	8904
	RGA		OE091 RN2C	0.5	8904
	RGA Jota		OE091 RN2C	0.5	8904
	RGS		OE091 RN2C	0.5	8904
	SC	→1982	OE108 RN3C	0.6	8904
	SFC		OE091 RN2C	0.5	8904
1200cc	Mirage	→1982	OE108 RN3C	0.6	8904
	TS	1982 →	OE091 RN2C	0.5	8904
	TS	→1982	OE108 RN3C	0.6	8904

LEM

50cc	2001 Bay		OE001 N9YC	0.5	8415
	2001 Matic		OE001 N9YC	0.5	8415
	2001 Variant		OE001 N9YC	0.5	8415
	Champion H-Y		L78C	0.6	8883
	Chembol Form		OE001 N9YC	0.5	8415
	Chembol Raid		OE001 N9YC	0.5	8415
	Cinno Corsa 8 / 10		OE037 L86C	0.5	
	Convert		OE037 L86C	0.5	
	CR 3	1997 →	L82C	0.5	8814
	Cross CR-2		L78C	0.6	8883
	Cross CR-3		OE037 L86C	0.6	
	L 2		L82C	0.5	8814
	LX 1		L78C	0.6	8883
	LX 2	1997 →	L82C	0.5	8814
	LX 2-S Sport	1997 →	L82C	0.5	8814
	LX 2-SR		L82C	0.5	8814
	LX 4 New		OE040 N2C	0.6	8904
	Piesse		OE037 L86C	0.5	
	Pizeta		OE037 L86C	0.5	
	Pratikal Kit SL		OE037 L86C	0.5	
	R 2 Air		OE125 N2G		8904
	R 3 Air		OE125 N2G		8904
	R 3 Usa		OE125 N2G		8904
	Safari BX		L78C	0.6	8883
	Sandy 4M		L78C	0.6	8883
	SK 6		L82C	0.5	8814
	SM 2		L82C	0.5	8814
	SM 3		OE125 N2G		8904
	Small		OE037 L86C	0.6	
	Stratos		OE074 N5C	0.5	8339
	Stratos Matic		OE037 L86C	0.5	

LEOPARD

All models			OE037 L86C	0.5	
------------	--	--	-------------------	-----	--

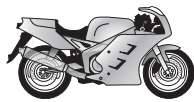
**21****mm****POWER
SPORT**

MAGNI						
1000cc	Australia (Guzzi V2)		RAX92C	0.7	8809	
1100cc	SFIDA (Guzzi V2)		RAX92C	0.7	8809	
MAICO						
50cc	MD		L77JC4	0.7	8883	
	Mofa		OE037 L86C	0.7		
	Wiesel		OE037 L86C	0.7		
125cc	Blizzard		OE037 L86C	0.5		
	GS	→1973	L77JC4	1.0	8883	
	GS K		OE040 N2C	0.5	8904	
	M		OE037 L86C	0.5		
	M 126		OE037 L86C	0.5		
	MC		OE040 N2C	0.5	8904	
	MC K	→1973	L77JC4	1.0	8883	
	MD SS	→1973	L77JC4	1.0	8883	
	Moto-cross		L78C	0.5	8883	
	Road racer		L78C	0.5	8883	
	RS		QL55	0.4		
	SG		OE040 N2C	0.5	8904	
	Typhon		OE086 RL82C	0.5	8814	
	150cc	M		OE037 L86C	0.5	
M 151			OE037 L86C	0.5		
M 153			OE037 L86C	0.5		
M 156			OE037 L86C	0.5		
Macomobil MB			L82C	0.7	8814	
175cc	Fanal		OE086 RL82C	0.5	8814	
	M		OE037 L86C	0.5		
	M SS		L77JC4	0.7	8883	
	Maicoletta		L77JC4	0.7	8883	
	Passat		L82C	0.5	8814	
200cc	M		OE037 L86C	0.5		
	Macomobil MB		L82C	0.7	8814	
250cc	Cross / Enduro	1990→	QC59C			
	GM Star		OE040 N2C	0.5	8904	
	GM Star E		OE040 N2C	0.5	8904	
	GS		L77JC4	1.0	8883	
	GS 5		OE040 N2C	0.5	8904	
	GS E		OE040 N2C	0.5	8904	
	GS T		OE040 N2C	0.5	8904	
	M		OE040 N2C	0.5	8904	
	M B		L77JC4	0.7	8883	
	M Military		OE037 L86C	0.5		
	M S I / Blizzard		L77JC4	1.0	8883	
	M S II / Blizzard		OE037 L86C	0.5		
	M SS		L77JC4	0.7	8883	
	Magnum		OE040 N2C	0.5	8904	
	Maicoletta		L77JC4	0.7	8883	
	MC	→1972	L77JC4	1.0	8883	
	MC		QC57C	0.5		
	MC T		OE040 N2C	0.5	8904	
	MD		OE040 N2C	0.5	8904	
	T-5		L78C	0.5	8883	
277cc	M		OE037 L86C	0.5		
	M S		OE037 L86C	0.5		
	Maicoletta		L77JC4	0.7	8883	

**MAICO**

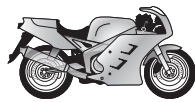
**21****POWER SPORT****...MAICO**

320cc	Cross / Enduro	1990 →		QC59C		
350cc	GS			L77JC4	0.5	8883
	Taifun		OE086	RL82C	0.5	8814
360cc	Cross / Enduro	1992 →		QC59C		
	GS			L77JC4	1.0	8883
380cc	Cross / Enduro	1991 →		QC59C		
400cc	500		OE037	L86C	0.5	
	GS T		OE091	RN2C	0.5	8904
	MC		OE091	RN2C	0.5	8904
	MC T	→1972		L77JC4	1.0	8883
	Taifun			L77JC4	1.0	8883
	X5			L77JC4	1.0	8883
	X5			L78C	0.5	8883
	440cc	Cross / Enduro	1992 →		QC59C	
GS			OE040	N2C	0.5	8904
MC T			OE040	N2C	0.5	8904
T			OE040	N2C	0.5	8904
450cc	MC		OE040	N2C	0.5	8904
490cc	GS / GSE		OE040	N2C	0.5	8904
	MC		OE040	N2C	0.5	8904
500cc	Cross / Enduro	1990 →		QC59C		
	GS		OE040	N2C	0.5	8904
	GS Star		OE040	N2C	0.5	8904
	GS Star E		OE040	N2C	0.5	8904
	MC		OE040	N2C	0.5	8904
	Z5			QN84	0.5	
610cc	Sidecar	1991 →	OE078	N3G	0.6	8904
640cc	Sidecar Twin Cylinder	1991 →		QC59C		
685cc	Gespann	1994 →		C55	0.6	

MALAGUTI

50cc	Cavalcone		OE037	L86C	0.5	
	Cavalcone		OE037	L86C	0.5	
	Custom Fox		OE037	L86C	0.5	
	Dribbling			RN5C	0.6	8339
	Drop 4 Marce			RN5C	0.6	8339
	Dune		OE098	RN4C	0.5	8339
	Europino 3 Marce		OE037	L86C	0.5	
	Europino GT		OE037	L86C	0.5	
	Fifty		OE086	RL82C	0.5	8814
	Fifty CX		OE086	RL82C	0.5	8814
	Fifty Evolution		OE098	RN4C	0.5	8339
	Fifty HF Mix		OE068	N3C	0.5	8904
	Fifty Top		OE068	N3C	0.5	8904
	Gran Turismo 3 Marce		OE037	L86C	0.5	
	Hombre		OE037	L86C	0.5	
	MDX Gold		OE098	RN4C	0.5	8339
	MEX		OE098	RN4C	0.5	8339
	MFX		OE098	RN4C	0.5	8339
	MGX		OE098	RN4C	0.5	8339
	Minicross		OE037	L86C	0.5	
	MLX		OE098	RN4C	0.5	8339
	Motorik		OE037	L86C	0.5	
	Motorik Junior			RN5C	0.6	8339
	MRX		OE098	RN4C	0.5	8339

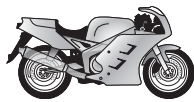
**21****POWER
SPORT****...MALAGUTI****...50cc**

Olympique		OE037	L86C	0.5	
Prisma		OE037	L86C	0.5	
Quattrotto			RN5C	0.6	8339
Ranocchio Baby		OE037	L86C	0.5	
RCX 12			L78C	0.5	8883
RCX 4			L78C	0.5	8883
RGT			RN5C	0.6	8339
Ronco 21		OE037	L86C	0.5	
RST			QN84	0.5	
Sportivo		OE037	L86C	0.5	
Super		OE037	L86C	0.5	
Super Cinque		OE037	L86C	0.5	
Super Cross		OE037	L86C	0.5	
Super Quattro		OE037	L86C	0.5	
Supertre		OE037	L86C	0.5	
Totem Rally			RN5C	0.6	8339
Trial 4M			RN5C	0.6	8339
Trial 6M			RN5C	0.6	8339
Turbo			RN5C	0.6	8339

75cc

Dune Enduro		OE079	N4C	0.5	8339
RST Turismo		OE079	N4C	0.5	8339

80cc

Cavalcone		OE068	N3C	0.5	8904
Chopper		OE068	N3C	0.5	8904

100cc

F12 Phantom	1999 →	OE086	RL82C	0.6	8814
-------------	--------	--------------	-------	-----	------

125cc

Cavalcone		OE040	N2C	0.5	8904
Cavalcone Cross Corsa		OE068	N3C	0.5	8904
Runner / YLC		OE068	N3C	0.5	8904
Runner Rally		OE068	N3C	0.5	8904

MALANCA**50cc**

Bibi		OE037	L86C	0.5	
Big		OE037	L86C	0.5	
Competizione		OE037	L86C	0.5	
Country 4M, 5M		OE037	L86C	0.5	
Country Special 4M, 5M		OE037	L86C	0.5	
Cross 3M		OE037	L86C	0.5	
Due Piu		OE037	L86C	0.5	
Duplimatic		OE037	L86C	0.5	
Export		OE037	L86C	0.5	
GTSS H20		OE037	L86C	0.5	
In		OE037	L86C	0.5	
Jolly 3M		OE037	L86C	0.5	
Jolly B		OE037	L86C	0.5	
Leoncino 3M, 4M		OE037	L86C	0.5	
Lord		OE037	L86C	0.5	
Mascotte B 4M, 5M		OE037	L86C	0.5	
Minizeta 4M, 5M		OE037	L86C	0.5	
RG 4M, 5M		OE037	L86C	0.5	
ST		OE037	L86C	0.5	
ST54		OE037	L86C	0.5	
Testa Rossa 4M, 5M		OE037	L86C	0.5	
Tigre 4M, 5M		OE037	L86C	0.5	
Tigrotto		OE037	L86C	0.5	
Turbo		OE037	L86C	0.5	
Turismo		OE037	L86C	0.5	
Zeta		OE037	L86C	0.5	

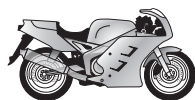

**21****POWER SPORT****...MALANCA**

125cc	E2C Scrambler, GT Sport Turismo	OE086	RL82C	0.5	8814	
	E2CS Scrambler, GT Sport Turismo	OE086	RL82C	0.5	8814	
	GTI	OE086	RL82C	0.5	8814	
	Mark		L77JC4	1.0	8883	
	OB One		L77JC4	1.0	8883	
150cc	3GTS	OE086	RL82C	0.5	8814	
	E2C	OE086	RL82C	0.5	8814	
	GT Strada	OE086	RL82C	0.5	8814	

MANCO

	Mini Bike - B&S 3, 3.5, 5, 8, 9 & 11 h.p.		RJ19LM	0.8		
	Mini Bike - B&S 9 h.p. Vanguard		RC14YC	0.8	8071	
	Mini Bike - Honda 6.5, 9, 11 & 13 h.p.	OE051	RN11YC	0.8	8405	
	Mini Bike - Robin 13.5 h.p. 4 cyl. OHV	OE006	RN9YC	0.7	8415	
	Mini Bike - Robin 4 h.p. 4 cycle OHV/OHC	OE098	RN4C	0.7	8339	
	Mini Bike - Robin 7 h.p. 4 cycle OHV/OHC		RL86C	0.7		
	Mini Bike - Tec. 3.5, 8, 9 & 10 h.p.		RJ8C	0.8		
	Mini Bike - Tec. 5 & 5.5 h.p. OHV	OE098	RN4C	0.8	8339	
	Mini Bike w/Tec. Engs.		RJ8C	0.8		

MANUFANCE

	All models	OE037	L86C	0.5		
--	------------	--------------	------	-----	--	--

MARS

25cc	M 25	OE037	L86C	0.8		
50cc	Enduro Dakarino		L78C	0.6	8883	
	M 25 Mini Califo	OE037	L86C	0.8		
	M 50	OE037	L86C	0.8		

MBK

49cc	41	OE037	L86C	0.5		PRO-5M
	88	OE037	L86C	0.5		
	89	OE037	L86C	0.5		
	41J	OE037	L86C	0.5		PRO-5M
	50 EV	OE037	L86C	0.5		PRO-5M
	50 EW	OE037	L86C	0.5		PRO-5M
	50 EWK	OE037	L86C	0.5		PRO-5M
	50 KW	OE037	L86C	0.5		PRO-5M
	50 L	OE037	L86C	0.5		PRO-5M
	50 S	OE037	L86C	0.5		PRO-5M
	50 VL	OE037	L86C	0.5		PRO-5M
	50 VS	OE037	L86C	0.5		PRO-5M
	51 NW / New West	OE037	L86C	0.5		PRO-5M
	51 RLK	OE068	N3C	0.5	8904	PRO-5M
	51 Speciale	OE037	L86C	0.5		
	51 SUK 12mm/1/2in.	OE068	N3C	0.5	8904	PRO-5M
	51 SUK 19mm/3/4in.	OE037	L86C	0.5		PRO-5M
	51 Super	OE037	L86C	0.5		PRO-5M
	51 Super Black Machine	OE037	L86C	0.5		PRO-5M
	51 Super Special	OE037	L86C	0.5		PRO-5M
	51J	OE037	L86C	0.5		PRO-5M
	51S	OE037	L86C	0.5		PRO-5M
	51SL	OE037	L86C	0.5		PRO-5M
	51V	OE037	L86C	0.5		PRO-5M
	51VL	OE037	L86C	0.5		PRO-5M
	88 IP	OE037	L86C	0.5		PRO-5M
	88 IU	OE037	L86C	0.5		PRO-5M

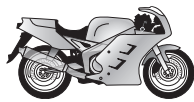
**21****POWER
SPORT****...MBK****...49cc**

AV 40	OE037	L86C	0.5		PRO-5M
AV 42	OE037	L86C	0.5		PRO-5M
AV 44	OE037	L86C	0.5		PRO-5M
AV 46	OE037	L86C	0.5		PRO-5M
AV 48	OE037	L86C	0.5		PRO-5M
AV 56	OE037	L86C	0.5		PRO-5M
AV 59	OE037	L86C	0.5		PRO-5M
AV 65	OE037	L86C	0.5		PRO-5M
AV 68	OE037	L86C	0.5		PRO-5M
AV 76	OE037	L86C	0.5		PRO-5M
AV 79	OE037	L86C	0.5		PRO-5M
AV 85	OE037	L86C	0.5		PRO-5M
AV 88	OE037	L86C	0.5		PRO-5M
AV 89	OE037	L86C	0.5		PRO-5M
AV 92	OE037	L86C	0.5		PRO-5M
AV 98	OE037	L86C	0.5		PRO-5M
Cady	OE037	L86C	0.5		PRO-5M
CF	OE037	L86C	0.5		PRO-5M
Champ	OE037	L86C	0.5		PRO-5M
Daytona Beach	OE037	L86C	0.5		PRO-5M
Daytona Cruiser	OE037	L86C	0.5		PRO-5M
FXK	OE037	L86C	0.5		PRO-5M
G 40	OE037	L86C	0.5		PRO-5M
G 50	OE037	L86C	0.5		PRO-5M
Hobby IV	OE001	N9YC	0.5	8415	PRO-5M
KW Magnum	OE037	L86C	0.5		PRO-5M
M 1	OE037	L86C	0.5		PRO-5M
M 1L	OE037	L86C	0.5		PRO-5M
M 1P	OE037	L86C	0.5		PRO-5M
M 1PR	OE037	L86C	0.5		PRO-5M
M 1PRT	OE037	L86C	0.5		PRO-5M
M 1PRTS	OE037	L86C	0.5		PRO-5M
Mobylett	OE037	L86C	0.5		PRO-5M
N 40	OE037	L86C	0.5		PRO-5M
N 50	OE037	L86C	0.5		PRO-5M
Rock	OE037	L86C	0.5		PRO-5M
SP 50	OE037	L86C	0.5		PRO-5M
SP 92	OE037	L86C	0.5		PRO-5M
SP 93	OE037	L86C	0.5		PRO-5M
SP 94	OE037	L86C	0.5		PRO-5M
SP 98	OE037	L86C	0.5		PRO-5M
SP 99	OE037	L86C	0.5		PRO-5M
Weekly		L82C	0.5	8814	PRO-5M
X 1	OE037	L86C	0.5		PRO-5M
X 1L	OE037	L86C	0.5		PRO-5M
X 7L	OE037	L86C	0.5		PRO-5M
X 7S	OE037	L86C	0.5		PRO-5M
X 7VL	OE037	L86C	0.5		PRO-5M
X 7VS	OE037	L86C	0.5		PRO-5M
ZX	OE086	RL82C	0.5	8814	PRO-5M

**MBK**

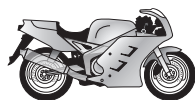
**21****POWER
SPORT****...MBK**

50cc				mm		
89	→1983		L82C	0.5	8814	PRO-5M
93			L82C	0.5	8814	PRO-5M
98	→1983		L82C	0.5	8814	PRO-5M
99			L82C	0.5	8814	PRO-5M
151 L	1979→1983	OE037	L86C	0.5		
151 LB	1979→1983	OE037	L86C	0.5		
151 LC	1979→1983	OE037	L86C	0.5		
50 R			L82C	0.5	8814	
50 VL	1971→1980	OE037	L86C	0.5		
50 VLC	1971→1980	OE037	L86C	0.5		
51 SU	1981→1983	OE037	L86C	0.5		
Club ,VR			L82C	0.6	8814	
Club Swing			L82C	0.5	8814	
Club VR Tex Mex			L82C	0.5	8814	
Collection			L82C	0.6	8814	
D50			L82C	0.5	8814	PRO-5M
DT R X-Limit		OE040	N2C	0.6	8904	
DX S			L82C	0.5	8814	
Equalis			L82C	0.5	8814	
Evasion			L82C	0.6	8814	
Hot Champ			L82C	0.5	8814	PRO-5M
Jazz, Hard Rock			L82C	0.6	8814	
Mag Max		OE040	N2C	0.6	8904	
Magnum Racing		OE040	N2C	0.6	8904	
Magnum Racing XR		OE037	L86C	0.5		
Monty MB3V	1977→1983	OE001	N9YC	0.5	8415	PRO-5M
Monty SP3V	→1981	OE001	N9YC	0.5	8415	PRO-5M
Monty SP3V	1981→	OE037	L86C	0.5		PRO-5M
Passion		OE040	N2C	0.6	8904	
Roadster		OE040	N2C	0.6	8904	
SP 94 TT			L82C	0.5	8814	PRO-5M
Spirit			RL78C		8883	
X power	2003→	OE091	RN2C	0.8	8904	
X-Power	1996→	OE108	RN3C	0.7	8904	
75cc			L78C	0.5	8883	PRO-5M
80cc			L82C	0.5	8814	PRO-5M
81 UP			L82C	0.5	8814	PRO-5M
88 LM881			L82C	0.5	8814	PRO-5M
881 UPTT			L82C	0.5	8814	PRO-5M
881P			L82C	0.5	8814	PRO-5M
881U			L82C	0.5	8814	PRO-5M
Active			L82C	0.5	8814	
B89			L82C	0.5	8814	
BP89			L82C	0.5	8814	
M11		OE037	L86C	0.5		PRO-5M
YE (4MU)	1995→		L82C	0.5	8814	PRO-5M
ZX50			L82C	0.5	8814	
100cc			RL78C		8883	
125cc			L78C	0.5	8883	PRO-5M
125 12,7 mm			L78C	0.5	8883	PRO-5M
125 19,0 mm		OE068	N3C	0.5	8904	PRO-5M
Active			Z9Y	0.6		
Active XC125			L82C	0.5	8814	
250cc			L82C	0.5	8814	
250		OE068	N3C	0.5	8904	PRO-5M
350cc			L82C	0.5	8814	
350	1973→1979	OE068	N3C	0.5	8904	PRO-5M
350 E		OE068	N3C	0.5	8904	PRO-5M
350 Injection		OE068	N3C	0.5	8904	PRO-5M

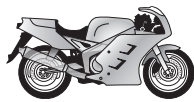
**21****POWER SPORT****MECATECNO**

50cc	Chic / Funny		OE037	L86C	0.5		
	Chic / Funny 2		OE037	L86C	0.5		
	Cuc		OE037	L86C	0.5		
	Dragonfly / Schoolboy		OE037	L86C	0.5		
	Grac		OE037	L86C	0.5		
	Hobby		OE037	L86C	0.5		
	Huracan		OE037	L86C	0.5		
	Micro GP		OE037	L86C	0.5		
	Mini 4		OE037	L86C	0.5		
	Racing CR-7		OE040	N2C	0.5	8904	
Tanga		OE037	L86C	0.5			

330cc	Dragon Fly / Sky Walker		OE045	RN11YCC	0.8	8405	
	MR 326 Trial		OE045	RN11YCC	0.8	8405	

MERLIN

50cc	DG1		OE037	L86C	0.5		
	DG2 T		OE037	L86C	0.5		
125cc	DG7			RN5C	0.5	8339	
350cc	Cresta		OE045	RN11YCC	0.8	8405	
	DG3		OE045	RN11YCC	0.8	8405	
	FIUS		OE045	RN11YCC	0.8	8405	
	GR		OE045	RN11YCC	0.8	8405	
	Trial		OE045	RN11YCC	0.8	8405	

410cc	DG11 500		OE037	L86C	0.5		
--------------	----------	--	--------------	------	-----	--	--

452cc	Nomada (Cagiva mot.)		OE083	RA6HC	0.5	8809	
--------------	----------------------	--	--------------	-------	-----	-------------	--

500cc	Nomada (Cagiva mot.)	1987→	OE083	RA6HC	0.5	8809	
--------------	----------------------	-------	--------------	-------	-----	-------------	--

METALURGIA CASAL(→Casal)**METEORIT / ATU**

125cc	Cruiser		OE083	RA6HC	0.5	8809	
--------------	---------	--	--------------	-------	-----	-------------	--

MICHRINA

	Mini Bike All Models			RJ8C	0.8		
--	----------------------	--	--	------	-----	--	--

MICRO-SOUND

	Mini Bike w/Chry. 61014 Engs.			RL86C	0.8		
--	-------------------------------	--	--	-------	-----	--	--

MIDWEST

50cc	Dingo 50, Fox 50			RL86C	0.8		
	JC50Q-9	2000→		P-RZ9HC	0.7		

70cc	JC70Y	2000→		P-RZ9HC	0.7		
	JS70Y	2000→		P-RZ9HC	0.7		

80cc	Coyote 80			RL87YC	0.8		
-------------	-----------	--	--	--------	-----	--	--

90cc	JS90Y	2000→		P-RZ9HC	0.7		
-------------	-------	-------	--	---------	-----	--	--

100cc	Cougar 100		OE108	RN3C	0.8	8904	
--------------	------------	--	--------------	------	-----	-------------	--

125cc	Hunter 125		OE083	RA6HC	0.8	8809	
--------------	------------	--	--------------	-------	-----	-------------	--

150cc	JC150Y	2000→	OE083	RA6HC	0.7	8809	
--------------	--------	-------	--------------	-------	-----	-------------	--

200cc	JS200Y	2000→	OE083	RA6HC	0.7	8809	
--------------	--------	-------	--------------	-------	-----	-------------	--

MINARELLI

50cc	C2 12,7mm/1/2in.		OE037	L86C	0.5		
	C2 19mm/3/4in.			RN5C	0.5	8339	
	C3KS			RN5C	0.5	8339	
	C3KS 19mm/3/4in.		OE037	L86C	0.5		
	C3PK			RN5C	0.5	8339	
	C3PK 19mm/3/4in.		OE037	L86C	0.5		
	Cross			QN84	0.5		

**MINARELLI**

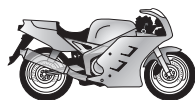
**21****POWER
SPORT****...MINARELLI****...50cc**

DL3	OE091	RN2C	0.5	8904
E2 12,7mm/1/2in.	OE037	L86C	0.5	
E2 19mm/3/4in.		RN5C	0.5	8339
G1		RN5C	0.5	8339
G1 12,7mm/1/2in.	OE037	L86C	0.5	
G1R		RN5C	0.5	8339
G1SKS		RN5C	0.5	8339
H3	OE086	RL82C	0.5	8814
P3A	OE086	RL82C	0.5	8814
P3N	OE086	RL82C	0.5	8814
P3S	OE086	RL82C	0.5	8814
P4	OE037	L86C	0.5	
P4A	OE037	L86C	0.5	
P4CS	OE098	RN4C	0.5	8339
P4CSA	OE098	RN4C	0.5	8339
P4E	OE086	RL82C	0.5	8814
P4R	OE098	RN4C	0.5	8339
P6	OE037	L86C	0.5	
P6 Competition		G59C	0.4	8698
P6 Super		L78C	0.5	8883
P6CS	OE098	RN4C	0.5	8339
P6CSA	OE098	RN4C	0.5	8339
P6E	OE037	L86C	0.5	
P6R	OE098	RN4C	0.5	8339
RV	OE098	RN4C	0.5	8339
RV4	OE098	RN4C	0.5	8339
RV4A	OE098	RN4C	0.5	8339
Svizzera Cat.	OE007	L87YC	0.5	
Trial		G59C	0.4	8698
V1	OE037	L86C	0.5	
V1 12,7mm/1/2in.		RN5C	0.5	8339
V1A	OE037	L86C	0.5	
V1A 12,7mm/1/2in.		RN5C	0.5	8339
V1H	OE037	L86C	0.5	
V1H 12,7mm/1/2in.	OE086	RL82C	0.5	8814
V1KS	OE037	L86C	0.5	
V1KS 12,7mm/1/2in.		RN5C	0.5	8339
V1L	OE086	RL82C	0.5	8814
V1LHE	OE086	RL82C	0.5	8814
V1LKS		RN5C	0.5	8339
V1P	OE037	L86C	0.5	
V1P 12,7mm/1/2in.		RN5C	0.5	8339
V2		RN5C	0.5	8339
V2 19mm/3/4in.	OE037	L86C	0.5	
W3QM	OE086	RL82C	0.5	8814
60cc W3QM Export	OE086	RL82C	0.5	8814
75cc Trial		QN84	0.4	
80cc MR 6		QN84	0.5	
P6	OE086	RL82C	0.5	8814

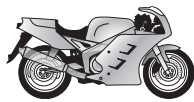
**21****POWER
SPORT****...MINARELLI**

125cc	/5		OE108	RN3C	0.5	8904
	Cross			G59C	0.4	8698
	Cross 761 25, 5			QN84	0.5	
	Regolarità			G59C	0.4	8698
	Regolarità 125, 6			QN84	0.5	
	TZR DT		OE091	RN2C	0.5	8904
	TZR RD		OE108	RN3C	0.5	8904
	YPVS Lic.Yamaha		OE108	RN3C	0.5	8904

MINATI

	Mini Bike - B&S 5 h.p.			RJ19LM	0.8	
	Mini Bike - Honda 5.5 h.p.		OE051	RN11YC	0.8	8405
	Mini Bike - Tec. 13 h.p.		OE086	RL82C	0.8	8814
	Mini Bike - Tec. 3.5 h.p.			RJ19LM	0.8	
	Mini Bike - Tec. 5 h.p. OHV		OE098	RN4C	0.8	8339

MINSK

125cc	MMB3-3.112		OE038	L82YC	0.7	8814
	MMB3-3.113		OE038	L82YC	0.7	8814
	MMB3-3.1131		OE038	L82YC	0.7	8814
	MMB3-3.11311		OE038	L82YC	0.7	8814
	Mototeleschka C-3.901		OE038	L82YC	0.7	8814

MOBYLETTE (GAC)

49cc	Ciclomotori		OE086	RL82C	0.5	8814
-------------	-------------	--	--------------	-------	-----	-------------

MONARK

125cc	1228		OE037	L86C	0.5	
	1238		OE037	L86C	0.5	
	1248		OE037	L86C	0.5	
	1379		OE037	L86C	0.5	
	Automat		OE037	L86C	0.5	
	Compact		OE037	L86C	0.5	
	Compact Custom		OE037	L86C	0.5	
	ISDT		OE086	RL82C	0.5	8814
	LM16		OE037	L86C	0.5	
	MX		OE086	RL82C	0.5	8814
	SS 50		OE037	L86C	0.5	
	Standard		OE037	L86C	0.5	
	T		OE086	RL82C	0.5	8814
	TS80			L78C	0.5	8883
	TTS		OE086	RL82C	0.5	8814

MONDIAL

48cc	All models		OE086	RL82C	0.5	8814
50cc	Cross Spezial			L82C	0.5	8814
	Mondialino			L82C	0.5	8814
	Radial			L78C	0.5	8883
	Regolarità			L78C	0.5	8883
	Spezial V4 Record		OE079	N4C	0.5	8339
	Touring			L78C	0.5	8883
	Tourismo			L82C	0.5	8814
125cc	Cross Radial v6			L82C	0.5	8814
	SS			QL55	0.4	
160cc	All models		OE086	RL82C	0.5	8814
175cc	SS			QL55	0.4	
1000cc	Piega VTR 1000 SP	2003→		QC59YC		

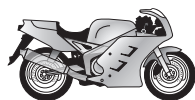

**21****POWER SPORT****MONTESA**

Capacity	Model	Part No.	Thread	Gap (mm)	Part No.	Part No.
50cc	Brio		L82C	0.5	8814	PRO-5M
	Cirlo		L82C	0.5	8814	PRO-5M
	Cota 25 A, C	OE037	L86C	0.5		PRO-5M
	Cota Trial	OE068	N3C	0.5	8904	PRO-5M
	Evasion	OE008	RN7YCC	0.7	8332	PRO-5M
	Fura		L82C	0.5	8814	PRO-5M
	Mini Cota		L82C	0.5	8814	PRO-5M
	Mini Montesa / 49		L82C	0.5	8814	PRO-5M
	MTX (Peugeot mot.)	OE091	RN2C	0.5	8904	PRO-5M
	Scorpion 50R		L82C	0.5	8814	PRO-5M
	SH (Peugeot mot.)	OE007	L87YC	0.5		PRO-5M
75cc	74 / 74T	OE091	RN2C	0.5	8904	PRO-5M
	80 H7	OE091	RN2C	0.5	8904	PRO-5M
	Cota	OE091	RN2C	0.5	8904	PRO-5M
	Crono	OE091	RN2C	0.5	8904	PRO-5M
	Enduro	OE091	RN2C	0.5	8904	PRO-5M
	Enduro H6	OE091	RN2C	0.5	8904	PRO-5M
	Enduro L	OE091	RN2C	0.5	8904	PRO-5M
	SH (Peugeot mot.)	OE007	L87YC	0.5		PRO-5M
	123cc	Cota / C / T	OE098	RN4C	0.5	8339
MH		OE098	RN4C	0.5	8339	PRO-5M
125cc	Cappra VA, VB, VE, VF		QN84	0.5		PRO-5M
	Cappra VG		QN84	0.5		PRO-5M
	Cota	OE098	RN4C	0.5	8339	PRO-5M
	Cota	OE045	RN11YCC	0.8	8405	PRO-5M
	Cota Blanca	OE098	RN4C	0.5	8339	PRO-5M
	Cota T	OE045	RN11YCC	0.8	8405	PRO-5M
	Crono	OE108	RN3C	0.5	8904	PRO-5M
	Enduro H6	OE108	RN3C	0.5	8904	PRO-5M
	Enduro H7	OE108	RN3C	0.5	8904	PRO-5M
	Impala	OE037	L86C	0.5		PRO-5M
	175cc	Cota 172 / 200	OE098	RN4C	0.5	8339
Impala 2 / Sport		OE037	L86C	0.5		PRO-5M
Impala Comando / Turismo		OE037	L86C	0.5		PRO-5M
Kenya		OE037	L86C	0.5		PRO-5M
Texas		OE037	L86C	0.5		PRO-5M
200cc	Cota Blanca	OE045	RN11YCC	0.8	8405	PRO-5M
	MH	OE008	RN7YCC	0.5	8332	PRO-5M
240cc	Cota 304	OE045	RN11YCC	0.8	8405	PRO-5M
	Cota 307	OE008	RN7YCC	0.6	8332	PRO-5M
250cc	Automix	OE108	RN3C	0.5	8904	PRO-5M
	Cappra CA, VB, VE, VR, VF, VG	OE040	N2C	0.5	8904	PRO-5M
	Cappra GP / MX		L78C	0.5	8883	PRO-5M
	Cota 242	OE008	RN7YCC	0.5	8332	PRO-5M
	Cota 247	OE045	RN11YCC	0.5	8405	PRO-5M
	Cota 247 C/T	OE037	L86C	0.5		PRO-5M
	Cota 248 Blanca	OE008	RN7YCC	0.8	8332	PRO-5M
	Cota 304 / 307	OE008	RN7YCC	0.8	8332	PRO-5M
	Enduro H, K, H6, H7	OE108	RN3C	0.5	8904	PRO-5M
	Enduro Rapita Automix	OE108	RN3C	0.5	8904	PRO-5M
	Impala King / Scorpion / Sport		L78C	0.5	8883	PRO-5M
	King Scorpion		L78C	0.5	8883	PRO-5M
	Scorpion		L78C	0.5	8883	PRO-5M
309cc	Cota	OE018	RN7YC	0.7	8332	PRO-5M

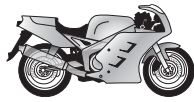
**21****POWER SPORT****...MONTESA**

310cc	Cota / Evasion / Trial		OE022	N9YCC	0.7	8415	PRO-5M
	Cota 348 Trial		OE022	N9YCC	0.7	8415	PRO-5M
311cc	Cota		OE022	N9YCC	0.7	8415	PRO-5M
315cc	Cota R	1997→		RN5C	0.7	8339	PRO-5M
330cc	Cota / Trial		OE045	RN11YCC	0.8	8405	PRO-5M
335cc	Cota		OE045	RN11YCC	0.8	8405	PRO-5M
349cc	MH		OE045	RN11YCC	0.8	8405	PRO-5M
350cc	Cappra 360 GP / VA / VB		OE108	RN3C	0.5	8904	PRO-5M
	Cappra 360VA			QN86	0.5		PRO-5M
	Cappra 360VB			QN86	0.5		PRO-5M
	Cappra GP			QN86	0.5		PRO-5M
	Cota 348		OE045	RN11YCC	0.8	8405	PRO-5M
	Cota 348T		OE045	RN11YCC	0.8	8405	PRO-5M
	Cota 349 Trial		OE045	RN11YCC	0.8	8405	PRO-5M
	Cota 349T		OE045	RN11YCC	0.8	8405	PRO-5M
	Crono		OE108	RN3C	0.5	8904	PRO-5M
	Enduro 360 H6, H7, H7S		OE108	RN3C	0.5	8904	PRO-5M
414cc	Cappra 414VG			QN86	0.5		
	Cappra VE			QN86	0.5		
	Cappra VF			QN84	0.5		

MORBIDELLI

125cc	Water cooled			C53CX	0.5		
--------------	--------------	--	--	-------	-----	--	--

MOSQUITO

50cc	Predator			RCJ8Y	0.8		
90cc	Predator			RCJ8Y	0.8		

MOTO BM

49cc	Colombina 21		OE037	L86C	0.6		
	Colombina 8		OE037	L86C	0.6		
	Cross		OE037	L86C	0.6		
	Dai-Dai		OE037	L86C	0.6		
	Dog		OE037	L86C	0.6		
	Export		OE037	L86C	0.6		
	Gambalesta 15		OE037	L86C	0.6		
	Gambalesta 17		OE037	L86C	0.6		
	Jaquarino		OE037	L86C	0.6		
	Jaquarino		OE037	L86C	0.6		
	Jaquarino Lusso Export		OE037	L86C	0.6		
	Trik-Trak 3 Turbo Export		OE037	L86C	0.6		
	Trik-Trak 4 Turbo Export		OE037	L86C	0.6		
	Turismo		OE037	L86C	0.6		
	Velocino		OE037	L86C	0.6		
	Wally Turbo		OE037	L86C	0.6		
	Zebretta 2		OE037	L86C	0.6		
125cc	Antares Cross		OE098	RN4C	0.6	8339	
	Antares Gran Turismo		OE098	RN4C	0.6	8339	
	Gran		OE098	RN4C	0.6	8339	
	Sideral		OE098	RN4C	0.6	8339	
	Turismo		OE098	RN4C	0.6	8339	

**MOTO BM**

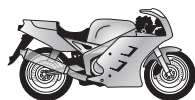
**21****POWER
SPORT****MOTO GEROSA**

50cc	Cross Corsa Minarelli		C57	0.5		
	Mini Pieghevole		OE037 L86C	0.6		
	Monotrave L 4M		OE074 N5C	0.7	8339	
	Motocarro		OE037 L86C	0.6		
	Pulce Bimbo		OE037 L86C	0.6		
	Pulce Junior 4M		OE074 N5C	0.7	8339	
	Regolarita Corsa Zündapp / 6M		OE068 N3C	0.5	8904	
	V1 Export		OE037 L86C	0.6		
	V1 Monotrave		OE037 L86C	0.6		
	V110		OE037 L86C	0.6		

MOTO GUZZI

50cc	Chiu		RN5C	0.5	8339	
	Cross		OE098 RN4C	0.5	8339	
	Dingo 3M / MM		OE037 L86C	0.5		
	Furghino		OE037 L86C	0.5		
	Magnum		RN5C	0.5	8339	
	Nibbio		OE098 RN4C	0.5	8339	
	Trotter		OE037 L86C	0.5		
75cc	Dingo Ranchera		OE037 L86C	0.5		
110cc	Lario		OE037 L86C	0.5		
125cc	2 C4T	1979 → 1983	RZ94C	0.6		
	Custom		OE091 RN2C	0.5	8904	
	TT		OE108 RN3C	0.5	8904	
	Turismo		OE108 RN3C	0.5	8904	
250cc	254	1978 → 1980	RZ94C	0.5		PRO-5M
	FD	1974 → 1976	OE083 RA6HC	0.5	8809	
	TS		OE108 RN3C	0.5	8904	PRO-5M
350cc	Florida		OE084 N6YCC	0.6	8902	
	GTS	1974 → 1980	OE083 RA6HC	0.5	8809	
	Nevada		OE108 RN3C	0.6	8904	
	NTX		OE084 N6YCC	0.6	8902	
	V35	1979 → 1986	OE084 N6YCC	0.6	8902	
	V35 Florida	1986 →	OE084 N6YCC	0.6	8902	
	V35 II	1980 → 1987	OE079 N4C	0.5	8339	PRO-5M
	V35 III	1985 →	OE084 N6YCC	0.6	8902	PRO-5M
	V35 Imola	1979 → 1987	OE079 N4C	0.5	8339	PRO-5M
	V35 Imola II	1979 → 1986	Z9Y	0.5		PRO-5M
	V35 TT	1984 → 1987	OE018 RN7YC	0.6	8332	PRO-5M
400cc	GTS	1975 → 1980	OE083 RA6HC	0.6	8809	
	Imola		OE084 N6YCC	0.6	8902	
	V40		OE084 N6YCC	0.6	8902	
500cc	Ercole		OE098 RN4C	0.5	8339	
	Falcone		OE098 RN4C	0.5	8339	
	Falcone Nuovo		OE098 RN4C	0.5	8339	
	Sahara		OE098 RN4C	0.5	8339	
	V50	1977 →	OE084 N6YCC	0.6	8902	
	V50 Custom	1978 → 1980	OE084 N6YCC	0.6	8902	
	V50 II	1979 → 1981	OE084 N6YCC	0.6	8902	
	V50 III	1981 → 1987	OE084 N6YCC	0.6	8902	
	V50 Monza II	1984 → 1987	Z9Y	0.6		

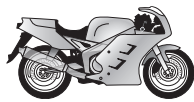
**21****POWER
SPORT****...MOTO GUZZI**

650cc	Florida		OE084	N6YCC	0.6	8902
	GT		OE084	N6YCC	0.6	8902
	NTX		OE084	N6YCC	0.6	8902
	V65	→1986	OE084	N6YCC	0.6	8902
	V65	1987→	OE005	RC9YC	0.5	
	V65 C		OE084	N6YCC	0.6	8902
	V65 Florida	→1986	OE084	N6YCC	0.6	8902
	V65 Florida	1992→	OE068	N3C	0.5	8904
	V65 Lario	→1986		Z9Y	0.6	
	V65 NTX	→1989	OE084	N6YCC	0.6	8902
	V65 NTX	1990→1992	OE068	N3C	0.5	8904
	V65 Polizia NT		OE068	N3C	0.5	8904
	V65 SP		OE084	N6YCC	0.6	8902
V65 TT		OE084	N6YCC	0.6	8902	
700cc	V7 Special		OE022	N9YCC	0.8	8415
	V7 Sport		OE022	N9YCC	0.8	8415
750cc	Breva Naked	2003→	OE108	RN3C	0.6	8904
	Breva Touring	2003→	OE108	RN3C	0.6	8904
	Dune		OE108	RN3C	0.6	8904
	Nevada Base	2000→	OE108	RN3C	0.6	8904
	Nevada Classic	2004→	OE108	RN3C	0.6	8904
	Nevada Club		OE108	RN3C	0.6	8904
	S		OE001	N9YC	0.8	8415
	SP		OE068	N3C	0.6	8904
	Targa		OE068	N3C	0.6	8904
	V NTX	1992→	OE068	N3C	0.6	8904
	V Polizia NT	1992→	OE068	N3C	0.6	8904
	V75		OE068	N3C	0.5	8904
	V75 Duna			Z9Y	0.6	
V75 Nevada	1992→	OE068	N3C	0.5	8904	
850cc	California	1975→1981	OE001	N9YC	0.7	8415
	Le Mans Mk II, Mk III	1978→1981	OE001	N9YC	0.8	8415
	T3		OE001	N9YC	0.8	8415
	T4	1980→1983	OE001	N9YC	0.8	8415
	T5 California	1983→1987	OE001	N9YC	0.8	8415
	T5 5	1982→1984	OE001	N9YC	0.8	8415
877cc	Breva Twinspark Out	2006→	OE004	RN9YCC	0.6	8415
	Breva Twinspark In	2006→	OE122	RG4PHP		8698
	Griso Twinspark Out	2006→	OE004	RN9YCC	0.6	8415
	Griso Twinspark In	2006→	OE122	RG4PHP		8698
1000cc	1000		OE001	N9YC	0.6	8415
	California C.i.e. GT, S		OE084	N6YCC	0.6	8902
	Daytona	1992→		RAX92C	0.7	8809
	Daytona RS		OE084	N6YCC	0.6	8902
	Le Mans IV		OE084	N6YCC	0.6	8902
	Quota i.e.		OE084	N6YCC	0.6	8902
	Strada		OE001	N9YC	0.8	8415
	T5 Polizia	1992→	OE001	N9YC	0.8	8415
	V California California III		OE001	N9YC	0.8	8415
	V California California III Inj.		OE001	N9YC	0.8	8415
	V Convert, SP, SPII, SPIII, G5		OE084	N6YCC	0.6	8902
	V CX		OE084	N6YCC	0.6	8902
V10 Centauro - 1000 (Injection)	1996→		RAX92C	0.7	8809	

**MOTO GUZZI**

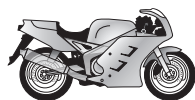
**21****POWER SPORT****...MOTO GUZZI**

Capacity	Model	Year	Part No.	Code	mm	Part No.
1100cc	Breva Twinspark Out	2006 →	OE004	RN9YCC	0.6	8415
	Breva Twinspark In	2006 →	OE122	RG4PHP		8698
	California Aluminium	2003 →	OE004	RN9YCC	0.6	8415
	California EV (KD)	1997 →	OE004	RN9YCC	0.6	8415
	California i (Air cooled)	2000 →	OE004	RN9YCC	0.6	8415
	California Jackal (KD)	1999 →	OE004	RN9YCC	0.6	8415
	California KC	1994 →	OE004	RN9YCC	0.6	8415
	California KD	1994 →	OE004	RN9YCC	0.6	8415
	California Special	2002 →	OE004	RN9YCC	0.6	8415
	California Special Sport (KD)	2002 →	OE004	RN9YCC	0.6	8415
	California Stone (KD)		OE004	RN9YCC	0.6	8415
	California Titanium	2003 →	OE004	RN9YCC	0.6	8415
	Daytona RS (KL)	1996 →	OE083	RA6HC	0.7	8809
	Griso Twinspark Out	2005 →	OE004	RN9YCC	0.6	8415
	Griso Twinspark In	2005 →	OE122	RG4PHP		8698
	Quota 1.1S (Air cooled)	1998 →	OE004	RN9YCC	0.8	8415
	Sport	1996 →	OE004	RN9YCC	0.6	8415
	Sport i (KF)	1996 →	OE004	RN9YCC	0.6	8415
	Stone Touring	2003 →	OE004	RN9YCC	0.6	8415
	V11 Le Mans (KS)		OE004	RN9YCC	0.7	8415
V11 Le Mans Nero Corsa	2004 →	OE004	RN9YCC	0.7	8415	
V11 Naked	2003 →	OE004	RN9YCC	0.7	8415	
V11 Rosso Mandello (KR)	1999 →	OE004	RN9YCC	0.7	8415	
V11 Scura	2003 →	OE004	RN9YCC	0.7	8415	
V11 Sport (KS)	1999 →	OE004	RN9YCC	0.7	8415	
1200cc	GT Twinspark Out	2006 →	OE004	RN9YCC	0.6	8415
	GT Twinspark In	2006 →	OE122	RG4PHP		8698
	Norge Twinspark Out	2006 →	OE004	RN9YCC	0.6	8415
	Norge Twinspark In	2006 →	OE122	RG4PHP		8698
1250cc	MGS 01	2004 →	OE073	RA4HC		

MOTO KOSMOS

100cc	RV100		OE040	N2C	0.5	8904
125cc	CV125		OE068	N3C	0.5	8904
	CVA125		OE040	N2C	0.5	8904
	KSR125		OE040	N2C	0.5	8904
	RV125		OE068	N3C	0.5	8904
250cc	CV250		OE068	N3C	0.5	8904
	KSR250		OE040	N2C	0.5	8904
	RV250		OE068	N3C	0.5	8904
350cc	RV350		OE068	N3C	0.5	8904
500cc	CV500		OE068	N3C	0.5	8904

MOTO MERIDEN (→ Triumph)**MOTO MORINI**

49cc	G304			QN84	0.5	
	RV		OE037	L86C	0.5	
	S5-B			L82C	0.5	8814
	S5-K2		OE037	L86C	0.5	
	T4		OE037	L86C	0.5	
	TA50		OE037	L86C	0.5	

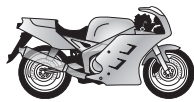
**21****POWER
SPORT****...MOTO MORINI**

50cc	Corsarino ZZ50		OE098	RN4C	0.5	8339	
	Dollaro		OE098	RN4C	0.5	8339	
	G30			L82C	0.5	8814	
	G30A			L82C	0.5	8814	
	RV50			L82C	0.5	8814	
	Scrambler		OE098	RN4C	0.5	8339	
	Super Scrambler ZI-Z		OE098	RN4C	0.5	8339	
80cc	80		OE022	N9YCC	0.8	8415	
	6-80		OE037	L86C	0.5		
100cc	R		OE108	RN3C	0.5	8904	
	Sbarazzino		OE108	RN3C	0.5	8904	
125cc	Corsaro Sport Lusso		OE008	RN7YCC	0.8	8332	
	Country		OE008	RN7YCC	0.8	8332	
	Country GT		OE008	RN7YCC	0.8	8332	
	Country SL		OE008	RN7YCC	0.8	8332	
	Country T		OE008	RN7YCC	0.8	8332	
	KJ		OE008	RN7YCC	0.8	8332	
	Monello		OE008	RN7YCC	0.8	8332	
	R		OE008	RN7YCC	0.8	8332	
	Strada		OE008	RN7YCC	0.8	8332	
	Super Sport		OE008	RN7YCC	0.8	8332	
	150cc	Corsaro		OE098	RN4C	0.5	8339
Corsaro GT150			OE098	RN4C	0.5	8339	
Corsaro GT150 Super			OE098	RN4C	0.5	8339	
GT			OE098	RN4C	0.5	8339	
R160			OE098	RN4C	0.5	8339	
Sport			OE098	RN4C	0.5	8339	
Sport			OE098	RN4C	0.5	8339	
SS			OE098	RN4C	0.5	8339	
Super			OE098	RN4C	0.5	8339	
165cc	Regolarità		OE098	RN4C	0.5	8339	
175cc	Corsaro Regolarità		OE108	RN3C	0.5	8904	
	M03		OE074	N5C	0.5	8339	
	M1		OE074	N5C	0.5	8339	
	M1S		OE074	N5C	0.5	8339	
	N1K		OE074	N5C	0.5	8339	
	Settebello		OE098	RN4C	0.5	8339	
	Tresette		OE098	RN4C	0.5	8339	
	Tresette Sprint		OE108	RN3C	0.5	8904	
	250cc	Bicilindro		OE008	RN7YCC	0.8	8332
350cc	31/2		OE008	RN7YCC	0.8	8332	
	31/2 Sport		OE008	RN7YCC	0.8	8332	
	Coguardo		OE008	RN7YCC	0.8	8332	
	Country		OE008	RN7YCC	0.8	8332	
	Dart		OE008	RN7YCC	0.8	8332	
	Excalibur		OE008	RN7YCC	0.8	8332	
	K2		OE008	RN7YCC	0.8	8332	
	Kanguro		OE008	RN7YCC	0.8	8332	
	Kanguro XE		OE008	RN7YCC	0.8	8332	
	New York		OE008	RN7YCC	0.8	8332	
	Strada		OE008	RN7YCC	0.8	8332	
400cc	Dart	1991→	OE008	RN7YCC	0.8	8332	
500cc	2 cyl. mot.	1982→	OE008	RN7YCC	0.8	8332	
	Camel	→1982	OE008	RN7YCC	0.8	8332	

**MOTO MORINI**

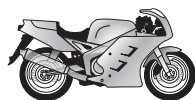
**21****POWER SPORT****...MOTO MORINI**

501cc	Camel, XE		OE008	RN7YCC	0.8	8332
	Coguardo		OE008	RN7YCC	0.8	8332
	Excalibur	1991 →	OE008	RN7YCC	0.8	8332
	New York	1991 →	OE008	RN7YCC	0.8	8332

1200cc	Corsaro	2005 →	OE092	RG4HC	0.7	8698
--------	---------	--------	-------	-------	-----	------

MOTO SPEZIAL

1100cc	Bassa Lunga	1999 →	OE001	N9YC	0.8	8415
	Sportiva i	1999 →	OE001	N9YC	0.8	8415

MOTO VESPA

49cc	Vale		OE086	RL82C	0.5	8814
	Vespa Delta		OE086	RL82C	0.5	8814
	Vespino		OE086	RL82C	0.5	8814

50cc	Vespino F9		OE091	RN2C	0.5	8904
	Vespino F9E		OE091	RN2C	0.5	8904

75cc	Vespa PK75S		OE037	L86C	0.5	
	Vespa PK75XL		OE086	RL82C	0.5	8814
	Vespa Primavera		OE037	L86C	0.5	

125cc	Cosa		OE091	RN2C	0.6	8904
	P CL		OE037	L86C	0.5	
	PK S		OE037	L86C	0.5	
	T5		OE091	RN2C	0.6	8904
	Vespa		OE086	RL82C	0.5	8814
	Vespa Primavera		OE086	RL82C	0.5	8814
	Vespa XL		OE108	RN3C	0.5	8904
	XL Plurimatic		OE086	RL82C	0.5	8814

150cc	Vespa 12,7mm/1/2in.		OE098	RN4C	0.5	8339
	Vespa 19mm/3/4in.		OE037	L86C	0.5	

200cc	Iris			RN5C	0.5	8339
	PX			RN5C	0.5	8339
	TX			RN5C	0.5	8339
	Vespa Cosa			RN5C	0.5	8339
	Vespa DN			RN5C	0.5	8339
	Vespa DS		OE091	RN2C	0.6	8904

MOTO VILLA

50cc	Minicross Comp		OE091	RN2C	0.5	8904
------	----------------	--	-------	------	-----	------

80cc	Minicross Comp		OE091	RN2C	0.5	8904
	Tempestino		OE091	RN2C	0.5	8904

125cc	Cross		OE091	RN2C	0.5	8904
	Cross Canguro		OE091	RN2C	0.5	8904
	Daytona			QC57	0.5	
	EA		OE091	RN2C	0.6	8904
	Italia		OE091	RN2C	0.6	8904
	MC		OE091	RN2C	0.5	8904
	MCA			QC57	0.5	
	Regolarità		OE091	RN2C	0.5	8904
	Rommel		OE108	RN3C	0.5	8904
	Scrambler		OE091	RN2C	0.5	8904
	Sebring		OE091	RN2C	0.5	8904
	SME		OE091	RN2C	0.5	8904
	TT4		OE091	RN2C	0.5	8904

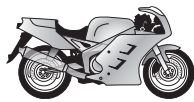
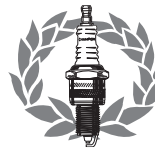
**21****POWER
SPORT****...MOTO VILLA**

250cc	Cross		QC57	0.5	
	Enduro	OE108	RN3C	0.5	8904
	MCA		QC57	0.5	
	Rommel	OE108	RN3C	0.5	8904
	Six Days	OE108	RN3C	0.5	8904
308cc	Everest 348	OE045	RN11YCC	0.8	8405
350cc	Rommel	OE091	RN2C	0.5	8904
380cc	Cross 350	OE091	RN2C	0.5	8904
	SME	OE091	RN2C	0.5	8904
450cc	Six Days 350	OE108	RN3C	0.5	8904
500cc	MCA 495		QC57	0.5	

MOTOBECANE (MBK/Yamaha)

49cc	AV	OE086	RL82C	0.4	8814
	AV 146	OE037	L86C	0.4	
	AV 188 TC	OE086	RL82C	0.4	8814
	AV 42	OE086	RL82C	0.4	8814
	AV 44	OE086	RL82C	0.4	8814
	AV 46	OE086	RL82C	0.4	8814
	AV 50 S	OE086	RL82C	0.4	8814
	AV 51	OE086	RL82C	0.4	8814
	AV 51	OE086	RL82C	0.4	8814
	AV 65	OE086	RL82C	0.4	8814
	AV 69	OE086	RL82C	0.4	8814
	AV 88	OE086	RL82C	0.4	8814
	AV 89	OE086	RL82C	0.4	8814
	AV 89 MB	OE086	RL82C	0.4	8814
	AV MR	OE086	RL82C	0.4	8814
	Cady	OE086	RL82C	0.4	8814
	D50 R	OE086	RL82C	0.4	8814
	D52	OE086	RL82C	0.4	8814
	D52 TT	OE086	RL82C	0.4	8814
	D55	OE086	RL82C	0.4	8814
	D89	OE086	RL82C	0.4	8814
	D98	OE086	RL82C	0.4	8814
	DL92	OE086	RL82C	0.4	8814
	DL93	OE086	RL82C	0.4	8814
	EEG	OE086	RL82C	0.4	8814
	EV50	OE086	RL82C	0.4	8814
	EV50	OE086	RL82C	0.4	8814
	EW50	OE086	RL82C	0.4	8814
	Gran	OE086	RL82C	0.4	8814
	Gran Sport	OE086	RL82C	0.4	8814
	GT92	OE086	RL82C	0.4	8814
	H40 S	OE086	RL82C	0.4	8814
	H40 TL	OE086	RL82C	0.4	8814
	H40 TLS	OE086	RL82C	0.4	8814
	H40 TS	OE086	RL82C	0.4	8814
	H40 V	OE086	RL82C	0.4	8814
	H40 VLC	OE086	RL82C	0.4	8814
	H40 VS	OE086	RL82C	0.4	8814
	H50 LS	OE086	RL82C	0.4	8814
	H50 S	OE086	RL82C	0.4	8814
	H50 VLC	OE086	RL82C	0.4	8814
	H50 VS	OE086	RL82C	0.4	8814

MOTOBECANE (MBK/Yamaha)

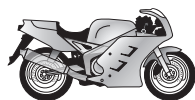
**21****POWER SPORT****...MOTOBECANE (MBK/Yamaha)****...49cc**

Hobby	OE004	RN9YCC	0.8	8415	
L85	OE086	RL82C	0.4	8814	
L88	OE086	RL82C	0.4	8814	
L92 N	OE086	RL82C	0.4	8814	
L93 E	OE086	RL82C	0.4	8814	
L94 TTE	OE086	RL82C	0.4	8814	
L99 E	OE086	RL82C	0.4	8814	
L99 EF	OE086	RL82C	0.4	8814	
LC88	OE086	RL82C	0.4	8814	
M1	OE037	L86C	0.4		
M1 L	OE086	RL82C	0.4	8814	
M1 PR	OE086	RL82C	0.4	8814	
M1 PRT	OE037	L86C	0.4		
M11	OE086	RL82C	0.4	8814	
M16	OE086	RL82C	0.4	8814	
M3 PRT	OE086	RL82C	0.4	8814	
M3 PRTS	OE086	RL82C	0.4	8814	
Mini-moby	OE037	L86C	0.4		
S16	OE086	RL82C	0.4	8814	
SP50	OE086	RL82C	0.4	8814	
SP7	OE086	RL82C	0.4	8814	
SP90	OE086	RL82C	0.4	8814	
SP90 R	OE086	RL82C	0.4	8814	
SP94	OE086	RL82C	0.4	8814	
Speciale 98	OE086	RL82C	0.4	8814	
Speciale TT	OE086	RL82C	0.4	8814	
SPR	OE086	RL82C	0.4	8814	
SU51	OE086	RL82C	0.4	8814	
TL7	OE086	RL82C	0.4	8814	
Trial	OE086	RL82C	0.4	8814	
Turismo	OE086	RL82C	0.4	8814	
V50	OE086	RL82C	0.4	8814	
V51	OE086	RL82C	0.4	8814	
VL50	OE086	RL82C	0.4	8814	
VLCB 51	OE086	RL82C	0.4	8814	
VSB 51	OE086	RL82C	0.4	8814	
X1	OE086	RL82C	0.4	8814	
X1 L	OE086	RL82C	0.4	8814	
X7 AVL	OE086	RL82C	0.4	8814	
X7 L	OE086	RL82C	0.4	8814	
X7 S	OE086	RL82C	0.4	8814	
X7 VX	OE086	RL82C	0.4	8814	
Z99	OE086	RL82C	0.4	8814	
75cc L NE	OE086	RL82C	0.4	8814	
80cc Enduro	OE108	RN3C	0.4	8904	
125cc	LT1 12,7mm/1/2in.	L78C	0.5	8883	
	LT1 19mm/3/4in.	OE108	RN3C	0.4	8904
	LT2 19mm/3/4in.	OE108	RN3C	0.4	8904
350cc	2 cyl. mot.	OE108	RN3C	0.4	8904
	3 cyl. mot.	OE108	RN3C	0.4	8904

MOTOBI (→ Benelli)**49cc**

	OE037	L86C	0.5	
--	--------------	------	-----	--

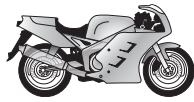
**21****POWER SPORT****MOTOBIC**

49cc All models

OE037 L86C

0.5

MOTOGAC50cc Kanowey
MTR**OE086** RL82C

0.6

8814

OE108 RN3C

0.6

8904

MOTOR HISPANIA50cc Cangurito
Cross
Dingo 49
Feria
Furia 4v
Furia 6v / Cross / Super
GT81
Jabato
M 80 Automatico
MH, MH49, MH80
Minicross
Racing RX
SL
Sport 49
Style**OE037** L86C

0.5

OE037 L86C

0.5

OE037 L86C

0.5

OE074 N5C

0.5

8339

OE091 RN2C

0.8

8904

OE091 RN2C

0.8

8904

L82C

0.5

8814

OE074 N5C

0.5

8339

OE074 N5C

0.5

8339

L82C

0.5

8814

L82C

0.5

8814

PRO-5M

OE091 RN2C

0.8

8904

OE074 N5C

0.5

8339

L82C

0.5

8814

L82C

0.5

8814

PRO-5M

MOTORI MORINI FRANCO49cc RV T4
S5-B
S5-K2,TA50**OE037** L86C

0.5

L82C

0.5

8814

OE037 L86C

0.5

50cc 3CV
3M
3M Turbo
3MK
3MS Turbo
3MV
4M
4M
4MP
4MP Turbo
4MP Turbo Special
4MR
5M
5ST Special
5ST Special
6M
6M
Convert
FM6M
G30
G30 A
G304
GSA
GSA
Gyromat
HK1
MO Kick
MO1
MO2**OE086** RL82C

0.5

8814

OE086 RL82C

0.5

8814

OE037 L86C

0.5

OE037 L86C

0.5

OE037 L86C

0.5

OE086 RL82C

0.5

8814

OE037 L86C

0.5

OE086 RL82C

0.5

8814

OE037 L86C

0.5

L77JC4

1.0

8883

OE037 L86C

0.5

OE086 RL82C

0.5

8814

OE086 RL82C

0.5

8814

OE086 RL82C

0.5

8814

OE086 RL82C

0.5

8814

L77JC4

1.0

8883

OE037 L86C

0.5

OE037 L86C

0.5

RN5C

0.5

8339

QL55

0.5

QN84

0.5

QN84

0.5

QN84

0.5

OE086 RL82C

0.5

8814

OE086 RL82C

0.5

8814

RN5C

0.5

8339

RN5C

0.5

8339

RN5C

0.5

8339

RN5C

0.5

8339

RN5C

0.5

8339

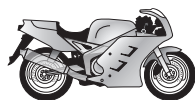
**21****POWER SPORT****...MOTORI MORINI FRANCO**

Capacity	Model	Part No.	Part No.	mm	Part No.	Part No.	
...50cc	M03		RN5C	0.5	8339		
	M04		RN5C	0.5	8339		
	M1		RN5C	0.5	8339		
	M1 ES		RN5C	0.5	8339		
	M1 K		RN5C	0.5	8339		
	M101		RN5C	0.5	8339		
	RV		OE086	RL82C	0.5	8814	
	S5		OE037	L86C	0.5		
	S5 A		OE037	L86C	0.5		
	S5 K2		OE037	L86C	0.5		
	S5 K2		OE037	L86C	0.5		
	S5 N		OE037	L86C	0.5		
	T4		OE037	L86C	0.5		
TA		OE037	L86C	0.5			
80cc	6.8		OE037	L86C	0.5		
	TS		OE037	L86C	0.5		
100cc	N 32 101 19mm/3/4in.		OE108	RN3C	0.5	8904	
	New 19mm/3/4in.		OE108	RN3C	0.5	8904	
	New Sport 12,7mm/1/2in.		OE086	RL82C	0.5	8814	
125cc	FM Twin			L78C	0.5	8883	
	GT		OE108	RN3C	0.6	8904	
	S		OE108	RN3C	0.6	8904	
	Strada		OE108	RN3C	0.6	8904	
	Trial		OE004	RN9YCC	0.8	8415	
175cc	M03, M1, M1S		OE074	N5C	0.5	8339	
	N1K		OE074	N5C	0.5	8339	

MOTOTECHNIKA

45cc	Motovelosiped 1989		OE007	L87YC	0.7		
50cc	Karpati		OE007	L87YC	0.6		
	Mokick		OE038	L82YC	0.7	8814	
	Riga		OE007	L87YC	0.6		
	Tricycle ZID-50 1998		OE038	L82YC	0.6	8814	
	Turist		OE007	L87YC	0.6		
	Veachowina		OE007	L87YC	0.6		
	Veterok		OE007	L87YC	0.6		

MTK

50cc	Formula		OE037	L86C	0.5		
	Pony		OE037	L86C	0.5		
	Sport		OE037	L86C	0.5		

1000cc	E-54 Competition: J, P, S			C55R	0.5		
--------	---------------------------	--	--	------	-----	--	--

MTV

50cc	Cross		OE001	N9YC	0.5	8415	
	Sport		OE001	N9YC	0.5	8415	

MÜNCH

1000cc	Mammut TTS	→1982	OE087	N6YC	0.5	8902	
1200cc	Mammut TS	→1982	OE087	N6YC	0.5	8902	
	TS / TTS-E	→1982	OE087	N6YC	0.5	8902	

MUSTANG

	Cross Special		OE086	RL82C	0.5	8814	
	Mamba		OE086	RL82C	0.5	8814	
	TT Super		OE086	RL82C	0.5	8814	

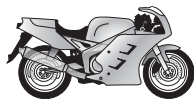
**21****POWER SPORT****MV AGUSTA**

350cc	B GT / S / Scrambler		OE068	N3C	0.5	8904	
	BE GT (216)		OE068	N3C	0.5	8904	
	BE GT / S / Scrambler		OE068	N3C	0.5	8904	
	BES (216)		OE068	N3C	0.5	8904	
	GT Electronique		OE068	N3C	0.5	8904	
	S Electronique		OE068	N3C	0.5	8904	
	Scrambler Electronique		OE068	N3C	0.5	8904	
	Sport	→1980	OE068	N3C	0.5	8904	
600cc	199,4C6		OE068	N3C	0.5	8904	
750cc	4C75S / GT / S / SS		OE068	N3C	0.5	8904	
	F4 Ago	2003 →	OE092	RG4HC	0.7	8698	
	F4 Brutale	1999 →	OE092	RG4HC	0.7	8698	
	F4 Brutale S	2002 →	OE092	RG4HC	0.7	8698	
	F4 Oro	1999 →	OE092	RG4HC	0.7	8698	
	F4 S	2003 →	OE092	RG4HC	0.7	8698	
	F4 S SPR	1999 →	OE092	RG4HC	0.7	8698	
	F4 Senna	1999 →	OE092	RG4HC	0.7	8698	
	S American		OE079	N4C	0.5	8339	
	S4	1998 →	OE092	RG4HC	0.7	8698	
800cc	S	→1980	OE079	N4C	0.5	8339	
900cc	S	→1980	OE079	N4C	0.5	8339	
910cc	Brutale	2005 →	OE092	RG4HC	0.7	8698	
	Brutale R	2006 →	OE092	RG4HC	0.7	8698	
	Brutale S	2005 →	OE092	RG4HC	0.7	8698	
1000cc	F4 1000 1+1	2005 →		G54V			
	F4 1000 S	2004 →	OE092	RG4HC	0.6	8698	
	F4 1000 Senna	2006 →		G54V			
	F4 1000 Tamburini	2004 →2005	OE092	RG4HC	0.6	8698	
MZ							
50cc	S B Simson			L82C	0.5	8814	
	S51		OE037	L86C	0.5		
	S51 Comfort, Swift		OE037	L86C	0.5		
70cc	S Comfort, S70			L82C	0.5	8814	
125cc	Cup Replica SM	2005 →		RG94C	0.6	8698	
	ES 1 Trophy			L82C	0.5	8814	
	ETZ			L82C	0.5	8814	PRO-5M
	Fun X	2001 →		RG94C	0.6	8698	
	Gangsta SM	2005 →		RG94C	0.6	8698	
	Luxus			L82C	0.5	8814	
	RT	2000 →		RG94C	0.6	8698	
	RT Classic	2003 →		RG94C	0.6	8698	
	RT SM	2000 →		RG94C	0.6	8698	
	Saxon Roadstar	1993 →		L78C	0.5	8883	PRO-5M
	Saxon Sportstar	1993 →		L78C	0.5	8883	PRO-5M
	SM	2001 →		RG94C	0.6	8698	
	Striker RT	2005 →		RG94C	0.6	8698	
	Supermoto	2005 →		RG94C	0.6	8698	
	SX	2001 →		RG94C	0.6	8698	
	TS Alpine			L82C	0.5	8814	
	Twin Colour SM	2006 →		RG94C	0.6	8698	
	Youngster Cup	2003 →		RG94C	0.6	8698	

**MZ**

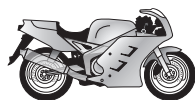
**21****POWER SPORT****...MZ**

150cc	ES 1 Trophy, Super		L82C	0.5	8814	PRO-5M
	ETS ,Trophy-Sport		L78C	0.5	8883	PRO-5M
	ETZ		L78C	0.5	8883	PRO-5M
	Saxon Roadstar		L78C	0.5	8883	PRO-5M
	Saxon Sportstar		L78C	0.5	8883	PRO-5M
	TS ,Eagle, Sport		L78C	0.5	8883	PRO-5M
175cc	ES 2 Trophy		L78C	0.5	8883	PRO-5M
250cc	ES2 502 Trophy		L82C	0.5	8814	PRO-5M
	ES2 502 Trophy Deluxe		L82C	0.5	8814	PRO-5M
	ETS I.G.		L78C	0.5	8883	
	ETS Trophy-Sport		L78C	0.5	8883	
	ETZ Classic		L78C	0.5	8883	PRO-5M
	Saxon Fun		L78C	0.5	8883	PRO-5M
	Saxon Tour		L78C	0.5	8883	PRO-5M
	TS, Sport		L78C	0.5	8883	PRO-5M
	TS2 501 Supa 5		L78C	0.5	8883	PRO-5M
301cc	ETZ Classic	1990 →	L78C	0.5	8883	PRO-5M
	Saxon Fun		L78C	0.5	8883	PRO-5M
	Saxon Tour		L78C	0.5	8883	PRO-5M
500cc	Green Star 500 (Mot.Rotax)	1996 →2000	OE083 RA6HC		8809	
	MZ		OE083 RA6HC	0.5	8809	
	Red Star 500 (Mot.Rotax)	1996 →2000	OE083 RA6HC		8809	
	Saxon Country		OE083 RA6HC	0.7	8809	
	Saxon Fun		OE083 RA6HC	0.7	8809	
	Saxon Funkkrad		OE083 RA6HC	0.7	8809	
	Saxon Tour		OE083 RA6HC	0.7	8809	
	Saxon Voyager		OE083 RA6HC	0.7	8809	
	Silver Star Classic		OE083 RA6HC	0.7	8809	
	Silver Star Gespann	1995 →	OE083 RA6HC	0.7	8809	
660cc	Baghira	1997 →	RAX92YC	0.9	8809	
	Baghira Black Panther	1999 →	RAX92YC	0.9	8809	
	Baghira Black Panther HR	2000 →	RAX92YC	0.9	8809	
	Baghira Forest	1999 →	RAX92YC	0.9	8809	
	Baghira HR	1999 →	RAX92YC	0.9	8809	
	Baghira Street Moto	1999 →	RAX92YC	0.9	8809	
	Baghira Street Moto HR	2000 →	RAX92YC	0.9	8809	
	Mastiff	1997 →	RAX92YC	0.9	8809	
	Replica	1995 →	RAX92YC	0.9	8809	
	Skorpion	1994 →	RAX92YC	0.9	8809	
	Skorpion Cup	1996 →	RAX92YC	0.9	8809	
	Skorpion Replica	1995 →	RAX92YC	0.9	8809	
	Skorpion Sport	1994 →	RAX92YC	0.9	8809	
	Skorpion Tour	1994 →	RAX92YC	0.9	8809	
	Skorpion Traveller	1996 →	RAX92YC	0.9	8809	
	Supermoto	2005 →	RAX92YC	0.9	8809	
850cc	Kobra	1995 →	RAX92YC	0.9	8809	
1000cc	S	2004 →	OE021 RC7BMC	0.8		
	SF	2005 →	OE021 RC7BMC	0.8		
	ST	2005 →	OE021 RC7BMC	0.8		

NEGRINI

50cc	Harvard		RN5C	0.5	8339	
-------------	---------	--	------	-----	------	--

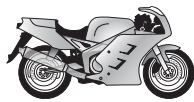
**21****POWER
SPORT****NEVAL**

125cc	Commuter		OE086	RL82C	0.5	8814	
	Elt		OE086	RL82C	0.5	8814	
	Elt		OE086	RL82C	0.5	8814	
	Elt Sports		OE086	RL82C	0.5	8814	
	Scrambler		OE086	RL82C	0.5	8814	
	Trial		OE086	RL82C	0.5	8814	
150cc	All models		OE086	RL82C	0.5	8814	
250cc	All models		OE086	RL82C	0.5	8814	
350cc	All models		OE086	RL82C	0.5	8814	
649cc	Soviet Knight (Air cooled)			L82C	0.6	8814	
650cc	Dnieper		OE086	RL82C	0.5	8814	
	Soviet (Air cooled)			L82C	0.6	8814	
750cc	SV MT12		OE086	RL82C	0.5	8814	

NORTON

500cc	Dominator 7 Alum head		OE074	N5C	0.5	8339	
	Dominator 7 Iron head			L82C	0.5	8814	
	Dominator 88 Alum head		OE074	N5C	0.5	8339	
	Dominator 88 Iron head			L82C	0.5	8814	
	ES2		OE074	N5C	0.5	8339	
	ES2 Iron head			L82C	0.5	8814	
588cc	Classic (Liquid cooled) (Rotary engine)	1987→1988		G59C	0.6	8698	
	Commander (Liquid cooled) (Rotary engine)	1988→1994		G59C	0.6	8698	
	F1 (Liquid cooled) (Rotary engine)	1990→1992		G59C	0.6	8698	
600cc	Dominator		OE074	N5C	0.5	8339	
	Dominator 99 Alum head		OE074	N5C	0.5	8339	
650cc	C 652 SM (F650)	1999→	OE083	RA6HC	0.6	8809	
	Manxman		OE010	N7YC	0.6	8332	
	Mercury		OE010	N7YC	0.6	8332	
745cc	Atlas		OE084	N6YCC	0.6	8902	
	Ranger P11A		OE084	N6YCC	0.6	8902	
750cc	Commando Fastback		OE010	N7YC	0.8	8332	
	Commando Fastback		OE084	N6YCC	0.6	8902	
	Commando S, Roadster		OE010	N7YC	0.8	8332	
	Commando S, Roadster		OE084	N6YCC	0.6	8902	
850cc	Commando		OE010	N7YC	0.8	8332	
	G15		OE010	N7YC	0.8	8332	
	P11		OE010	N7YC	0.8	8332	
	Ranger		OE010	N7YC	0.8	8332	

NSU

50cc	Quick	1962→	OE037	L86C	0.5		
	Quickly F23	1963→	OE037	L86C	0.5		
	Quickly N / N23	1963→	OE037	L86C	0.5		
	Quickly S	→1963	OE037	L86C	0.5		
	Quickly S / 2	1962→	OE037	L86C	0.5		
	Quickly S 23	1962→	OE037	L86C	0.5		
	Quickly T	→1964	OE037	L86C	0.5		
	Quickly TT	→1961	OE037	L86C	0.5		
	Quickly TTK	1962→	OE037	L86C	0.5		
125cc	125 ZDB			L82C	0.5	8814	
	Fox 2 stroke			L78C	0.5	8883	
	Fox 4 stroke			L82C	0.5	8814	
	Super Fox			L78C	0.5	8883	

**NSU**

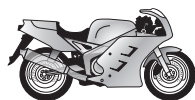
**21****POWER
SPORT****...NSU**

150cc	Prima 3	1958 → 1961	OE037	L86C	0.5	
	Prima 3K	1958 → 1961	OE037	L86C	0.5	
	Prima 3KL	1958 → 1961	OE037	L86C	0.5	
175cc	Maxi	1957 → 1961	OE037	L86C	0.5	
	Prima 5	1957 → 1961	OE037	L86C	0.5	
200cc	Lux			L82C	0.5	8814
	Super Lux			L78C	0.5	8883
250cc	Max	1955 → 1958		L78C	0.5	8883
	Super Max	1959 → 1961	OE037	L86C	0.5	
	Supermax	1956 →		L78C	0.5	8883
350cc	Konsul 1			L82C	0.5	8814
500cc	Konsul 2			L82C	0.5	8814
	Konsul Sport			L78C	0.5	8883

NVT

500cc	Easy Rider			RN5C	0.5	8339
	Rambler 125		OE108	RN3C	0.6	8904
	Rambler 175		OE108	RN3C	0.6	8904
	Ranger			RN5C	0.5	8339

OGLAND

500cc	MA 502 (Sachs mot.)		OE037	L86C	0.5	
	MA 503 (Sachs mot.)		OE037	L86C	0.5	

OMER

50cc	Cross Mini		OE037	L86C	0.6	
	Daytona 8 Mini		OE037	L86C	0.6	
	Maggiolino		OE037	L86C	0.5	
	Maggiolione		OE037	L86C	0.5	
	Tanga / Noleggiato		OE037	L86C	0.6	
	Vallelunga 10		OE037	L86C	0.6	
	Vivo		OE001	N9YC	0.6	8415

OSSA

50cc	Ossita		OE037	L86C	0.5	
125cc	Enduro / Super Pioneer		OE087	N6YC	0.5	8902
	Moto Cross / Phantom		OE040	N2C	0.5	8904
150cc	Phantom		OE068	N3C	0.5	8904
160cc	GT-T2		OE079	N4C	0.5	8339
175cc	American / Enduro / Sport		OE068	N3C	0.5	8904
	Moto Cross / Phantom		OE040	N2C	0.5	8904
	Super Pioneer/ 6 Dias		OE068	N3C	0.5	8904
230cc	Explorer / Trial		OE001	N9YC	0.5	8415
	Super Pioneer		OE068	N3C	0.5	8904
250cc	American Enduro / Copa		OE040	N2C	0.5	8904
	Copa F3		OE125	N2G	0.5	8904
	Desert / Enduro / Moto Cross		OE040	N2C	0.5	8904
	Desert, Phantom, S.Pioneer		OE040	N2C	0.5	8904
	M.A.R. Explorer / Trial		OE001	N9YC	0.5	8415
	Sport/Super Pioneer,TE		OE040	N2C	0.5	8904
	T, Copa, F3		OE040	N2C	0.5	8904
	TR 80, Exp. / Trial / Tu-yo		OE001	N9YC	0.5	8415
	Urbe Phantom, Trofeo E7		OE040	N2C	0.5	8904
350cc	303 Trial, TR 80,		OE001	N9YC	0.5	8415
	Desert / Super Pioneer		OE068	N3C	0.5	8904
	Explorer / Tu-yo , Trail		OE001	N9YC	0.5	8415
500cc	S, Yankee		OE068	N3C	0.5	8904

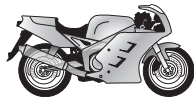
**21****POWER SPORT****PENTON**

100cc	Berkshire Enduro KTM		L78C	0.5	8883	
	Enduro KTM		L78C	0.5	8883	
125cc	Six-day Enduro KTM		L78C	0.5	8883	
	Six-day KTM		L78C	0.5	8883	

PEUGEOT

50cc	101		OE037	L86C	0.5		PRO-5M
	102		OE037	L86C	0.5		PRO-5M
	103	1975 →	OE037	L86C	0.5		PRO-5M
	104		OE037	L86C	0.5		PRO-5M
	105		OE037	L86C	0.5		PRO-5M
	102 MV / MVL			L82C	0.5	8814	PRO-5M
	103 CRX			L78C	0.5	8883	PRO-5M
	103 LC		OE068	N3C	0.5	8904	PRO-5M
	103 LSM-D		OE037	L86C	0.5		PRO-5M
	103 MP / MR			L78C	0.5	8883	PRO-5M
	103 MV / MVL			L82C	0.5	8814	PRO-5M
	103 Racing			L78C	0.5	8883	PRO-5M
	103 SP	1986 →		L78C	0.5	8883	PRO-5M
	103 SPM-D		OE037	L86C	0.5		PRO-5M
	103 T16			L78C	0.5	8883	PRO-5M
	103 TXLC / TXR		OE068	N3C	0.5	8904	PRO-5M
	103 Vogue			L78C	0.5	8883	PRO-5M
	103 XP / XPLC		OE068	N3C	0.5	8904	PRO-5M
	103 Z			L82C	0.5	8814	PRO-5M
	BB3K		OE037	L86C	0.5		
	BB3L		OE037	L86C	0.5		
	BB3SP		OE037	L86C	0.5		
	C		OE037	L86C	0.5		
	Fox	1997 →		L82C	0.5	8814	
	GL10		OE037	L86C	0.5		
	GT10 F3		OE037	L86C	0.5		PRO-5M
	Metropolis Scooter		OE037	L86C	0.5		
	MVL	1997 →		L82C	0.5	8814	
	P80			L78C	0.5	8883	
	RCX	1997 →	OE086	RL82C	0.5	8814	
	RCX LC	1997 →	OE086	RL82C	0.5	8814	
	RS		OE037	L86C	0.5		
	RT		OE037	L86C	0.5		
S157		OE037	L86C	0.5			
S55		OE037	L86C	0.5			
SC		OE037	L86C	0.5			
SC L		OE037	L86C	0.5			
SC L (I)		OE064	RL82YC	0.6	8814		
Scoper V		OE037	L86C	0.5			
Speedah	1997 →		L82C	0.5	8814		
SPX	1997 →		L82C	0.5	8814		
STL 2			RL86C	0.5			
SX		OE037	L86C	0.5			
SX5		OE037	L86C	0.5		PRO-5M	
TLX			L82C	0.5	8814	PRO-5M	
TSA		OE037	L86C	0.5			
TXLC		OE108	RN3C	0.5	8904		
TXR		OE108	RN3C	0.5	8904		
Velo			L78C	0.5	8883		

**PEUGEOT**

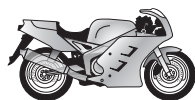
**21****POWER SPORT****...PEUGEOT**

...50cc	VOG	1997 →	OE086	RL82C	0.5	8814	
	X LC			QC57C	0.5		
	XP		OE108	RN3C	0.5	8904	
	XPLC		OE108	RN3C	0.5	8904	
80cc	SC L		OE086	RL82C	0.5	8814	PRO-5M
	SX T	1978 →1982	OE086	RL82C	0.5	8814	PRO-5M
100cc	5-52-53		OE037	L86C	0.5		PRO-5M
	P51-53			J8C	0.5		
125cc	550		OE037	L86C	0.5		
	55 C		OE037	L86C	0.5		
	55 D		OE037	L86C	0.5		
150cc	P			L82C	0.5	8814	
155cc	P			L82C	0.5	8814	
	P 156			L82C	0.5	8814	
175cc	176			L82C	0.5	8814	
	176 BB			L82C	0.5	8814	
	176 Grand Sport		OE074	N5C	0.5	8339	
	176 TC			L82C	0.5	8814	
250cc	256			L82C	0.5	8814	

PIAGGIO / VESPA

998cc	Porter (Commercial)		OE004	RN9YCC	0.7	8415	
	Porter (Commercial)		OE004	RN9YCC	0.7	8415	

PLANET

cc	Cossack		OE037	L86C	0.5		
-----------	---------	--	--------------	------	-----	--	--

POLINI

50cc	Steel 910 LC Pocket Bike		OE037	L86C	0.5		
	Steel 910 LC Race Pocket Bike		OE037	L86C	0.5		
	Steel 910 Pocket Bike		OE037	L86C	0.5		
	Steel 910 Race Pocket Bike		OE037	L86C	0.5		

PREMIER BEBE

	Mini-Bikes		OE086	RL82C	0.8	8814	
--	------------	--	--------------	-------	-----	------	--

PROMOT

125cc	All models		OE037	L86C	0.6		
--------------	------------	--	--------------	------	-----	--	--

PUCH

49cc	Borrasca		OE086	RL82C	0.5	8814	
	Caribe		OE037	L86C	0.5		
	Condor , III, MD		OE086	RL82C	0.5	8814	
	Magnum		OE086	RL82C	0.5	8814	
	Maxi		OE086	RL82C	0.5	8814	
	Minicross		OE086	RL82C	0.5	8814	
	Monza		OE086	RL82C	0.5	8814	
	Voy		OE037	L86C	0.5		
	X10		OE037	L86C	0.5		
	X20		OE037	L86C	0.5		
	X30		OE037	L86C	0.5		
	X30 Cross		OE037	L86C	0.5		
	X40		OE037	L86C	0.5		

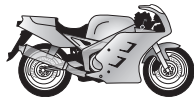
**21****POWER
SPORT****...PUCH****50cc**

Cobra 6GT		L78C	0.5	8883	PRO-5M
DS 50 - / K / KXN / RN	OE037	L86C	0.5		
DS 60 C / CN / R / RN	OE037	L86C	0.5		
Grand Prix		L78C	0.5	8883	
GS		L77JC4	0.5	8883	
GT		L77JC4	0.5	8883	
GTL		L77JC4	0.5	8883	
M Jet		L78C	0.5	8883	
M Racing	OE037	L86C	0.5		
M SE		L78C	0.5	8883	
M Sport	OE037	L86C	0.5		
Maxi		L90C	0.5		
Maxi II	OE037	L86C	0.5		
Maxi II 25		L90C	0.5		
Maxi N	OE037	L86C	0.5		
Maxi Plus G		L90C	0.6		
Maxi S		L90C	0.5		
MC 60 Scrambler		L78C	0.5	8883	
Mini Maxi		L90C	0.6		
Mofa Maxi D S O	OE037	L86C	0.5		
Mofa Maxi K		RH12	0.5		
Mofa Maxi L F A Z G	OE037	L86C	0.5		
Mofa Maxi X30, X50-2, X50-3	OE037	L86C	0.5		
Monza		L78C	0.5	8883	
Monza 4SL	OE037	L86C	0.5		
Monza 4SL KIT	OE037	L86C	0.5		
Monza 6SL		L78C	0.5	8883	
MS 25	OE037	L86C	0.5		
MS California	OE037	L86C	0.5		
MS De Luxe Sears	OE037	L86C	0.5		
MS L	OE037	L86C	0.5		
MS Sears	OE037	L86C	0.5		
MS V / Autolec	OE037	L86C	0.5		
P 1 L / XL		L90C	0.5		
Pioner K	OE037	L86C	0.5		
R - / K / R / V	OE037	L86C	0.5		
R M		L78C	0.5	8883	
Ranger A D	OE037	L86C	0.5		
SDR		L78C	0.5	8883	
Special		L78C	0.5	8883	
Supreme		L78C	0.5	8883	
U2	OE037	L86C	0.5		
US 4	OE037	L86C	0.5		
VS 60 R	OE037	L86C	0.5		
VS D / DK / DS / L / Autolec / R	OE037	L86C	0.5		
VZ 4 / K / R / V	OE037	L86C	0.5		
VZ 60 R	OE037	L86C	0.5		
VZ M		L78C	0.5	8883	
X 30	OE037	L86C	0.5		
X 50-3		L82C	0.5	8814	

**PUCH**

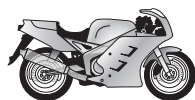
**21****POWER SPORT****...PUCH**

75cc	74M 82FD		OE091	RN2C	0.5	8904	
	Agua		OE091	RN2C	0.5	8904	
	Cobra 12,7mm/1/2in.			QL55	0.5		PRO-5M
	Cobra 19mm/3/4in.		OE091	RN2C	0.5	8904	PRO-5M
	GS			QL55	0.5		
80cc	Cobra 12,7mm/1/2in.	1981 →		L77JC4	0.6	8883	
	Cobra 19mm/3/4in.	1981 →	OE040	N2C	0.6	8904	
125cc	GS		OE040	N2C	0.5	8904	PRO-5M
	M 12,7mm / 1/2in.			L82C	0.6	8814	PRO-5M
	M 19mm/3/4in.		OE068	N3C	0.5	8904	PRO-5M
	MC		OE040	N2C	0.6	8904	
	MC S		OE068	N3C	0.5	8904	
	RL		OE037	L86C	0.6		
	Trial		OE068	N3C	0.5	8904	
175cc	MC		OE040	N2C	0.6	8904	
250cc	17C		OE040	N2C	0.6	8904	
	F3		OE040	N2C	0.6	8904	
	GS		OE068	N3C	0.5	8904	
	GS FS		OE040	N2C	0.6	8904	
	MC		OE040	N2C	0.6	8904	
350cc	GS		OE040	N2C	0.6	8904	
	GS F4T			QN84	0.6		
	GS HW			QN84	0.6		
366cc	GS		OE068	N3C	0.5	8904	
500cc	GS			RAX92YC	0.9	8809	
	GS MC436	1980 →		RAX92YC	0.9	8809	
	MC		OE125	N2G	0.6	8904	
560cc	GS			RAX92YC	0.9	8809	
	GS F4T			RAX92YC	0.9	8809	
	GS F4T 504			RAX92YC	0.9	8809	
	Mini-Bikes		OE086	RL82C	0.8	8814	

QINGQI

125cc	CG125			P-RA7HC		8812	
139cc	139QMB			P-RZ9HC			
	GS139			P-RZ9HC			
150cc	CG150			P-RA7HC		8812	
	GS2			P-RG7C			

RABBIT

49cc	All models 12,7mm/1/2in.			RJ6C	0.5		
	All models 9.5mm/3/8 in.		OE037	L86C	0.5		

RCA

350cc	2 cyl. mot.		OE037	L86C	0.5		
--------------	-------------	--	--------------	------	-----	--	--

REGENT

125cc	Roadster De-luxe (Air cooled)	1996 →	OE037	L86C	0.6		
	Roadster Super (Air cooled)	1996 →	OE037	L86C	0.6		
	RT (Air cooled)	1996 →	OE037	L86C	0.6		
	Tourer (Air cooled)	1996 →	OE037	L86C	0.6		
175cc	Roadster De-luxe (Air cooled)	1996 →	OE037	L86C	0.6		
	Roadster Super (Air cooled)	1996 →	OE037	L86C	0.6		
	RT (Air cooled)	1996 →	OE037	L86C	0.6		
	Tourer (Air cooled)	1996 →	OE037	L86C	0.6		

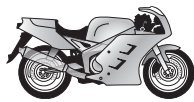
**21****POWER
SPORT****REX**

50cc	MA502 (Sachs mot.)		OE037	L86C	0.5	
	MA503 (Sachs mot.)		OE037	L86C	0.5	
	MA504 (Sachs mot.)		OE037	L86C	0.5	
125cc	Chopper		OE083	RA6HC	0.7	8809
	Cruiser		OE083	RA6HC	0.7	8809
	Fun Bike	2000 →	OE132	A6HC	0.9	8809

RIEJU

50cc	Confort 402			L82C	0.5	8814
	Confort 403			L82C	0.5	8814
	Confort 501		OE037	L86C	0.5	
	GT / GT Sport 49		OE079	N4C	0.5	8339
	GT404			L82C	0.5	8814
	GT505		OE079	N4C	0.5	8339
	GT505 R			L82C	0.5	8814
	Helios		OE037	L86C	0.5	
	KS Automatic		OE037	L86C	0.5	
	Marathon		OE079	N4C	0.5	8339
	Marathon Super / FDN / MT		OE079	N4C	0.5	8339
	Pony			L82C	0.5	8814
	RV		OE079	N4C	0.5	8339
	Spike	2003 →	OE108	RN3C	0.7	8904
	Sprint			L82C	0.5	8814
	Strada		OE079	N4C	0.5	8339
	Supermotard	2000 →	OE108	RN3C	0.7	8904
TT404			L82C	0.5	8814	
TT504			L82C	0.5	8814	
TT505 R		OE079	N4C	0.5	8339	
Varimat		OE037	L86C	0.5		
75cc	Marathon 74TT / Enduro		OE074	N5C	0.5	8339
	Marathon Cross		OE125	N2G	0.5	8904
	Marathon Enduro		OE125	N2G	0.5	8904
	MR 74 E		OE079	N4C	0.5	8339
	RS1		OE079	N4C	0.5	8339
	RST		OE079	N4C	0.5	8339
	Strada GT		OE079	N4C	0.5	8339
	TT406		OE037	L86C	0.5	
80cc	MR 80 E		OE079	N4C	0.5	8339
	MR Enduro / Cross		OE125	N2G	0.5	8904
	RST		OE079	N4C	0.5	8339
RIERA						
50cc	Windy		OE086	RL82C	0.5	8814
RIXE						
50cc	Champion FT / FTH		OE037	L86C	0.6	
	Derby B			L82C	0.5	8814
	Derby D			L78C	0.5	8883
	Geschäftsmoped			L82C	0.5	8814
	Hight Sport		OE037	L86C	0.6	
	Libelle E21			L90C	0.5	
	Libelle E23			L90C	0.5	
	Libelle FT/FTH/GTH		OE037	L86C	0.6	
	Libelle Hight Sport Super			L90C	0.5	
	R503		OE037	L86C	0.6	
	R504			L82C	0.5	8814

**RIXE**

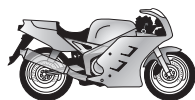
**21****POWER
SPORT****...RIXE****...50cc**

RS50 B3/ B4	OE037	L86C	0.6	
RS50S		L78C	0.5	8883
Standard 7 h		L82C	0.5	8814
Turismo 4		L82C	0.5	8814
Turismo E21	OE037	L86C	0.6	
Turismo ELS	OE037	L86C	0.6	
Turismo SL40	OE037	L86C	0.6	

RIZZATO**50cc**

112 4M	OE037	L86C	0.5	
118 4M	OE037	L86C	0.5	
Atala Uno, Master, Green	OE037	L86C	0.5	
Califfo matic 121	OE037	L86C	0.5	
Califfo Monomarcia Super	OE037	L86C	0.5	
Califfo Super, 80, De Luxe, K, Gio, 119	OE037	L86C	0.5	
Califfone 4M	OE037	L86C	0.5	
Cross		L82C	0.5	8814
Cross	OE037	L86C	0.5	
Daytona	OE037	L86C	0.5	
Mini Califfo	OE037	L86C	0.5	
Mirage P4	OE037	L86C	0.5	
Piu	OE037	L86C	0.5	
Pullman	OE037	L86C	0.5	
Ringo	OE037	L86C	0.5	
Satan 4M / Cross Satan 71	OE037	L86C	0.5	
Super Luxe 73		L82C	0.5	8814
Super Sprint / Mirage		L82C	0.5	8814
Turismo Monomarcia		L82C	0.5	8814
Zum 3 4M	OE037	L86C	0.5	

80cc

118 Competizione	OE068	N3C	0.5	8904
------------------	--------------	-----	-----	------

125cc

Cross Coguaro	OE037	L86C	0.5	
Turismo	OE037	L86C	0.5	

ROYAL ENFIELD**50cc**

Bonny	OE037	L86C		
Sunny	OE037	L86C		

100cc

KB	OE040	N2C		8904
----	--------------	-----	--	------

150cc

Ensign , RE, Prince		L90C	0.5	
---------------------	--	------	-----	--

197cc

Fantabulus		L82C	0.5	8814
------------	--	------	-----	------

250cc

Clipper, Crusader, J2, Olympic	OE037	L86C	0.5	
Continental, GT, Turbo Twin		L82C	0.5	8814
Scrambler		C55	0.4	

350cc

Bullet	1980 →	L82C	0.5	8814
Bullet (12,7mm, 1/2in)		OE037	L86C	0.5
Bullet (19mm, 3/4in)		OE074	N5C	0.5
De Luxe (12,7mm, 1/2in)		RL86C	0.6	
De Luxe (19mm, 3/4in)		RN5C	0.6	8339
India		L82C	0.5	8814
Super Star (12,7mm, 1/2in)		RL86C	0.6	
Super Star (19mm, 3/4in)		RN5C	0.6	8339
Thunderbird	1980 →	L82C	0.5	8814
Thunderbird Twinspark 16mm	2008 →	RG6YC		
Thunderbird Twinspark 21mm	2008 →	OE087	N6YC	8902

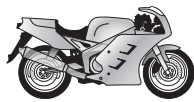
**21****POWER
SPORT****...ROYAL ENFIELD**

500cc	Bullet	1980 →	OE068	N3C	0.5	8904
	Bullet (12,7mm,1/2in)		OE037	L86C	0.5	
	Bullet (19mm,3/4in)		OE074	N5C	0.5	8339
	Bullet Army	1980 →	OE068	N3C	0.5	8904
	Bullet Classic EFI Twinspark 16mm	2009 →		RG6YC		
	Bullet Classic EFI Twinspark 21mm	2009 →	OE087	N6YC		8902
	Bullet De Luxe	1980 →	OE068	N3C	0.5	8904
	Bullet Electra	1980 →	OE068	N3C	0.5	8904
	Bullet Electra X (Lean Burn)	2004 →	OE091	RN2C	0.8	8904
	Bullet Sixty 5	1980 →	OE068	N3C	0.5	8904
	India		OE068	N3C	0.5	8904
	Meteor Minor (12,7mm,1/2in)		OE037	L86C	0.5	
	Meteor Minor (19mm,3/4in)		OE074	N5C	0.5	8339
	700cc	Constellation		OE074	N5C	0.5
Meteor Twin			OE037	L86C	0.5	
Super Meteor (12,7mm,1/2in)			OE037	L86C	0.5	
Super Meteor (19mm,3/4in)			OE074	N5C	0.5	8339
750cc	Interceptor		OE079	N4C	0.5	8339

SACHS

30cc	Saxonette	1987 →		RJ18YC	0.5	
	Saxonette Classic			RJ14YC	0.5	
50cc	City Bike C1	1972 →1978	OE037	L86C	0.7	
	City Bike C2	1972 →1978	OE037	L86C	0.7	
	City Bike C3	1974 →1978	OE037	L86C	0.7	
	Dirty Devil		OE059	L92YC	0.5	
	Enduro ZX		OE108	RN3C	0.5	8904
	Hobby Rider HR 1	1972 →1987	OE037	L86C	0.7	
	Hobby Rider HR 2	1972 →1987	OE037	L86C	0.7	
	Jogging		OE037	L86C	0.5	
	K	→1978		L78C	0.7	8883
	K Ultra	→1978		L78C	0.7	8883
	K Ultra II	→1978		L78C	0.5	8883
	K Ultra LC	→1978	OE040	N2C	0.5	8904
	K Ultra LC II	→1978	OE040	N2C	0.5	8904
	K Ultra LC III	→1978	OE040	N2C	0.5	8904
	KX		OE037	L86C	0.5	
	KX 5	1986 →	OE038	L82YC	0.5	8814
	Lastboy			L82C	0.5	8814
	M1	1972 →1977	OE037	L86C	0.5	
	M2	1972 →1977	OE037	L86C	0.5	
	M4	1974 →1978	OE037	L86C	0.5	
	M5	1974 →1978	OE037	L86C	0.5	
	MK 1S	1978 →1980	OE037	L86C	0.5	
	MK 2S	1978 →1980	OE037	L86C	0.5	
	MP 2	1972 →1977	OE037	L86C	0.5	
	MP 4	1972 →1977	OE037	L86C	0.5	
	MX 1	1989 →	OE037	L86C	0.5	
	MX 1		OE037	L86C	0.5	
Optima			RL78C	0.5	8883	
Optima	1995 →		RL78C		8883	
Optima 3	1978 →	OE037	L86C	0.5		
Prima 2			RL86C	0.5		
Prima 2S	1989 →	OE037	L86C	0.5		

**SACHS**

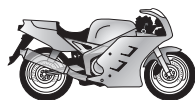
**21****POWER
SPORT****...SACHS****...50cc**

Prima 3		OE037	L86C	0.5		
Prima 3S	1989 →	OE037	L86C	0.5		
Prima 4		OE037	L86C	0.5		
Prima 4LN,5LN		OE037	L86C	0.5		
Prima 5		OE037	L86C	0.5		
Prima 5,5S	1989 →		RL86C	0.5		
Prima 6		OE037	L86C	0.5		
Prima G3		OE037	L86C	0.5		
Prima GT	1989 →	OE037	L86C	0.5		
Prima GT,GX		OE037	L86C	0.5		
Prima Presto		OE037	L86C	0.5		
Prima Pronto		OE037	L86C	0.5		
Prima S		OE037	L86C	0.5		
Prima SL		OE037	L86C	0.5		
Prima SX		OE037	L86C	0.5		
Sport Bike SB1	1972 →1974		L78C	0.5	8883	
Sport Bike SB2	1972 →1979	OE037	L86C	0.5		
Sport Bike SB3	1974 →1979	OE037	L86C	0.5		
Sport Bike SB5	1974 →1976		L78C	0.5	8883	
Supra 2D,3D	1980 →	OE037	L86C	0.5		
Supra 4	1978 →		L82C	0.5	8814	
Supra 4GP	1980 →	OE037	L86C	0.5		
Supra Enduro	1980 →	OE037	L86C	0.5		
Ultra		OE040	N2C	0.5	8904	
XE 5	1986 →	OE038	L82YC	0.5	8814	
ZX 1		OE079	N4C	0.5	8339	

80cc

RX 9			L78C	0.5	8883	
Samba SR Roller			L78C	0.6	8883	
Ultra AC	1982 →		L82C	0.5	8814	
Ultra LC			L78C	0.5	8883	
XE 9	1982 →		L78C	0.5	8883	

100cc

K X			L78C	0.5	8883	
-----	--	--	------	-----	-------------	--

110cc

Dirty Devil			Z9Y	0.6		
-------------	--	--	-----	-----	--	--

125cc

K BW Military	1974 →		L78C	0.5	8883	
K GS		OE040	N2C	0.5	8904	
K MC		OE040	N2C	0.5	8904	
K S	1972 →1979	OE125	N2G	0.5	8904	
K T	1972 →1979	OE125	N2G	0.5	8904	
K X			L78C	0.5	8883	
MadAss			RZ96C	0.8		
Roadster (Air cooled)	2000 →		P-RZ9HC	0.7		
Roadster V2	1998 →		P-RZ9HC	0.8		
RS	1997 →	OE108	RN3C	0.7	8904	PRO-5M
X-Road			RG94C	0.6	8698	
XTC Racing (Liquid cooled)	2000 →	OE108	RN3C	0.7	8904	
XTC V2	1998 →	OE091	RN2C	0.8	8904	
XTC-N V2	1998 →	OE108	RN3C	0.8	8904	
ZX	1997 →	OE108	RN3C	0.7	8904	PRO-5M
ZX 11PS	1997 →	OE108	RN3C	0.6	8904	PRO-5M
ZX 15PS	1997 →	OE091	RN2C	0.6	8904	PRO-5M
ZX Offroad (Liquid cooled)	2001 →	OE108	RN3C	0.6	8904	PRO-5M
ZZ A	2001 →	OE091	RN2C	0.8	8904	
ZZ B	2001 →	OE108	RN3C	0.8	8904	
ZZ Funbike (Liquid cooled)	2000 →	OE108	RN3C	0.6	8904	

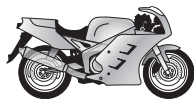
**21****POWER
SPORT****...SACHS**

175cc	GS		OE040	N2C	0.5	8904
250cc	GS		OE040	N2C	0.5	8904
294cc	W 2000		OE098	RN4C	0.5	8339
350cc	GS		OE125	N2G	0.5	8904
650cc	Roadster	1999 →	OE092	RG4HC	0.8	8698
800cc	Roadster (Liquid cooled)	2000 →	OE083	RA6HC	0.9	8809

SANGLAS

350cc	350		OE001	N9YC	0.8	8415
400cc	E		OE001	N9YC	0.8	8415
	Y (Yamaha mot.)		OE010	N7YC	0.8	8332
500cc	S/S2-V5		OE001	N9YC	0.8	8415

SANLG

125cc	CG125			P-RA7HC		8812
150cc	CG150			P-RA7HC		8812
	GN			P-RG7C		
	GZ			P-RG7C		

SANYANG

50cc	Big Wheel SYM	1995 →		L78C	0.5	8883
	Bullet			RL78C	0.6	8883
	Dio			RL78C	0.6	8883
	Fancy Super SYM	1995 →		L78C	0.5	8883
	Fancy SYM	1995 →		L78C	0.5	8883
125cc	Duke Super SYM	1995 →		Z6	0.5	
	Duke SYM	1995 →		Z6	0.5	

SAROLEA

350cc	HMW 50N		OE037	L86C	0.5	
-------	---------	--	--------------	------	-----	--

SCO

	Minor		OE037	L86C	0.5	
	Popular		OE037	L86C	0.5	
	Racer		OE037	L86C	0.5	
	Super		OE037	L86C	0.5	
	Transporter		OE037	L86C	0.5	

SCORPA

250cc	Easy Trial	1994 →	OE001	N9YC	0.7	8415
	SY	2001 →	OE023	C9YCC	0.7	
280cc	Easy Trial	1994 →	OE001	N9YC	0.7	8415

SEMIAC

	VAP 610		OE037	L86C	0.6	
--	---------	--	--------------	------	-----	--

SERVETA (→ Lambretta)**SHE LUNG**

50cc	Club (I)		OE007	L87YC	0.6	
	Racer (I)		OE007	L87YC	0.6	

SHERCO

50cc	Trial Kid	2002 →	OE091	RN2C		8904
125cc	City Corp	2005 →	OE001	N9YC	0.7	8415
	Trail 1,2	2000 →	OE001	N9YC	0.5	8415
250cc	Scottish Six Days Winner	2000 →	OE001	N9YC	0.5	8415
	Trail 2,5	2000 →	OE001	N9YC	0.5	8415
	Trail 2,9	2000 →	OE001	N9YC	0.5	8415
450cc	4.5 4T	2005 →		RG94C	0.7	8698

**SHERCO**

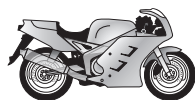
**21****POWER
SPORT****SHERCO- HRD**

50cc	Enduro	2002 →	OE108	RN3C	0.5	8904
	Super Motard	2002 →	OE108	RN3C	0.5	8904

SIMONINI IMEA

50cc	Competizione Sachs		OE125	N2G	0.5	8904
	Indian			L78C	0.5	8883
	Indian		OE037	L86C	0.6	
	Masetti Racing		OE125	N2G	0.5	8904
	Masetti Strada		OE125	N2G	0.5	8904
	Mustang Rino Baby			L78C	0.5	8883
	SF		OE125	N2G	0.5	8904
	Speedy 2 Morini			L82C	0.5	8814
125cc	Mustang Regolarita		OE125	N2G	0.5	8904
250cc	Diamond Sachs		OE125	N2G	0.5	8904
	Hard Racer		OE125	N2G	0.5	8904
	Mustang A		OE125	N2G	0.5	8904
	Mustang Cross SA		OE125	N2G	0.5	8904
	Mustang Cross SSH20		OE125	N2G	0.5	8904
	Mustang H20		OE125	N2G	0.5	8904
	Shadow		OE125	N2G	0.5	8904

SIMSON

50cc	Albatros SD 50, SD50 E	1996 →		L82C	0.5	8814
	AT	1990 →		L82C	0.5	8814
	Bunny	1987 →1990		L82C	0.5	8814
	Delta SD	1994 →1995		L82C	0.5	8814
	Gamma 1 R	1993 →1995		L82C	0.5	8814
	Habicht 25	1996 →		L82C	0.5	8814
	Habicht 50	1996 →		L82C	0.5	8814
	Habicht 50 Basic	1996 →		L82C	0.5	8814
	Habicht 50S	1996 →		L82C	0.5	8814
	Kleinkraftrad			L82C	0.5	8814
	S 51 B2-4	1981 →1990		L82C	0.5	8814
	S 51 Enduro	1981 →1990		L82C	0.5	8814
	S 53	1990 →		L82C	0.5	8814
	S B1	1976 →1982		L82C	0.5	8814
	S N	1982 →1990		L82C	0.5	8814
	Sperber	1997 →		L82C	0.5	8814
	Sperber Basic	1996 →		L82C	0.5	8814
Trucky SD CT	1992 →1995		RL87YC	0.5		
51cc	S	1976 →1982		L82C	0.5	8814
	Swift	1976 →1982		L82C	0.5	8814
53cc	Alpha S53	1992 →1995		L82C	0.5	8814
	Alpha S53	1992 →1995		L82C	0.5	8814
	Beta S53	1992 →1995		L82C	0.5	8814
70cc	GS	1975 →1990		L82C	0.5	8814
	Leichtkraftrad	1980 →1990		L82C	0.5	8814
	S C, E/2	1980 →1990		L82C	0.5	8814
80cc	Habicht	1996 →		L82C	0.5	8814
	Habicht Basic	1996 →		L82C	0.5	8814
	Habicht S	1996 →		L82C	0.5	8814
	Sperber Basic	1996 →		L82C	0.5	8814
	Super S	1992 →1995		L82C	0.5	8814
83cc	Alpha S	1992 →1995		L82C	0.5	8814
	Beta S	1992 →1995		L82C	0.5	8814

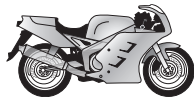
**21****POWER SPORT****SIS**

50cc				mm		
4 Cyclone			L78C	0.5	8883	
505 1D		OE037	L86C	0.5		
505 1DSK		OE037	L86C	0.5		
Almirante 4/5			L78C	0.5	8883	
Asa d'Ouro		OE037	L86C	0.6		
Brass		OE037	L86C	0.6		
Eko 70			L82C	0.5	8814	
Enduro			L78C	0.5	8883	
Felino			L78C	0.5	8883	
Fuego			L78C	0.5	8883	
Lebra / V4			L78C	0.5	8883	
Lotus			L78C	0.5	8883	
Mini Sport			L78C	0.5	8883	
Mini Turismo			L78C	0.5	8883	
Minor		OE037	L86C	0.5		
Minor GT		OE037	L86C	0.6		
Motozak			L78C	0.5	8883	
S (Moped Eng.)			L78C	0.5	8883	
S 6 (Moped Eng.)			L78C	0.5	8883	
Saxy		OE037	L86C	0.5		
Top			L78C	0.5	8883	
V5			L78C	0.5	8883	
V5 Sport			L78C	0.5	8883	
V5 Super Sport			L78C	0.5	8883	
V5 Turismo			L78C	0.5	8883	

SMC

50cc						
NAF Navigator		OE064	RL82YC	0.7	8814	
NGF Sports Force		OE064	RL82YC	0.7	8814	
NKF		OE064	RL82YC	0.7	8814	
NLFR Caprillio		OE064	RL82YC	0.7	8814	
PAF Partner		OE064	RL82YC	0.7	8814	
SBF Super		OE064	RL82YC	0.7	8814	
90cc						
NGN Sports Force		OE064	RL82YC	0.7	8814	
SBN Super		OE064	RL82YC	0.7	8814	
100cc						
NKO		OE064	RL82YC	0.7	8814	
SBO Super		OE064	RL82YC	0.7	8814	
125cc						
CHP Chopper		OE083	RA6HC	0.8	8809	

SOLEX (→ Velosolex)**SOLIFER**

50cc						
Auto		OE037	L86C	0.5		
Berini		OE037	L86C	0.5		
Export Automatic		OE037	L86C	0.5		
Express		OE037	L86C	0.5		
F38 (Anker-Laura mot.)		OE037	L86C	0.5		
P50		OE004	RN9YCC	0.8	8415	
Pluvier		OE037	L86C	0.5		
PV50		OE004	RN9YCC	0.8	8415	
PY50		OE004	RN9YCC	0.8	8415	
SM80		OE037	L86C	0.5		
Tomos		OE037	L86C	0.5		
TS		OE037	L86C	0.5		

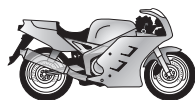

**21****POWER
SPORT**

SOLO						
50cc	Mofas 712		OE037 L86C	0.5		
	Mofas 713		OE037 L86C	0.5		
	Mofas 722		OE037 L86C	0.5		
	Mofas 725		OE037 L86C	0.5		
	Mofas 726		OE037 L86C	0.5		
	Type 236 (Mofa mot.)		OE037 L86C	0.5		
	Type 237 (Mofa mot.)		OE037 L86C	0.5		
SPARTA						
50cc	Buddy		OE037 L86C	0.6		
	GE 50		OE037 L86C	0.5		
	Happy		OE037 L86C	0.6		
	JLO FP50		OE037 L86C	0.5		
	JLO Piano G50AV		OE037 L86C	0.5		
	Lucky		OE037 L86C	0.6		
	M23		OE037 L86C	0.5		
	MB50		OE037 L86C	0.5		
	MC50		OE037 L86C	0.5		
	Sport 2V		OE037 L86C	0.6		
	Sport 3V		OE037 L86C	0.6		
	Tour Automatica		OE037 L86C	0.6		
	TVG50		OE037 L86C	0.5		
STARFLITE						
50cc	25 (Laura M48-15B)		OE037 L86C	0.6		
	40 (Laura M48-11B)		OE037 L86C	0.6		
	Bronco		OE037 L86C	0.6		
	City Laura M48-15B		OE037 L86C	0.6		
	GTM (F&S 501 BKF)		OE037 L86C	0.6		
	GTS (F&S 50SA)		L78C	0.5	8883	
	Tramp (Laura M48-15)		OE037 L86C	0.6		
STEEN						
100cc	F Series Hodaka		RJ6C	0.5		
STEYR DAIMLER PUCH (→ Puch)						
SUNBEAM						
	14mm Heads		RL86C	0.8		
	18mm Heads		D6	0.8		
SUZUKI						
50cc	A D		L78C	0.6	8883	
	A K, KB, P, PB		QL78C	0.6	8883	PRO-5M
	AC		L78C	0.6	8883	
	AC D		OE086 RL82C	0.6	8814	
	AC Mk II		L78C	0.6	8883	
	AE	1993 →	OE064 RL82YC	0.8	8814	PRO-5M
	ALT		OE059 L92YC	0.6		
	AM		QL78C	0.6	8883	
	AS		OE086 RL82C	0.6	8814	
	Borrasca		OE086 RL82C	0.6	8814	
	CA		OE007 L87YC	0.6		
	CL		OE059 L92YC	0.6		PRO-5M
	CL DO Mk2		OE059 L92YC	0.6		PRO-5M
	CM		L78C	0.6	8883	
	Condor		OE086 RL82C	0.6	8814	

**SOLO**

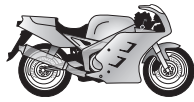
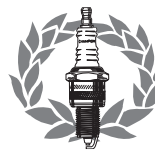
**21****POWER
SPORT****...SUZUKI****...50cc**

CS		OE059	L92YC	0.6		PRO-5M
CS DD Roadie		OE059	L92YC	0.6		PRO-5M
CX		OE064	RL82YC	0.8	8814	PRO-5M
CY F		OE064	RL82YC	0.8	8814	PRO-5M
DM		OE064	RL82YC	0.8	8814	PRO-5M
DR Big	1989 →	OE086	RL82C	0.6	8814	PRO-5M
DR W		OE086	RL82C	0.6	8814	
DR W		OE091	RN2C	0.5	8904	
DS X		OE064	RL82YC	0.8	8814	
DV (CA14C)		OE064	RL82YC	0.8	8814	PRO-5M
EM		OE064	RL82YC	0.8	8814	
F Cutlass		OE007	L87YC	0.6		
FA		OE059	L92YC	0.6		PRO-5M
FB K	1989 → 1991		P-RZ9HC	0.7		
FB M	1991 →		P-RZ9HC	0.7		
FM A		OE059	L92YC	0.6		
FR		OE059	L92YC	0.6		PRO-5M
FS		OE059	L92YC	0.6		PRO-5M
FY		OE059	L92YC	0.6		
FZ		OE059	L92YC	0.6		PRO-5M
Genma		OE059	L92YC	0.6		
GN		OE087	N6YC	0.6	8902	
GT E, K, KE, P		OE007	L87YC	0.6		PRO-5M
GT KB, KN		OE059	L92YC	0.6		PRO-5M
JR	1993 → 1994	OE059	L92YC	0.6		
JR	1995 →		RL95YC	0.7		
JR (JA143)			RL95YC	0.7		
K		OE064	RL82YC	0.8	8814	
Katana AY aircooled	1997 →	OE064	RL82YC	0.8	8814	
Katana AY watercooled	1997 →	OE064	RL82YC	0.8	8814	
Lido Variant		OE007	L87YC	0.6		
M		OE064	RL82YC	0.8	8814	
M 12		OE064	RL82YC	0.8	8814	
Maverick			L78C	0.6	8883	PRO-5M
Maxi			L82C	0.6	8814	PRO-5M
Mini Cross,TT			L82C	0.6	8814	
Monza			L82C	0.6	8814	
MT R Trial Hopper		OE007	L87YC	0.6		
OM P		OE007	L87YC	0.6		
OR		OE007	L87YC	0.6		PRO-5M
OR E		OE007	L87YC	0.6		PRO-5M
OR ET		OE007	L87YC	0.6		PRO-5M
OS P		OE007	L87YC	0.6		
PV		OE084	N6YCC	0.8	8902	
PV G		OE007	L87YC	0.6		
R K, KE		OE084	N6YCC	0.8	8902	
RAN		OE007	L87YC	0.6		
RB GAG	1988 →		RZ96C	0.7		PRO-5M
RG E, W		OE116	RN6YC	0.6	8902	PRO-5M
RG KE		OE084	N6YCC	0.8	8902	PRO-5M
RM		OE086	RL82C	0.6	8814	PRO-5M
RMX		OE116	RN6YC	0.6	8902	PRO-5M
RMX			RL87YC	0.6		PRO-5M
RN		OE007	L87YC	0.6		PRO-5M

**SUZUKI**

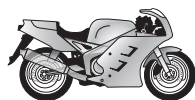
**21****POWER
SPORT****...SUZUKI**

Capacity	Model	Year	Part No.	Thread	Gap	Material
...50cc	RT		OE007 L87YC	0.6		
	RV		OE007 L87YC	0.6		PRO-5M
	RV S (RV50)		OE007 L87YC	0.6		PRO-5M
	SMX X	1999 →	OE116 RN6YC	0.6	8902	
	Suzi NM50		RL87YC	0.6		PRO-5M
	Suzy	1995 →	OE064 RL82YC	0.6	8814	PRO-5M
	TR		OE059 L92YC	0.7		PRO-5M
	TR Street Magic	1998 →	OE064 RL82YC	0.6	8814	PRO-5M
	TS		OE007 L87YC	0.6		PRO-5M
	TS 12,7mm / 1/2in.		OE038 L82YC	0.6	8814	PRO-5M
	TS 19,0mm / 3/4in.		L82C	0.6	8814	PRO-5M
	TS ER, ERA, ERAP, K, P, X, XAE		OE007 L87YC	0.6		PRO-5M
	TS ERKT		OE007 L87YC	0.6		PRO-5M
	TS K		OE008 RN7YCC	0.8	8332	PRO-5M
	TS R		OE007 L87YC	0.6		PRO-5M
	TS XK		OE004 RN9YCC	0.8	8415	PRO-5M
	U		OE086 RL82C	0.6	8814	
	ZR K, KE, P, SAP, SK, SL		OE004 RN9YCC	0.8	8415	PRO-5M
ZR SALP, SLK, SLP, SLA		OE004 RN9YCC	0.8	8415	PRO-5M	
ZR XI		OE008 RN7YCC	0.8	8332	PRO-5M	
55cc	M 30		RJ6C	0.6		
	M 31		RJ6C	0.6		
	M 32		RJ8C	0.6		
60cc	RM		L78C	0.6	8883	
65cc	RM	2004 →	RN57YCC	0.6		
70cc	F 3, U70W		OE064 RL82YC	0.8	8814	
	FR M		OE064 RL82YC	0.8	8814	
75cc	CM		L78C	0.6	8883	
	CP		OE064 RL82YC	0.8	8814	
	FR		OE007 L87YC	0.6		
	RV		L78C	0.6	8883	
	TM		OE086 RL82C	0.6	8814	
	TS		OE086 RL82C	0.6	8814	
80cc	A		OE064 RL82YC	0.8	8814	
	AG W		OE091 RN2C	0.6	8904	
	CP		OE064 RL82YC	0.8	8814	
	CS		OE108 RN3C	0.6	8904	PRO-5M
	CS Roller		OE064 RL82YC	0.8	8814	PRO-5M
	DS	1995 →	OE010 N7YC	0.6	8332	PRO-5M
	DS	1993 → 1994	OE079 N4C	0.6	8339	PRO-5M
	FB J,K	1988 → 1991	P-RZ9HC	0.7		
	FB M	1991 →	P-RZ9HC	0.7		
	FR D, K, M		OE064 RL82YC	0.8	8814	PRO-5M
	GN E		OE108 RN3C	0.6	8904	
	GT EX, LX (GT80)		OE108 RN3C	0.6	8904	PRO-5M
	JR	2002 →	OE098 RN4C	0.6	8339	
	RC D 4x4		OE064 RL82YC	0.8	8814	
	RG C, E, G		OE008 RN7YCC	0.8	8332	PRO-5M
	RG G, Gamma (NC11A)		OE098 RN4C	0.6	8339	PRO-5M
	RG WF, W		OE008 RN7YCC	0.8	8332	PRO-5M
	RM C, N, X, XT, XX, XZ		OE091 RN2C	0.6	8904	PRO-5M
	RM H, HD, XD		OE091 RN2C	0.6	8904	PRO-5M
	RM HD, HE, HF, XD, XE, XF, XG, XH, XJ		OE091 RN2C	0.6	8904	PRO-5M
	RMX T, V, W, X	1996 →	QC57C			

SUZUKI

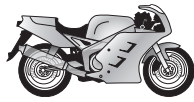
**21****POWER
SPORT****...SUZUKI**

...80cc	RT Z		OE079	N4C	0.6	8339	
	TS ERX		OE098	RN4C	0.6	8339	PRO-5M
	TS X (SA11A)		OE010	N7YC	0.8	8332	PRO-5M
	TS XE-H (SC11A)		OE084	N6YCC	0.8	8902	PRO-5M
	X3E		OE084	N6YCC	0.8	8902	PRO-5M
85cc	RM	2001→		RN1C		8904	
90cc	Birdie Scooter (BD42A)	2001→		P-RZ9HC			
	Blazer			L78C	0.6	8883	
	FM		OE007	L87YC	0.6		PRO-5M
	GS D		OE007	L87YC	0.6		
	K		OE037	L86C	0.6		
	RV		OE007	L87YC	0.6		PRO-5M
	TC			L78C	0.6	8883	
	TS Honcho			L78C	0.6	8883	
100cc	A K, -3		OE086	RL82C	0.6	8814	PRO-5M
	A M, N		OE007	L87YC	0.6		PRO-5M
	A RT		OE091	RN2C	0.6	8904	PRO-5M
	AC			L78C	0.6	8883	
	AS			L78C	0.6	8883	
	AX D		OE007	L87YC	0.6		
	AX D1		OE108	RN3C	0.6	8904	
	B, P			RJ6C	0.6		
	DR D, H, L	1983→1990	OE083	RA6HC	0.7	8809	
	DR F, G, J, K	1985→	OE083	RA6HC	0.7	8809	
	DS X		OE108	RN3C	0.6	8904	
	FB D S	1986→		P-RZ9HC	0.7		
	FB G, S	1995→		P-RZ9HC	0.7		
	GP C, UDD			L78C	0.6	8883	PRO-5M
	GT			L78C	0.6	8883	
	RC D, DE, E		OE064	RL82YC	0.8	8814	
	RM -, B, C, N, X		OE091	RN2C	0.6	8904	
	SP		OE073	RA4HC	0.6		
	TC FA			L78C	0.6	8883	
	TC K 12,7mm/1/2in.			L78C	0.6	8883	
	TC K 19,0mm/3/4in.		OE068	N3C	0.6	8904	
	TF		OE068	N3C	0.6	8904	
	TS A, B, M, L	→1978		L78C	0.6	8883	PRO-5M
	TS C, ER	1978→	OE068	N3C	0.6	8904	PRO-5M
	TS X	→1977		L78C	0.6	8883	PRO-5M
	TS X	1978→	OE068	N3C	0.6	8904	PRO-5M
110cc	Address	1998→	OE064	RL82YC		8814	
111cc	DR-Z	2003→		P-RZ9HC	0.7		
120cc	B		OE064	RL82YC	0.8	8814	
	B M		OE086	RL82C	0.6	8814	
	KT			RJ6C	0.6		
	TC -II, MR-II			L78C	0.6	8883	
	TS100 C, ER, N		OE108	RN3C	0.6	8904	
125cc	ALT	1983→1986		P-RA7HC	0.7	8812	
	ALT E D, E, F, G (G)		OE083	RA6HC	0.7	8809	
	DF D, G	1983→	OE083	RA6HC	0.7	8809	
	DR F E	1982→	OE083	RA6HC	0.7	8809	
	DR J	1984→	OE083	RA6HC	0.7	8809	
	DR S Z, D, E, F, G, H, L, SJ	1988→	OE083	RA6HC	0.7	8809	
	DR SE S, T (SF42A)	1995→	OE083	RA6HC	0.7	8809	

**SUZUKI**

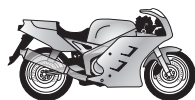
**21****POWER SPORT****...SUZUKI**

...125cc

DS X		OE108	RN3C	0.6	8904	
GN D, ED, ES		OE073	RA4HC	0.6		
GN E P,R	1989 → 1993	OE083	RA6HC	0.7	8809	
GN E S,T	1982 → 1989	OE083	RA6HC	0.7	8809	
GN J,M,N,V	1993 → 1994	OE083	RA6HC	0.7	8809	
GN R Chopper	1995 →	OE083	RA6HC	0.7	8809	
GN Z,D	1995 →	OE073	RA4HC	0.6		
GP			L78C	0.6	8883	PRO-5M
GP D, N, X			L78C	0.6	8883	PRO-5M
GS D, ES, ESO		OE073	RA4HC	0.6		
GS E, ES S, Z, D	1982 →	OE083	RA6HC	0.7	8809	
GS ES F,L,M	1990 →	OE083	RA6HC	0.7	8809	
GS R M	1991 →	OE083	RA6HC	0.7	8809	
GT -11, 2N		OE073	RA4HC	0.6		PRO-5M
GT E, ESZ-2			L78C	0.6	8883	PRO-5M
GZ Marauder W, X	1998 →	OE083	RA6HC	0.8	8809	
K			L78C	0.6	8883	
K M, Z		OE064	RL82YC	0.8	8814	
LT D D, E, F, G, H		OE083	RA6HC	0.6	8809	
LT E, FE	1983 → 1987		P-RA7HC	0.6	8812	
OR S		OE073	RA4HC	0.6		
PE			QN84	0.6		
RA R		OE108	RN3C	0.6	8904	
RC			L82C	0.6	8814	PRO-5M
RG		OE108	RN3C	0.6	8904	PRO-5M
RG A, B, C, D, E, F, G, H, J, N, T, ULG			L78C	0.6	8883	PRO-5M
RG WF, WV, X, Z		OE091	RN2C	0.6	8904	PRO-5M
RM	1987 → 1992	OE091	RN2C	0.6	8904	PRO-5M
RM	1996 → 1997	OE108	RN3C	0.6	8904	PRO-5M
RM	→ 1986	OE125	N2G	0.6	8904	PRO-5M
RM	1993 → 1995		QN84	0.6		PRO-5M
RM E			QN86	0.6		PRO-5M
RV		OE086	RL82C	0.6	8814	
RV (K7)	2007 →		RG94C	0.6	8698	
SP D, E		OE073	RA4HC	0.6		
T			L78C	0.6	8883	
T -IF Stinger			L78C	0.6	8883	
T -II			L78C	0.6	8883	
TC			L78C	0.6	8883	
TF		OE108	RN3C	0.6	8904	
TM		OE086	RL82C	0.6	8814	
TM GEZ		OE108	RN3C	0.6	8904	
TR G, E			L78C	0.6	8883	
TS A,B	1976 → 1977		L78C	0.6	8883	PRO-5M
TS ER,ERT,ERX,ERZ,J,N,R,XE,XJ,XV		OE091	RN2C	0.6	8904	PRO-5M
TS ERN	1979 → 1979	OE087	N6YC	0.6	8902	PRO-5M
TS K,L,M	1973 → 1975		L82C	0.6	8814	PRO-5M
TU XT	1999 →	OE083	RA6HC	0.8	8809	
Van Van	2003 →		RG94C	0.7	8698	
VL Intruder	1999 →		RG94C	0.7	8698	

**SUZUKI**

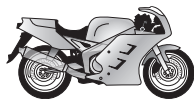

21



POWER
SPORT



...SUZUKI

175cc	DE E			C55R	0.6		
	PE	1979 →	OE125	N2G	0.6	8904	
	PE F	1978 →	OE068	N3C	0.6	8904	
	PR			QN84	0.6		
	RS	1981 →	OE040	N2C	0.6	8904	
	RS	→1980	OE078	N3G	0.6	8904	
185cc	ALT F	1985 →		P-RA7HC	0.7	8812	
	DS TF, X		OE098	RN4C	0.6	8339	
	GT E			L82C	0.6	8814	PRO-5M
	LT E, FE E	1985 →		P-RA7HC	0.6	8812	
	LT F,G,H	→1985		P-RA7HC	0.7	8812	
	RG		OE086	RL82C	0.6	8814	
	TC	→1977	OE086	RL82C	0.6	8814	
	TF	1990 →	OE078	N3G	0.6	8904	
	TS		OE086	RL82C	0.6	8814	PRO-5M
	TS C, ER, ERN, ERT, M, R	1978 →	OE010	N7YC	0.8	8332	PRO-5M
200cc	B		OE078	N3G	0.6	8904	
	B N	1980 →	OE001	N9YC	0.8	8415	
	DF E T	1996 →	OE083	RA6HC	0.6	8809	
	DR G, J	1986 →1988	OE083	RA6HC	0.6	8809	
	DR H	1987 →	OE083	RA6HC	0.6	8809	
	DR S F	1985 →	OE083	RA6HC	0.6	8809	
	DR S G, H, J, L	1986 →	OE083	RA6HC	0.6	8809	
	DR SE S, T, SZ	1995 →	OE083	RA6HC	0.6	8809	
	GT	1980 →	OE078	N3G	0.6	8904	PRO-5M
	SB Z		OE078	N3G	0.6	8904	
	SP		OE073	RA4HC	0.6		
	SX R		OE073	RA4HC	0.6		
	T			L78C	0.6	8883	
	TC			L78C	0.6	8883	
	TS R		OE091	RN2C	0.6	8904	PRO-5M
230cc	TS XE		OE108	RN3C	0.6	8904	
240cc	TS X		OE108	RN3C	0.6	8904	
250cc	DF H	1987 →	OE083	RA6HC	0.6	8809	
	DR E, F, L, M, N, P, R, S, SE, SZ	1990 →		RAX92YC	0.8	8809	
	DR E, F, L, M, N, P, R, S, SE, SZ	→1989	OE083	RA6HC	0.6	8809	
	DR SZ-H		OE083	RA6HC	0.6	8809	
	DS X		OE008	RN7YCC	0.8	8332	
	GF J	1988 →		RZ94C	0.7		
	GN D, E, F, J, L, M, N, P, T, Z		OE083	RA6HC	0.7	8809	
	GNX	1982 →1984	OE083	RA6HC	0.7	8809	
	GS FW, FWS D	1983 →	OE083	RA6HC	0.6	8809	
	GS T, XT T, X, Z	1980 →		RAX92C	0.6	8809	
	GSX		OE073	RA4HC	0.6		
	GSX E, ES EP X, Z, D			G55R	0.6		
	GSX ET, EX	1981 →		RAX92C	0.7	8809	
	GSX F M, N, P, T	1980 →		RAX92C	0.7	8809	
	GSX L, T, TI	1991 →		RZ96C	0.6		SRO-5U
	GSXR R J	1989 →	OE092	RG4HC	0.7	8698	
	GT 19,0mm/3/4in.		OE091	RN2C	0.6	8904	
	GT K, E 12,7mm/1/2in.		OE064	RL82YC	0.8	8814	
	GZ Marauder X	1999 →	OE083	RA6HC	1.8	8809	
	NZ H	1987 →	OE083	RA6HC	0.9	8809	
	PE	1980 →	OE040	N2C	0.6	8904	

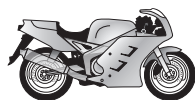

SUZUKI

**21****POWER
SPORT****...SUZUKI**

Capacity	Model	Year	OE Part No.	Part No.	Gap (mm)	Part No.	Part No.
...250cc	PE	→1979	OE078	N3G	0.6	8904	
	R			G55R	0.6		
	RG CH,FCH,G,G-CH,FG,WE (GJ21A)		OE091	RN2C	0.6	8904	
	RGV L (VJ21A)		OE091	RN2C	0.6	8904	
	RGV M,N	1991 →		QN84	0.6		
	RH			QN86	0.6		
	RL		OE098	RN4C	0.6	8339	
	RM	1982 →1992	OE078	N3G	0.6	8904	
	RM	2001 →2003	OE108	RN3C	0.6	8904	
	RM	→1981	OE125	N2G	0.6	8904	
	RM	1993 →2000		QN84	0.6		
	RM D	1982 →		QN86	0.6		
	RMX		OE125	N2G	0.6	8904	
	RM-Z	2007 →		RG94C	1.0	8698	
	RM-Z	2004 →2006		RG94C	0.6	8698	
	RS		OE108	RN3C	0.6	8904	
	SP		OE073	RA4HC	0.6		
	T			L77JC4	1.0	8883	
	T			L78C	0.6	8883	
	T J, II Top Speed			L78C	0.6	8883	
	T J, R, II			L77JC4	1.0	8883	
	TC			L77JC4	1.0	8883	
	TC Top Speed			L78C	0.6	8883	
	TM A, M		OE108	RN3C	0.6	8904	
	TR		OE108	RN3C	0.6	8904	
	TS (SJ11D)		OE091	RN2C	0.6	8904	
	TS M/R, ER		OE018	RN7YC	0.6	8332	
TS X, XE, G-K		OE098	RN4C	0.6	8339		
TU X	1997 →	OE083	RA6HC	0.7	8809		
Volty I, -II, -C J		OE083	RA6HC	0.7	8809		
300cc	GS L		OE073	RA4HC	0.6		
	GSX L, LF		OE073	RA4HC	0.6		
	Rebel			L78C	0.6	8883	
	T 305			L78C	0.6	8883	
	TC 30 R			L78C	0.6	8883	
325cc	RL		OE108	RN3C	0.6	8904	
350cc	DR N	1995 →	OE092	RG4HC	0.7	8698	
	DR S L,M,N,P			RA2HC	0.9		
	DR S,T	1990 →1994		RAX92YC	0.8	8809	
	DR SE, SZ S,T	1995 →	OE092	RG4HC	0.7	8698	
	DR SH N,P	1992 →		RAX92YC	0.8	8809	
	Goose	1993 →	OE092	RG4HC	0.7	8698	
	T II Rebel		OE086	RL82C	0.6	8814	
370cc	DR		OE073	RA4HC	0.6		
	RM		OE040	N2C	0.6	8904	
	SP		OE073	RA4HC	0.6		
380cc	GE		OE078	N3G	0.6	8904	
	GT		OE078	N3G	0.6	8904	
400cc	DR S	1980 →1983	OE083	RA6HC	0.6	8809	
	DR Z	2000 →		RG94C	0.7	8698	
	GN LI,TD,TDX,TX,TT (GS400)	1981 →	OE083	RA6HC	0.7	8809	
	GS R,C,EC,N,EN,X,TX (GL51F)		OE078	N3G	0.6	8904	
	GSF Bandit	1992 →	OE092	RG4HC	0.7	8698	SRO-5U
	GSF Bandit	→1991		RG94C	0.7	8698	SRO-5U

**SUZUKI**

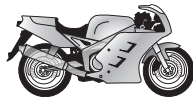
**21****POWER SPORT****...SUZUKI****...400cc**

GSX D, E, FF, LX, S, SE, X, Z	1981 →	OE083	RA6HC	0.6	8809	SRO-5U
GSX E (GS40X)	1983 → 1987	OE083	RA6HC	0.7	8809	SRO-5U
GSX EE, ED, EZ, FD, FX, FZ, LT, TD		OE073	RA4HC	0.6		SRO-5U
GSX F, FW, E	1984 →		RZ94C	0.6		SRO-5U
GSX FX (GS40X)	1982 →	OE073	RA4HC	0.6		SRO-5U
GSX LX	1988 →	OE073	RA4HC	0.6		SRO-5U
GSX S	1983 → 1987	OE083	RA6HC	0.7	8809	SRO-5U
GSX SE, EF (GK53C)		OE073	RA4HC	0.6		SRO-5U
GSX SF, EG, SG (GK53C)		OE073	RA4HC	0.6		SRO-5U
GSXR F	1985 →		RZ94C	0.6		SRO-5U
GSXR K	1989 → 1990	OE092	RG4HC	0.7	8698	SRO-5U
GSXR R L	1990 →	OE092	RG4HC	0.7	8698	SRO-5U
GSXR R M	1991 →	OE092	RG4HC	0.7	8698	SRO-5U
GSXR RF M	1991 →	OE092	RG4HC	0.7	8698	SRO-5U
LS Savage			RA2HC	0.6		
ON	1980 →	OE091	RN2C	0.6	8904	
PE X	1980 →	OE091	RN2C	0.6	8904	
RG SKB		OE108	RN3C	0.6	8904	
RM		OE108	RN3C	0.6	8904	
SP		OE073	RA4HC	0.6		
TM R Cyclone		OE108	RN3C	0.6	8904	
TS		OE098	RN4C	0.6	8339	
VS	1995 →	OE083	RA6HC	0.8	8809	

425cc

GS	1984 →	OE098	RN4C	0.6	8339	
GS E		OE078	N3G	0.6	8904	

450cc

GS E, EG, ES, EU, EX, GA, L, LT, SF, TX, X		OE108	RN3C	0.6	8904	
GS EU, SU, S		OE073	RA4HC	0.6		
RMZ	2004 → 2006		RG94C	1.0	8698	
RMZ	2008 →		RG94C	1.0	8698	
RMZ	2007 →		RG94C	1.0	8698	

465cc

RM		OE078	N3G	0.6	8904	
----	--	--------------	-----	-----	-------------	--

495cc

RM		OE078	N3G	0.6	8904	
----	--	--------------	-----	-----	-------------	--

500cc

DR D, R, S			RA2HC	0.6		
DR R, S G, H, J	1986 →		RAX92YC	0.8	8809	
DR S X, Z	1981 → 1984	OE083	RA6HC	0.6	8809	
GS E Tourer (GM51B)	→ 1994	OE073	RA4HC	0.9		
GS E Tourer (GM51B)	1994 →	OE073	RA4HC	0.9		
GS E, EU, K, L, M, N, P, R, S, T	1989 →	OE083	RA6HC	0.9	8809	
GS EK (GM51D)	1989 →	OE073	RA4HC	0.9		
GS EX, LX, MX		OE083	RA6HC	0.6	8809	
GS F	2004 →	OE083	RA6HC	0.9	8809	
GS N (GS500)		OE091	RN2C	0.6	8904	
GSX E, ES, EF, EU F, G, H	1985 →		RAX92C	0.6	8809	
GSX L F	1985 →		RAX92C	0.6	8809	
GT		OE086	RL82C	0.6	8814	
RG			QN84	0.6		
RG Gamma	1987 →		QN84	0.6		
RG Road Racer (HM31A)		OE091	RN2C	0.6	8904	
RM D, E, F, TE	1983 →	OE108	RN3C	0.6	8904	
SP E, P		OE073	RA4HC	0.6		
T -2 MKII			L78C	0.6	8883	
T R Titan		OE086	RL82C	0.6	8814	
T Titan			L78C	0.6	8883	

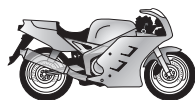

**21****POWER
SPORT****...SUZUKI**

Capacity	Model	Year	Part No.	Thread	Gap (mm)	Part No.	Notes
550cc	GS E, ES (GS550)	1984→	OE091	RN2C	0.6	8904	
	GS MX, LN, T		OE091	RN2C	0.6	8904	
	GSX (GN71D)		OE073	RA4HC	0.6		
	GSX E (GN71D)		OE073	RA4HC	0.6		
	GSX E, ES, L, FU, SU D, E, G, H (GN71D)	1984→	OE091	RN2C	0.6	8904	
	GSX EF	1983→		RAX92C	0.7	8809	SRO-5U
	GSX ESD-H (GN71D)	1984→		RAX92C	0.6	8809	
	GSX EU E, F, G, H (GN71D)	1984→		RA2HC	0.9		
	GT AB, K, M		OE091	RN2C	0.6	8904	PRO-5M
	600cc	DR (SN41B)			RA2HC	0.9	
DR R H,J,K (SN41A)				RA2HC	0.9		
DR R I H,J,K (SN41A)		1987→		RAX92YC	0.8	8809	
DR S F,G,H,J,K (E34)		1986→		RAX92YC	0.8	8809	
DR S, SU, R, RU (SN41A)		1985→		RAX92YC	0.8	8809	
DR SF-K, SG (SN41B)		1989→	OE073	RA4HC	0.9		
DR SUF-SUK (SN41B)				RA2HC	0.9		
GS FJ		1988→		RAX92C	0.8	8809	
GSF Bandit (GN77B)		1995→	OE092	RG4HC	0.7	8698	
GSF S, SU Bandit		1996→	OE092	RG4HC	0.7	8698	
GSF U Bandit		1995→	OE092	RG4HC	0.7	8698	
GSF Y		2000→	OE092	RG4HC	0.7	8698	
GSR		2006→	OE092	RG4HC	0.7	8698	
GSX F (GN72B)		1988→1995		RAX92C	0.7	8809	
GSX F (10mm) (GN72B)		1996→	OE092	RG4HC	0.7	8698	
GSX F (12mm) (GN72B)		1996→		RAX92C	0.7	8809	
GSX FU, FU2, EF, ES, FJ H (GN72B)		1987→		RAX92C	0.7	8809	
GSXR		2001→	OE092	RG4HC	0.7	8698	
GSXR I (Direct Ignition)		1996→	OE092	RG4HC	0.7	8698	
LS Savage				RA2HC	0.9		
RF R, RU (GN76B)		1993→	OE092	RG4HC	0.7	8698	
TG K				RA2HC	0.9		
VS GL, GLU Intruder		1995→	OE083	RA6HC	0.9	8809	
650cc	DL V-Strom	2004→2005		RG94C	0.8	8698	
	DL V-Strom Twinspark	2006→		RG94C	0.8	8698	
	DR R, RU, RE, RS, RSU, RSE, RSEU (SP44B)	1990→		RAX92YC	0.9	8809	
	DR SET	1996→2000	OE092	RG4HC	0.7	8698	
	GR E	1983→	OE083	RA6HC	0.7	8809	
	GR G, XG	1982→1990	OE073	RA4HC	0.6		
	GR X D,E (GP51A)	1984→1990	OE073	RA4HC	0.6		
	GS E, G, GL, GT X, Z, D	1981→	OE083	RA6HC	0.6	8809	
	GS XN 85 Turbo	1983→		RAX92C	0.6	8809	
	GSF	2007→	OE092	RG4HC	0.7	8698	
	GSF	2005→2006			0.7	8698	
	GX (GP51A)	1984→1990	OE073	RA4HC	0.6		
	GX (GP51A)	1984→1990	OE073	RA4HC	0.6		
	LS Savage (NP41B)	→1994		RA2HC	0.6		
	LS Savage G,H,J,K,L,M,N,P,R	1986→1995	OE083	RA6HC	0.8	8809	
	LS Savage S,T	1995→	OE083	RA6HC	0.8	8809	
	SV ,S (V-Twin)	2003→		RG94C	0.6	8698	
	SV ,S,SU (V-Twin)	1998→2002	OE092	RG4HC	0.6	8698	
	XF Freewind (Air/Oil cooled)	1997→	OE092	RG4HC	0.6	8698	
700cc	GV GL	1985→	OE083	RA6HC	0.6	8809	
	VS GL	1986→	OE073	RA4HC	0.6		

SUZUKI

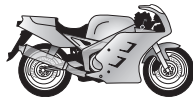
**21****POWER
SPORT****...SUZUKI****750cc**

DR S, SJ, SUJ, K DR Big (SR41B)	1988 →		RAX92YC	0.8	8809	
GS D, E, L, P	1983 →	OE091	RN2C	0.6	8904	
GS S G	1986 →	OE083	RA6HC	0.7	8809	
GSX E (GR71A)	1980 →	OE083	RA6HC	0.6	8809	SRO-5U
GSX EF E,F (GR72A)	1984 →	OE083	RA6HC	0.6	8809	SRO-5U
GSX EFE, EFG (GR72A)	1984 →	OE073	RA4HC	0.6		SRO-5U
GSX ES (GR71A)	1980 →	OE083	RA6HC	0.6	8809	SRO-5U
GSX ESD, ESE (GR72A)	1984 →		RA2HC	0.6		SRO-5U
GSX ESD-ESG, ESG (GR72A)	1984 →	OE073	RA4HC	0.6		SRO-5U
GSX EZ (GR71A)	1983 →	OE073	RA4HC	0.6		SRO-5U
GSX F (GR78A)	1989 →1997		RAX92DC	0.7	8809	SRO-5U
GSX F,W,AK,AE (GR78A)	1998 →	OE092	RG4HC	0.7	8698	SRO-5U
GSX L	1980 →	OE083	RA6HC	0.6	8809	SRO-5U
GSX R	1994 →		RA2HC	0.6		SRO-5U
GSX S	1980 →	OE083	RA6HC	0.6	8809	SRO-5U
GSX S Kantana D	1983 →	OE083	RA6HC	0.6	8809	SRO-5U
GSX S Kantana E	1984 →		RAX92C	0.6	8809	SRO-5U
GSX S Kantana F	1985 →	OE083	RA6HC	0.6	8809	SRO-5U
GSX S, ED, ESD	1981 →	OE073	RA4HC	0.6		SRO-5U
GSX T	1980 →	OE083	RA6HC	0.6	8809	SRO-5U
GSXR (K6)	2004 →2005	OE092	RG4HC	0.7	8698	
GSXR (WVB3)	2006 →	OE092	RG4HC	0.7	8698	
GSXR F,G,H	1985 →1987		RAX92C	0.7	8809	
GSXR J,K	1988 →1989		RAX92DC	0.7	8809	
GSXR J-K	1988 →		A59C	0.6		
GSXR L,M	1990 →1995	OE073	RA4HC	0.6		
GSXR RG	1986 →		RAX92C	0.6	8809	
GSXR RK		OE073	RA4HC	0.6		
GSXR T	1996 →	OE092	RG4HC	0.7	8698	
GSXR W N	1992 →	OE092	RG4HC	0.7	8698	
GSXR W P,R	1993 →1994	OE092	RG4HC	0.7	8698	
GSXR W S	1995 →	OE092	RG4HC	0.7	8698	
GSXR Y	2000 →2003	OE092	RG4HC	0.7	8698	
GT		OE040	N2C	0.5	8904	
VS GL, GLE F, G, H, J, K (VR51B)	1985 →	OE083	RA6HC	0.9	8809	SRO-5U
VS GL, PG, GLF (VR51B)	→1987		RA2HC	0.9		SRO-5U
VS GLP, GLF L,M	1990 →	OE083	RA6HC	0.9	8809	SRO-5U
VS L-M (VR51B)	1990 →	OE083	RA6HC	0.9	8809	SRO-5U

800cc

DR Big S-SU, L (SR42B)	1994 →		RA2HC	0.9		
DR Big S-SU, L (SR42B)	1991 →		RA2HC	0.9		
DR Big S-SU, M-N C (SR43B)	→1994		RA2HC	0.9		
DR S L,M,N,P,R,S,T	1990 →	OE083	RA6HC	0.9	8809	
DR S L,M,N,P,R,S,T	1990 →		RAX92YC	0.9	8809	
VL Volusia Intruder Liquid cooled	1999 →		P-RA7HC	0.9	8812	
VS GL Intruder Chopper N,P,R,S,T (VS52B)	1992 →	OE083	RA6HC	0.9	8809	
VX L,M,N,P,R,T (VS51B)	1990 →	OE083	RA6HC	0.9	8809	
VZ Marauder	1997 →2004		RAX92YC	0.9	8809	
VZ Marauder	2005 →		P-RA7HC	0.9	8812	

850cc

GS G (GS72A)	1980 →	OE108	RN3C	0.6	8904	
GS GE (GS72A)	1980 →	OE073	RA4HC	0.6		
GS GL (GS72A)	1980 →	OE108	RN3C	0.6	8904	
GS GT E, G (GS72A)	1980 →	OE108	RN3C	0.6	8904	
GS GTZ, GTX, GZ (GS72A)	1984 →	OE091	RN2C	0.6	8904	

900cc

RF R R,S,T (GT73B)	1994 →	OE092	RG4HC	0.7	8698	
RF RS2, RZS R, S (GT73B)	1994 →	OE092	RG4HC	0.7	8698	

SUZUKI

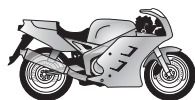
**21****POWER SPORT****...SUZUKI**

Capacity	Model	Year	Part No.	Thread	Gap (mm)	Part No.	Notes
1000cc	GS D,E,H,S,GL,GX		OE068	N3C	0.6	8904	
	GS GG (GU71A)	1986→	OE108	RN3C	0.6	8904	
	GS GT - X (GU71A)	1986→	OE108	RN3C	0.6	8904	
	GSX E	1986→		RA2HC	0.9		
	GSX S Z,D	1982→	OE083	RA6HC	0.6	8809	
	GSXR	2001→2006	OE092	RG4HC	0.7	8698	
	GSXR	→2000		RAX92DC	0.7	8809	
	GSXR (K7)	2007→	OE122	RG4PHP	0.9	8698	
	SV	2003→		RG94C	0.7	8698	
	SV S	2003→		RG94C	0.7	8698	
	TL R	1998→	OE092	RG4HC	0.8	8698	
	TL S	1996→		RG94C	0.8	8698	
	V-Strom	2002→		RG94C	0.8	8698	
1100cc	GS E F	1985→		RAX92YC	0.8	8809	
	GS E G	1986→		RAX92C	0.7	8809	
	GS E, EF E, G	1984→1986		RAX92C	0.6	8809	
	GS EF F 1150	1985→		RAX92C	0.6	8809	
	GS GE, GF	1986→	OE108	RN3C	0.6	8904	
	GS GG (GU71A)	1986→	OE108	RN3C	0.6	8904	
	GS GT-X (GS100G)	1986→	OE108	RN3C	0.6	8904	
	GSX E F	1980→	OE083	RA6HC	0.6	8809	SRO-5U
	GSX E G	1985→		RAX92YC	0.8	8809	SRO-5U
	GSX E, ES E, G	1986→		RAX92C	0.7	8809	SRO-5U
	GSX EFE,EFG,ESG,EG			RAX92C	0.6	8809	SRO-5U
	GSX ES F,EZ,ESD		OE083	RA6HC	0.9	8809	SRO-5U
	GSX F	1985→		RAX92C	0.6	8809	SRO-5U
	GSX FJ, FK (GV72C)	1988→		RAX92DC	0.7	8809	SRO-5U
	GSX FL, M (GV72C)	1985→		A59C	0.6		SRO-5U
	GSX G (GV72C)	1985→		A59C	0.6		SRO-5U
	GSX K I		OE092	RG4HC	0.7	8698	SRO-5U
	GSX L,M,T,X,ZD (GV74A)	1991→		RAX92DC	0.7	8809	SRO-5U
	GSX S, SZ Katana (GS1100XS)	1980→	OE083	RA6HC	0.6	8809	SRO-5U
	GSXR G-H (GU74C)	1986→1991		RAX92DC	0.7	8809	
	GSXR K (GU74C)	1986→1991		RAX92DC	0.7	8809	
GSXR L (GV73C)	1990→		RAX92DC	0.7	8809		
GSXR M-N (GV73C)	1990→		RAX92DC	0.7	8809		
GSXR W P,R,S,T (GU75C)	1993→	OE092	RG4HC	0.7	8698		
1150cc	GS EF E,G	1984→		RAX92C	0.7	8809	
	GS ES	1984→		RAX92C	0.6	8809	
	GSX E	→1985		RAX92C	0.7	8809	SRO-5U
	GSX E	1986→		RAX92YC	0.7	8809	SRO-5U
	GSX EF	1984→		RAX92C	0.7	8809	SRO-5U
	GSX ES	1984→		RAX92C	0.7	8809	SRO-5U
1200cc	GSF /S Bandit	2001→2005		RAX92DC	0.7	8809	
	GSF /S/SA Bandit	1996→2000		RAX92DC	0.7	8809	
	GSF Bandit	2006→		RAX92DC	0.7	8809	
	GSX		OE083	RA6HC	0.7	8809	
	GV GL F,G	1984→	OE083	RA6HC	0.7	8809	
1250cc	GSF Bandit	2007→		RG96C	0.6	8698	
1300cc	GSXR Hayabusa I (Fuel Injection)	1999→	OE092	RG4HC	0.8	8698	
1400cc	GSX	2001→		RG94C	0.7	8698	
	GV GC, GD, GT G, H, L	1986→		P-RA7HC	0.6	8812	
	VS GL H, J (VX51L)	1987→	OE083	RA6HC	0.9	8809	
	VS GLF, GLP Intruder Chopper L, M, N, P, R, S, T (VX51L)	1990→	OE083	RA6HC	0.9	8809	

**SUZUKI**

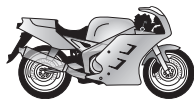
**21****POWER SPORT****...SUZUKI**

1500cc	VL Intruder	1998 → 2004	P-RA7HC	0.9	8812
	VL Intruder	2005 →	P-RA7HC	0.9	8812
1600cc	VZ Marauder	2004 →	RA8HC	0.9	8812
1800cc	VZR Intruder M R K6	2006 →	RG94C	0.9	8698

SV

35cc	Dakar 2/3		CJ8Y	0.5	
	Tricolor Mini Dakar		CJ8Y	0.5	

SVM

50cc	LA		OE037 L86C	0.6	
	TL Modified Minarelli Eng.		QN84	0.6	
	Trial Jumbo		OE091 RN2C	0.6	8904
125cc	Alpaca TL		OE045 RN11YCC	0.8	8405
	Explorer		OE108 RN3C	0.6	8904
	GP		OE108 RN3C	0.6	8904
	S3 Pioneer		C55	0.5	
	Touring		OE108 RN3C	0.6	8904

250cc	S3		QC57	0.5	
-------	----	--	------	-----	--

330cc	RL 329 MJ		OE045 RN11YCC	0.8	8405
-------	-----------	--	----------------------	-----	------

350cc	Explorer		OE083 RA6HC	0.5	8809
-------	----------	--	--------------------	-----	------

SWM

50cc	TL		QN84	0.5	
125cc	RG MD		QN84	0.5	
	RS GS		QN84	0.5	
	TF2		QN84	0.5	
	TF6		QN84	0.5	
	TL Alpaca		OE015 N12YC	0.8	8405
	TLM		OE015 N12YC	0.4	8405

175cc	RS GS		QN84	0.5	
-------	-------	--	------	-----	--

200cc	TL		OE015 N12YC	0.4	8405
-------	----	--	--------------------	-----	------

240cc	TL		OE015 N12YC	0.4	8405
-------	----	--	--------------------	-----	------

250cc	RS MC, GSL		QN84	0.5	
	TF 2		QN84	0.5	
	TF 6		QN84	0.5	
	Trial 240		OE015 N12YC	0.8	8405

320cc	TL, MTL Guanaco		OE015 N12YC	0.8	8405
	TLM		OE015 N12YC	0.4	8405

350cc	MCTF2		QN84	0.5	
	RS 347 GS		QN84	0.5	
	TL		OE015 N12YC	0.4	8405

370cc	MCTF2		QN84	0.5	
-------	-------	--	------	-----	--

400cc	MCTF2		QN84	0.5	
-------	-------	--	------	-----	--

SYM

50cc	Basix		OE064 RL82YC		8814
	Eurox		OE064 RL82YC		8814

125cc	Atila	1999 →	RZ96C	0.7	
	Husky (Air cooled)	2000 →	RG94C	0.7	8698
	Husky	1997 →	OE083 RA6HC	0.7	8809
	Joymax		RG94C		8698
	Super Duke	1999 →	RA8HC	0.6	8812
	Wolf	2005 →	OE083 RA6HC	0.7	8809

200cc	Joymax		RG94C		8698
-------	--------	--	-------	--	------

TAARNBY

	All models		OE037 L86C	0.5	
--	------------	--	-------------------	-----	--

**TAARNBY**

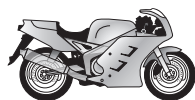
**21****POWER
SPORT****TAU MOTORI**

TVR 27 A, AL
TVR 27 V, VL
TVR 28

C55R
QN84
QN84

0.5
0.5
0.5

8814
8904

TECNOMOTO

50cc
Paciughino Standard, Special
Paciugo
TM 50 Z4
TM 50 Z6
TM 50 ZR

OE037 L86C
OE037 L86C
OE086 RL82C
OE108 RN3C
QN84

0.5
0.5
0.5
0.5
0.5

8814
8904

80cc
TM 80 Z6

OE086 RL82C

0.5

8814

TEMPO

50cc
Sprint 820
Sprint 820

L78C
QL55

0.5
0.5

8883

100cc
Auto
Corvette 290
Corvette 380
Fighter 220
Fighter 220
Fighter 230
Fighter 230
Panier 360
Saxonette

OE086 RL82C
OE086 RL82C
OE086 RL82C
L78C
QL55
L78C
QL55
OE086 RL82C
OE086 RL82C

0.5
0.5
0.5
0.5
0.5
0.5
0.5
0.5
0.5

8814
8814
8814
8883
8883
8883
8814
8814

TESTI

50cc
Amico (Minarelli V1)
Carabo CR (8.5PS)
Carabo(Minarelli P4A)
Carabo(Minarelli P6CS)
Carabo(Minarelli P6RAD)
Champion Special(Minarelli P6CS)
Champion Special(Minarelli P6RAD)
Champion(Minarelli P4/P6RAD)
Champion(Minarelli P4A/CS)
Champion(Minarelli P6A/CS)
Confort (Minarelli V1N)
Confort(Minarelli P3NK)
Corsa (8.5PS)
Criket (Minarelli V1AK/NK)
Criket(Minarelli P4A)
Criket(Minarelli P4CS/RAD)
Gran Prix(Minarelli P4A)
IO (Minarelli V1AKS)
Jeans(Minarelli P4/P6 RAD)
Mini Criket (Minarelli V1N/AK)
O.K.C. (Minarelli C2)
O.K.S. (Minarelli V1N)
Pull (Minarelli V1NK)

OE037 L86C
L78C
OE037 L86C
OE037 L86C
OE074 N5C
OE037 L86C
OE074 N5C
OE074 N5C
OE037 L86C
OE037 L86C
OE037 L86C
OE037 L86C
OE037 L86C
OE037 L86C
OE074 N5C
OE037 L86C
OE074 N5C
OE037 L86C
OE037 L86C
OE037 L86C
OE037 L86C
OE037 L86C
OE037 L86C

0.5
0.5
0.6
0.6
0.7
0.6
0.7
0.7
0.6
0.6
0.5
0.6
0.5
0.5
0.6
0.5
0.6
0.7
0.6
0.5
0.7
0.5
0.5
0.5

8883
8339
8339
8339
8883
8339
8339

80cc
Grand Touring (Minarelli)

L78C

0.5

8883

125cc
2000 Special
Corsa
Corsa Easy Rider

OE068 N3C
OE068 N3C
OE068 N3C

0.5
0.5
0.5

8904
8904
8904

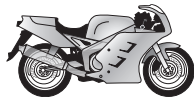
**21****POWER SPORT**

TGB							
50cc	202T	1998 →	OE064	RL82YC	0.8	8814	
	Ergon	1998 →	OE064	RL82YC	0.8	8814	
125cc	202T Palio	1998 →		Z9Y	0.7		
TGM							
50cc	Competition			QN84	0.5		
	Morini-Franco mot.		OE037	L86C	0.5		
125cc	Cross R, MX (Hiro mot.)			QN84	0.5		
250cc	Cross R, MX (Hiro mot.)			QN84	0.5		
TIANYI							
125cc	CG125			P-RA7HC		8812	
150cc	CG150			P-RA7HC		8812	
	GN			P-RG7C			
	GZ			P-RG7C			
TITAN							
1573cc	Coyote	1997 → 2003	OE004	RN9YCC	0.7	8415	
	Fat Bobber S&S engine		OE048	RN9YC4	1.1	8415	
	Gecko	1997 → 2003	OE004	RN9YCC	0.7	8415	
	Roadrunner	1997 → 2003	OE004	RN9YCC	0.7	8415	
	Scorpion	1997 → 2003	OE004	RN9YCC	0.7	8415	
	Sidewinder	1997 → 2003	OE004	RN9YCC	0.7	8415	
1753cc	Custom Pro Street S&S engine		OE048	RN9YC4	1.1	8415	
1852cc	Custom Rubber Mount Chopper S&S engine		OE048	RN9YC4	1.1	8415	
	Custom Softail Chopper S&S engine		OE048	RN9YC4	1.1	8415	
	Radical Rigid S&S engine		OE048	RN9YC4	1.1	8415	
2003cc	Custom Rubber Mount Chopper S&S engine			RA8HC	0.8	8812	
	Custom Softail Chopper S&S engine			RA8HC	0.8	8812	
	Radical Rigid S&S engine			RA8HC	0.8	8812	
TM							
80cc	GS Enduro	1994 →	OE040	N2C	0.6	8904	
	MC Cross	1994 →	OE040	N2C	0.6	8904	
125cc	EN	2003 →	OE091	RN2C	0.6	8904	
	GS Enduro	1994 →	OE040	N2C	0.6	8904	
	MC Cross	1994 →	OE040	N2C	0.6	8904	
250cc	Cross	1994 →	OE040	N2C	0.6	8904	
	EN	2003 →	OE108	RN3C	0.5	8904	
	EN F	2004 →		RG94C	0.7	8698	
	Enduro	1994 →	OE040	N2C	0.6	8904	
300cc	Cross	1994 →	OE040	N2C	0.6	8904	
	EN	2003 →	OE108	RN3C	0.5	8904	
	Enduro	1994 →	OE040	N2C	0.6	8904	
450cc	EN F	2004 →		RG94C	0.7	8698	
TOMOS							
49cc	14 TLC		OE086	RL82C	0.5	8814	
	14 TLS		OE086	RL82C	0.5	8814	
	14 VN			L78C	0.5	8883	
	15 SL			L78C	0.5	8883	
	15 SLC			L78C	0.5	8883	
	15 Sprint			L78C	0.5	8883	
	4H		OE037	L86C	0.5		
	APN 4		OE037	L86C	0.5		
	Automatic 3, 3K		OE037	L86C	0.5		
	Cross 50 Junior, Senior			L78C	0.5	8883	
	Forza		OE064	RL82YC	0.6	8814	

**TOMOS**

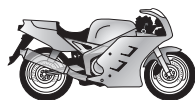
**21****POWER SPORT****...TOMOS**

...49cc	NT		OE037	L86C	0.5		
	Quadro 25		OE037	L86C	0.6		
	ST 50			L78C	0.5	8883	
	T12		OE037	L86C	0.5		
	VS 50			L78C	0.5	8883	
50cc	Tomos			L82C	0.5	8814	
	Tomos Cross			L78C	0.5	8883	
80cc	Tomos			L82C	0.5	8814	
90cc	Electronic			L78C	0.5	8883	

TORPADO

50cc	Derby Automatic		OE037	L86C	0.6		
	Derby Deluxe		OE037	L86C	0.5		
	Green		OE037	L86C	0.5		
	Green Deluxe		OE037	L86C	0.5		
	Squirrel Cross			L82C	0.5	8814	

TORROT

50cc	Ciclomatic/ 2VL			L82C	0.5	8814	
	City CX/N/SL/X			L82C	0.5	8814	
	City Lujo			L82C	0.5	8814	
	City Mini			L82C	0.5	8814	
	City TT			L82C	0.5	8814	
	City/L/2V/2V-TT			L82C	0.5	8814	
	Cycloscooter S50/HL			L82C	0.5	8814	
	Gran Cross			L82C	0.5	8814	
	Maxi			L82C	0.5	8814	
	Mini			L82C	0.5	8814	
	Mustang			L82C	0.5	8814	
	Panther			L82C	0.5	8814	
	Rally Sachs			L82C	0.5	8814	
	Sport 4V			L82C	0.5	8814	
	Sport Sachs TX50, TT50			L82C	0.5	8814	
	Super Cross			L82C	0.5	8814	
	Tiburón			L82C	0.5	8814	
	Trial			L82C	0.5	8814	
	TT 50			L82C	0.5	8814	
	Turismo			L82C	0.5	8814	

TOYOTA

	Bronco		OE037	L86C	0.5		
	City		OE037	L86C	0.5		
	GTS		OE037	L86C	0.5		
	HS 50		OE037	L86C	0.5		
	Starflite		OE037	L86C	0.5		
	Starflite VA		OE037	L86C	0.5		
	Tramp		OE037	L86C	0.5		

TRAILSPORT

	w/Tec. 3.5 h.p.			RJ17LM	0.8		
	w/Tec. 4 h.p.			RJ19LM	0.8		
	w/Tec. 5 h.p. OHV		OE098	RN4C	0.8	8339	

TRIMAK

50cc	Motocarro		OE037	L86C	0.5		
-------------	-----------	--	--------------	------	-----	--	--

TRIUMPH

125cc	Moto Meriden		OE108	RN3C	0.6	8904	
--------------	--------------	--	--------------	------	-----	-------------	--

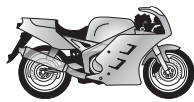

**21****POWER
SPORT****...TRIUMPH**

200cc	Tiger Cub T20 models		OE086	RL82C	0.6	8814	
250cc	Trophy		OE108	RN3C	0.6	8904	
500cc	Adventurer		OE108	RN3C	0.6	8904	
	Daytona T100		OE108	RN3C	0.6	8904	
	TR5 MX		OE108	RN3C	0.6	8904	
	TR5 T		OE108	RN3C	0.6	8904	
	Trophy		OE108	RN3C	0.6	8904	
600cc	Daytona	2003 →	OE092	RG4HC	0.7	8698	
	Speed Four	2002 →	OE092	RG4HC	0.7	8698	
	Speed Triple S	2002 →	OE092	RG4HC	0.7	8698	
	Supersport	2001 →	OE092	RG4HC	0.7	8698	
	TT	2000 →	OE092	RG4HC	0.7	8698	
650cc	Bonneville T120		OE078	N3G	0.6	8904	
	Daytona	2005 →	OE092	RG4HC	0.7	8698	
	Thunderbird TR65		OE078	N3G	0.6	8904	
	Tiger		OE078	N3G	0.6	8904	
	Trophy Sport TR6C		OE068	N3C	0.5	8904	
	Trophy TR6 (>029363)			L82C	0.5	8814	
	Trophy TR6 (029364>)		OE079	N4C	0.5	8339	
675cc	Daytona	2006 →	OE092	RG4HC	0.7	8698	
	Daytona RR	2006 →	OE092	RG4HC	0.7	8698	
	Speed Triple	2007 →	OE092	RG4HC	0.7	8698	
750cc	Bonneville T140D/E		OE074	N5C	0.6	8339	
	Bonneville T140V		OE078	N3G	0.6	8904	
	Daytona	1991 →		RAX92YC	0.9	8809	
	Hurricane TRX75	1973 →1978	OE068	N3C	0.6	8904	
	Speed Triple	1997 →	OE083	RA6HC	0.9	8809	
	Sprint RS	1999 →	OE083	RA6HC	0.9	8809	
	T 140 E, D			RN5C	0.6	8339	
	T 160		OE078	N3G	0.6	8904	
	Tiger TR7RV		OE078	N3G	0.6	8904	
	TR7T		OE078	N3G	0.6	8904	
	TR7V		OE078	N3G	0.6	8904	
	Trident	1991 →	OE083	RA6HC	0.9	8809	
	Trident T150V, T160		OE078	N3G	0.6	8904	
	Trident TR7RV, TR7V		OE078	N3G	0.6	8904	
	Triumph TSS Twin			G63	0.6		
790cc	America	2005 →	OE083	RA6HC	0.9	8809	
	Bonneville	2000 →	OE083	RA6HC	0.9	8809	
	Bonneville America	2002 →	OE083	RA6HC	0.9	8809	
	Bonneville T100	2002 →	OE083	RA6HC	0.9	8809	
	Speedmaster	2002 →	OE083	RA6HC	0.9	8809	
865cc	Scrambler 900	2006 →	OE083	RA6HC	0.9	8809	
	Thruxton 900	2004 →	OE083	RA6HC	0.9	8809	
885cc	Adventurer	1996 →	OE083	RA6HC	0.9	8809	
	Daytona 900	1993 →1996	OE083	RA6HC	0.9	8809	
	Daytona Super III	1994 →1996	OE083	RA6HC	0.9	8809	
	Legend TT	1998 →		RAX92YC	0.9	8809	
	Speed Triple	1994 →1996	OE083	RA6HC	0.9	8809	
	Speed Triple T509	1997 →	OE083	RA6HC	0.9	8809	
	Speedmaster America		OE083	RA6HC	0.9	8809	
	Sport	1998 →	OE083	RA6HC	0.9	8809	
	Sport Sprint 900	1997 →	OE083	RA6HC	0.9	8809	
	Sprint	1995 →	OE083	RA6HC	0.9	8809	
	Sprint 900	1993 →	OE083	RA6HC	0.9	8809	

**TRIUMPH**

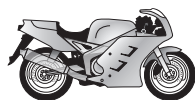
**21****POWER SPORT****...TRIUMPH**

...885cc	Sprint Executive	1998 →	OE083	RA6HC	0.9	8809	
	Sprint ST	1999 →	OE083	RA6HC	0.9	8809	
	Thunderbird	1995 →	OE083	RA6HC	0.9	8809	
	Thunderbird Sport	1998 →2000	OE083	RA6HC	0.9	8809	
	Tiger	1999 →	OE083	RA6HC	0.9	8809	
	Tiger 900	1993 →1998	OE083	RA6HC	0.9	8809	
	Trident	1991 →	OE083	RA6HC	0.9	8809	
	Trophy	1991 →1995	OE083	RA6HC	0.9	8809	
	Trophy	1996 →	OE083	RA6HC	0.9	8809	
955cc	Daytona	2002 →	OE092	RG4HC	0.6	8698	
	Daytona	1999 →2001	OE083	RA6HC	0.8	8809	
	Speed Triple	2002 →	OE092	RG4HC	0.6	8698	
	Sprint RS	2002 →	OE092	RG4HC	0.6	8698	
	Sprint ST	2002 →	OE092	RG4HC	0.6	8698	
	Tiger	2001 →	OE083	RA6HC	0.8	8809	
956cc	Daytona T595	1997 →	OE083	RA6HC	0.8	8809	
	Speed Triple	1999 →2001	OE083	RA6HC	0.8	8809	
	Sprint ST	1999 →2001	OE083	RA6HC	0.8	8809	
1000cc	Daytona	1991 →1993		RAX92YC	0.9	8809	
1050cc	Speed Triple	2005 →	OE092	RG4HC	0.6	8698	
	Sprint ST	2005 →	OE092	RG4HC	0.6	8698	
	Tiger	2006 →	OE092	RG4HC	0.6	8698	
1180cc	Trophy	1991 →		RAX92YC	0.9	8809	
1200cc	Daytona	1993 →		RAX92YC	0.9	8809	
	Thunderbird	1995 →		RAX92YC	0.9	8809	
	Tiger	1992 →		RAX92YC	0.9	8809	
	Trophy	1991 →		RAX92YC	0.9	8809	
2300cc	Rocket III Twinspark	2005 →	OE083	RA6HC	0.9	8809	

TUNTURI

50cc	VS 50 (Puch mot.)		OE037	L86C	0.5		
	VZ 50 (Puch mot.)		OE037	L86C	0.5		
	VZ 50 N4 (Puch mot.)		OE037	L86C	0.5		

URAL

648cc	Deco Cruiser	1998 →	OE059	L92YC	0.6		
	Italia Cruiser	1998 →	OE059	L92YC	0.6		
	Solo Cruiser	1998 →	OE059	L92YC	0.6		
	Sportsman Classic	1997 →	OE059	L92YC	0.6		
	Tourist Classic	1997 →	OE059	L92YC	0.6		
650cc	IMZ-10		OE059	L92YC	0.6		
	IMZ-40		OE059	L92YC	0.6		
	IMZ-50		OE059	L92YC	0.6		
	M3-8.103		OE059	L92YC	0.5		
	M3-8.123		OE001	N9YC	0.7	8415	
	Solo Single	1994 →1996	OE059	L92YC	0.6		
	Sportsman	1994 →1996	OE059	L92YC	0.6		
	Tourist Sidcar	1994 →1996	OE059	L92YC	0.6		
750cc	Tourist			L82C	0.5	8814	

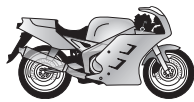
**21****POWER
SPORT****URAL AMERICA**

650cc	Bavarian Classic	1999 →	OE038	L82YC	0.7	8814	
	Deco Classic	1997 → 1998	OE038	L82YC	0.7	8814	
	Deco Classic	1999 →	OE038	L82YC	0.7	8814	
	Deco Cruiser	1998 →	OE038	L82YC	0.7	8814	
	Italia Cruiser	1994 → 1997	OE038	L82YC	0.7	8814	
	Italia Cruiser II	1998 →	OE038	L82YC	0.7	8814	
	Patrol Classic	1999 →	OE038	L82YC	0.7	8814	
	Solo Classic	1999 →	OE038	L82YC	0.7	8814	
	Solo Cruiser	1998 →	OE038	L82YC	0.7	8814	
	Solo Single	1994 → 1997	OE038	L82YC	0.7	8814	
	Sportsman	1994 → 1996	OE038	L82YC	0.7	8814	
	Sportsman Classic	1997 → 1998	OE038	L82YC	0.7	8814	
	Tourist Classic	1997 → 1998	OE038	L82YC	0.7	8814	
	Tourist Classic	1999 →	OE038	L82YC	0.7	8814	
Tourist Sidecar	1994 → 1997	OE038	L82YC	0.7	8814		

VALENTI

80cc	CR 80W Cross		OE125	N2G	0.5	8904	
-------------	--------------	--	--------------	-----	-----	-------------	--

VAP

	All models		OE037	L86C	0.5		
--	------------	--	--------------	------	-----	--	--

VELOCETTE

200cc	LE			Z9Y	0.5		
	Valiant			Z9Y	0.5		
	Vogue			Z9Y	0.5		
350cc	Endurance		OE108	RN3C	0.5	8904	
	MAC			RN5C	0.5	8339	
	MAC Iron head		OE007	L87YC	0.5		
	Scrambler		OE108	RN3C	0.5	8904	
	Viper Special, Clubman		OE098	RN4C	0.5	8339	
500cc	MSS	1954 →		RN5C	0.5	8339	
	Scrambler		OE108	RN3C	0.5	8904	
	Thruyton		OE108	RN3C	0.5	8904	
	Vee-line		OE108	RN3C	0.5	8904	
	Venom		OE108	RN3C	0.5	8904	

VELOSOLEX

49cc	2200		OE037	L86C	0.5		
	3300		OE037	L86C	0.5		
	3800		OE037	L86C	0.5		
	8000			RN5C	0.6	8339	
	5000 Flash		OE037	L86C	0.5		
	6000 Flash		OE037	L86C	0.5		
	Micron		OE037	L86C	0.5		
	Pli-solex		OE037	L86C	0.5		
	Tenor			RN5C	0.6	8339	
	Velosolex		OE037	L86C	0.5		

VERTEMATI

503cc	E 450		OE092	RG4HC	0.7	8698	
	E 450 E		OE092	RG4HC	0.7	8698	
	E 501		OE092	RG4HC	0.7	8698	
	E 501 E		OE092	RG4HC	0.7	8698	
	E 570		OE092	RG4HC	0.7	8698	
	E 570 E		OE092	RG4HC	0.7	8698	

**VERTEMATI**

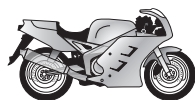
**21****POWER
SPORT****VESPA (→ Piaggio, Moto Vespa)****VICOPEL**

All models

OE037 L86C 0.5**VICTORY****1500cc**

8-Ball	2005→	RG6YCA	0.9	
Classic Cruiser	2003→	RG6YCA	0.9	
Cruiser	1998→2001	RA8HC	1.0	8812
Cruiser	2002→	RG6YCA	0.9	
Hammer	2005→	RG6YCA	0.9	
Kingpin	2004→2005	RG6YCA	0.9	
Kingpin Ness Signature	2005→	RG6YCA	0.9	
Spezial Edition	2000→	RA8HC	1.0	8812
Sport Cruiser	2000→2001	RA8HC	1.0	8812
Standard Cruiser	1999→2002	RA8HC	1.0	8812
Touring Cruiser	2000→2001	RA8HC	1.0	8812
Touring Cruiser	2002→2005	RG6YCA	0.9	
Vegas	2003→2005	RG6YCA	0.9	
Vegas ANSS	2004→	RG6YCA	0.9	
Vegas Ness Signature	2005→	RG6YCA	0.9	

1634cc

Hammer 100cu in Freedom	2006→	RG6YCA	0.9	
Ness Signature Jackpot 100cu in Freedom	2006→	RG6YCA	0.9	
Touring Cruiser 100cu in Freedom	2006→	RG6YCA	0.9	
Vegas 100cu in Freedom	2006→	RG6YCA	0.9	
Vegas 8-Ball 100cu in Freedom	2006→	RG6YCA	0.9	
Vegas Jackpot 100cu in Freedom	2006→	RG6YCA	0.9	

VILLIERS**122cc**

10D		OE037 L86C	0.5	
11D		OE086 RL82C	0.5	8814
12D		OE037 L86C	0.5	
13D		OE037 L86C	0.5	
8 D		OE037 L86C	0.5	
9D		OE037 L86C	0.5	

147cc

29C		OE086 RL82C	0.5	8814
30C (Fan cooled)		OE086 RL82C	0.5	8814
30C		OE086 RL82C	0.5	8814

148cc

Mk XXXI C		OE086 RL82C	0.5	8814
-----------	--	--------------------	-----	------

173cc

2L		OE086 RL82C	0.5	8814
3 L		OE086 RL82C	0.5	8814

197cc

11E		OE086 RL82C	0.5	8814
1E		OE086 RL82C	0.5	8814
6 E		OE086 RL82C	0.5	8814
7 E		OE086 RL82C	0.5	8814
8 E		OE086 RL82C	0.5	8814
9E		OE086 RL82C	0.5	8814

225cc

1H		OE086 RL82C	0.5	8814
----	--	--------------------	-----	------

VESPA (→ Piaggio, Moto Vespa)

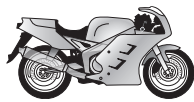
**21****POWER
SPORT****...VILLIERS**

246cc	2H		OE037	L86C	0.5		
	31A 3S		OE086	RL82C	0.5	8814	
	31A 4S		OE086	RL82C	0.5	8814	
	32A		OE086	RL82C	0.5	8814	
	33A		OE108	RN3C	0.5	8904	
	34A		OE108	RN3C	0.5	8904	
	35A		OE086	RL82C	0.5	8814	
	36A		OE108	RN3C	0.5	8904	
	37A		OE086	RL82C	0.5	8814	

249cc	2T		OE037	L86C	0.5		
--------------	----	--	--------------	------	-----	--	--

250cc	4T		OE086	RL82C	0.5	8814	
--------------	----	--	--------------	-------	-----	------	--

325cc	3T		OE086	RL82C	0.5	8814	
--------------	----	--	--------------	-------	-----	------	--

350cc	28B		OE086	RL82C	0.5	8814	
--------------	-----	--	--------------	-------	-----	------	--

VINCENT

500cc	Comet			RN5C	0.5	8339	
--------------	-------	--	--	------	-----	------	--

1000cc	Black Shadow			RN5C	0.5	8339	
---------------	--------------	--	--	------	-----	------	--

	Rapide			RN5C	0.5	8339	
--	--------	--	--	------	-----	------	--

VOR

400cc	EN Enduro	2000 →		RG94C	0.6	8698	
--------------	-----------	--------	--	-------	-----	------	--

	ENE	2004 →		RG94C	0.6	8698	
--	-----	--------	--	-------	-----	------	--

	EN-MAR	2004 →		RG94C	0.6	8698	
--	--------	--------	--	-------	-----	------	--

	MX Cross	2000 →		RG94C	0.6	8698	
--	----------	--------	--	-------	-----	------	--

	SM Super Moto	2000 →		RG94C	0.6	8698	
--	---------------	--------	--	-------	-----	------	--

	SM Super Moto Competition	2000 →		RG94C	0.6	8698	
--	---------------------------	--------	--	-------	-----	------	--

503cc	EN Enduro	1999 →		RG94C	0.6	8698	
--------------	-----------	--------	--	-------	-----	------	--

	MX Cross	1999 →		RG94C	0.6	8698	
--	----------	--------	--	-------	-----	------	--

	SM Super Moto	1999 →		RG94C	0.6	8698	
--	---------------	--------	--	-------	-----	------	--

	SM Super Moto Competition	1999 →		RG94C	0.6	8698	
--	---------------------------	--------	--	-------	-----	------	--

530cc	ENE	2004 →		RG94C	0.6	8698	
--------------	-----	--------	--	-------	-----	------	--

	EN-MAR	2004 →		RG94C	0.6	8698	
--	--------	--------	--	-------	-----	------	--

	Super Motard Com.	2000 →		RG94C	0.6	8698	
--	-------------------	--------	--	-------	-----	------	--

VOSKHOD (→ Cossack)**VOXAN**

996cc	Café Racer V2	1999 →		C63YC			
--------------	---------------	--------	--	-------	--	--	--

	Roadster V72 V2	1998 →		C63YC			
--	-----------------	--------	--	-------	--	--	--

	Scrambler V2	2000 →		C63YC			
--	--------------	--------	--	-------	--	--	--

VYRUS

992cc	984 C3 2V Ducati	2003 →	OE073	RA4HC			
--------------	------------------	--------	--------------	-------	--	--	--

999cc	985 C3 4V Ducati	2006 →	OE092	RG4HC		8698	
--------------	------------------	--------	--------------	-------	--	------	--

WESLAKE

500cc	Longtrack (Pushrod)			G55R	0.5		
--------------	---------------------	--	--	------	-----	--	--

	Longtrack			G55R	0.5		
--	-----------	--	--	------	-----	--	--

	Longtrack			G55R	0.5		
--	-----------	--	--	------	-----	--	--

	Speedway (Pushrod)			G57R	0.5		
--	--------------------	--	--	------	-----	--	--

	Speedway			G57R	0.5		
--	----------	--	--	------	-----	--	--

	Speedway			G57R	0.5		
--	----------	--	--	------	-----	--	--

WSK

125cc	All models		OE086	RL82C	0.5	8814	
--------------	------------	--	--------------	-------	-----	------	--

175cc	All models		OE086	RL82C	0.5	8814	
--------------	------------	--	--------------	-------	-----	------	--

**WSK**

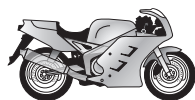
**21****POWER
SPORT****YAMAHA****50cc**

CA E, M, N Salient Roller (14T)	1983 → 1988	OE007	L87YC	0.8		PRO-5M
CE E		OE007	L87YC	0.8		PRO-5M
CH E, ET		OE064	RL82YC	0.8	8814	PRO-5M
Chappy	1980 →	OE037	L86C	0.6		
CV		OE007	L87YC	0.8		PRO-5M
CY	1993 →	OE064	RL82YC	0.8	8814	PRO-5M
CY E, F	1994 →	OE064	RL82YC	0.8	8814	PRO-5M
DT A (2M4)	1978 → 1988		RL86C	0.6		PRO-5M
DT E	1993 →	OE108	RN3C	0.6	8904	PRO-5M
DT F	1994 →	OE108	RN3C	0.6	8904	
DT LC	1993 →	OE108	RN3C	0.6	8904	PRO-5M
DT M (2M4)	1978 → 1988	OE037	L86C	0.8		PRO-5M
DT MC	1986 → 1993	OE086	RL82C	0.6	8814	PRO-5M
DT MX (13N)	1980 → 1986	OE086	RL82C	0.6	8814	PRO-5M
DT MX (1NN)	1984 → 1990	OE086	RL82C	0.6	8814	PRO-5M
DT MX, S (5T8)	1986 → 1993	OE086	RL82C	0.6	8814	PRO-5M
DT R	1991 → 1995	OE086	RL82C	0.6	8814	PRO-5M
DT R (3MW)	1990 →	OE086	RL82C	0.6	8814	PRO-5M
DT R	1997 →	OE091	RN2C	0.6	8904	PRO-5M
DT R			RL86C	0.6		PRO-5M
DT RM	1997 →	OE108	RN3C	0.7	8904	PRO-5M
DX R	1997 →	OE108	RN3C	0.7	8904	
DX S	1992 →	OE086	RL82C	0.6	8814	
ES			L78C	0.6	8883	PRO-5M
Fizz	1995 →		RL78C	0.7	8883	PRO-5M
FS 1 E, F, H, HB, K, KF, F, P, S, SE (3F2)	1978 → 1984		RL86C	0.6		PRO-5M
FS 1 F-DX, H-DX, S-DX		OE086	RL82C	0.6	8814	PRO-5M
FS 3 3M			L78C	0.6	8883	PRO-5M
FT 1		OE086	RL82C	0.6	8814	
GT B, D		OE086	RL82C	0.6	8814	PRO-5M
LB 2 -80 Chopper (551)	1981 → 1988	OE007	L87YC	0.8		PRO-5M
LB 2 M Chopper (551)	1981 → 1988	OE086	RL82C	0.6	8814	PRO-5M
LB 3		OE007	L87YC	0.8		PRO-5M
LB 3 -80			RL86C	0.6		PRO-5M
LB Chappy		OE037	L86C	0.6		PRO-5M
LC H, M, N		OE059	L92YC	0.6		PRO-5M
MA ,M		OE059	L92YC	0.6		PRO-5M
MBK Magnum	1990 →	OE091	RN2C	0.6	8904	PRO-5M
Meyami	1986 →	OE086	RL82C	0.6	8814	
MR , H		OE086	RL82C	0.6	8814	PRO-5M
PW		OE059	L92YC	0.6		PRO-5M
PW E, H, J, K, L, M, S (3PT)		OE059	L92YC	0.6		PRO-5M
PW H, F	1993 →	OE059	L92YC	0.6		PRO-5M
QT , H		OE059	L92YC	0.6		PRO-5M
RD DX	1973 → 1975		L78C	0.7	8883	PRO-5M
RD H (13M)	1980 → 1987	OE086	RL82C	0.6	8814	PRO-5M
RD MX (2E0)	1977 → 1986	OE037	L86C	0.8		PRO-5M
RZ K, L		OE007	L87YC	0.8		
S			RL86C	0.6		
S-II		OE059	L92YC	0.6		
SA , H, M		OE059	L92YC	0.6		PRO-5M
SB		OE059	L92YC	0.6		
SG (34N)	1983 → 1987	OE064	RL82YC	0.8	8814	PRO-5M
SH E, ED, MF	1993 →	OE007	L87YC	0.8		PRO-5M

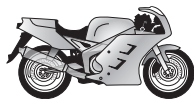
**21****POWER
SPORT****...YAMAHA****...50cc**

SH F		OE007	L87YC	0.8		PRO-5M
SH Mint		OE007	L87YC	0.8		PRO-5M
T			Z9Y	0.7		PRO-5M
TDR		OE108	RN3C	0.6	8904	
TY M (1GR)	1977→1983	OE037	L86C	0.8		PRO-5M
TZR		OE091	RN2C	0.6	8904	
V D, E	1993→	OE086	RL82C	0.6	8814	PRO-5M
V M	1984→		RN5C	0.6	8339	PRO-5M
V M	1981→1983	OE038	L82YC	0.6	8814	PRO-5M
V M	→1980	OE037	L86C	0.8		PRO-5M
Yamy		OE086	RL82C	0.5	8814	
YB S		OE086	RL82C	0.6	8814	PRO-5M
YE Roller Zest (4FW)	1993→	OE086	RL82C	0.6	8814	PRO-5M
YM (4RC)	1994→		QL78C	0.6	8883	
YQ Aerox R (Liquid cooled)	2000→		QL77JC4		8883	
YSR C Roller	1989→1993		L78C	0.6	8883	
YZ, H		OE091	RN2C	0.6	8904	PRO-5M
Zuma (CW50-J/K)	1996→		QL78C	0.5	8883	

60cc

JT 1 L		OE086	RL82C	0.6	8814	
JT 2 M		OE086	RL82C	0.6	8814	
RD		OE086	RL82C	0.6	8814	PRO-5M
YB		OE086	RL82C	0.6	8814	PRO-5M
YT N, S		OE007	L87YC	0.8		
YTM L		OE007	L87YC	0.8		
YZ KL, H, J (Racing)		OE108	RN3C	0.6	8904	PRO-5M

65cc

BWS	1992→	OE086	RL82C	0.6	8814	
CW	1992→	OE086	RL82C	0.6	8814	PRO-5M

70cc

Mate		OE086	RL82C	0.6	8814	
V		OE086	RL82C	0.6	8814	

75cc

RD LC		OE108	RN3C	0.6	8904	
V A		OE086	RL82C	0.6	8814	
Y		OE007	L87YC	0.8		

80cc

Active	1990→	OE064	RL82YC	0.8	8814	PRO-5M
BW S, T, U, W		OE086	RL82C	0.6	8814	
CH	1990→	OE064	RL82YC	0.8	8814	
CJ E		OE086	RL82C	0.6	8814	
CV E, EV, J, K, N, S, T		OE064	RL82YC	0.8	8814	PRO-5M
DT (5J1)	1981→1985		QL78C	0.6	8883	PRO-5M
DT J, K, M		OE086	RL82C	0.5	8814	PRO-5M
DT LC		OE086	RL82C	0.6	8814	PRO-5M
DT LC, I		OE091	RN2C	0.7	8904	PRO-5M
DT LC, II (37A)	1983→1986	OE108	RN3C	0.6	8904	PRO-5M
DT MK-5 (53V)	1984→	OE091	RN2C	0.6	8904	PRO-5M
DT MkII (5T8)	1983→1986		QL78C	0.6	8883	PRO-5M
DT MX		OE037	L86C	0.8		PRO-5M
FS SE (5A7)	1981→1983	OE086	RL82C	0.6	8814	PRO-5M
GT D D, E		OE086	RL82C	0.6	8814	PRO-5M
LB		OE007	L87YC	0.7		PRO-5M
LB 2, 2A, 2AC, 2AD, H, HD		OE037	L86C	0.8		PRO-5M
LB -3 Mini Bike		OE037	L86C	0.8		PRO-5M
LB 3D		OE037	L86C	0.8		PRO-5M
MX H		OE037	L86C	0.8		PRO-5M
NX, H, J		OE086	RL82C	0.6	8814	
PW (2VF)	1991→	OE091	RN2C	0.6	8904	PRO-5M

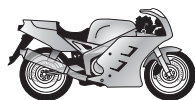

**21****POWER
SPORT****...YAMAHA****...80cc**

PW (4BC)	1993 →	OE007	L87YC	0.8		PRO-5M
PW E, F (21W)	1983 → 1990	OE064	RL82YC	0.8	8814	PRO-5M
RD LC (10X)	1980 → 1986	OE108	RN3C	0.6	8904	PRO-5M
RD LC-II (30W)	1980 → 1990	OE108	RN3C	0.6	8904	PRO-5M
RD MX (5G1)	1981 → 1985		L78C	0.6	8883	PRO-5M
RX SE, SP (12N)	1982 → 1985		L78C	0.6	8883	PRO-5M
T Townmate			Z6	0.6		PRO-5M
TDR		OE108	RN3C	0.6	8904	
TG 1 D, K, KS, T			L78C	0.6	8883	
TY	1983 →	OE086	RL82C	0.6	8814	PRO-5M
TZR		OE108	RN3C	0.7	8904	
V DL, E, ED, H, D		OE007	L87YC	0.8		PRO-5M
Y, E		OE007	L87YC	0.8		PRO-5M
YB		OE086	RL82C	0.6	8814	PRO-5M
YSR			RL78C	0.6	8883	
YZ	1990 →	OE091	RN2C	0.6	8904	PRO-5M
YZ	1993 →		QN84	0.6		PRO-5M
YZ (L 12.7mm/1/2in.) (Racing)	→ 1984		L78C	0.6	8883	PRO-5M
YZ B			L78C	0.6	8883	PRO-5M
YZ C, D, E, H	→ 1992	OE068	N3C	0.6	8904	PRO-5M
YZ E, F, LW, LWF	1993 →	OE040	N2C	0.6	8904	PRO-5M
YZ HR			L82C	0.7	8814	PRO-5M
YZ LC (3NL)		OE108	RN3C	0.6	8904	PRO-5M
YZ LR		OE068	N3C	0.6	8904	PRO-5M
YZ SW/WF	1980 → 1986		QN86	0.6		PRO-5M

85cc

YZ85	2003 →		QN84	0.6		
------	--------	--	------	-----	--	--

90cc

CR		OE064	RL82YC	0.8	8814	
HS 1			L78C	0.6	8883	
MK			QN84	0.6		
TT R (Air cooled)	2000 →		P-RZ9HC	0.7		
V		OE064	RL82YC	0.8	8814	
YA		OE086	RL82C	0.6	8814	PRO-5M

100cc

AG		OE079	N4C	0.6	8339	PRO-5M
AG H, E, F	→ 1980	OE086	RL82C	0.6	8814	PRO-5M
BWS	2000 →	OE064	RL82YC	0.7	8814	
DT		OE079	N4C	0.8	8339	PRO-5M
DT B			L78C	0.7	8883	PRO-5M
DT C, X		OE079	N4C	0.8	8339	PRO-5M
DT D, E, H, SD		OE068	N3C	0.6	8904	PRO-5M
DX, H			L82C	0.6	8814	PRO-5M
MX B		OE068	N3C	0.6	8904	PRO-5M
MX, H		OE079	N4C	0.6	8339	PRO-5M
NX B		OE068	N3C	0.6	8904	
RS B, S, X			L78C	0.6	8883	PRO-5M
RS DX (1YB)			L78C	0.6	8883	PRO-5M
RS P		OE007	L87YC	0.8		PRO-5M
RT A,E,F,G, H,J,K,L (Air cooled)	1993 →	OE098	RN4C	0.6	8339	PRO-5M
RT E, F	1993 →	OE079	N4C	0.6	8339	PRO-5M
RX 12.7mm/1/2in.			L78C	0.6	8883	PRO-5M
RX 19mm/3/4in.		OE108	RN3C	0.6	8904	PRO-5M
RXS			QL78C	0.6	8883	PRO-5M
RXZ 19mm/3/4in.		OE108	RN3C	0.6	8904	PRO-5M
RXZ D	1993 →	OE008	RN7YCC	0.8	8332	PRO-5M
V E, S, SAH	1993 →	OE064	RL82YC	0.8	8814	PRO-5M

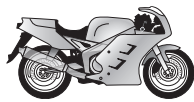
**21****POWER
SPORT****...YAMAHA**

...100cc	WR	1997→	OE091	RN2C	0.6	8904	
	YB			L78C	0.6	8883	PRO-5M
	YB M, P	1994→	OE064	RL82YC	0.8	8814	PRO-5M
	YFM			Z9Y	0.6		
	YZ E, H			QN84	0.6		PRO-5M
110cc	V	1993→	OE064	RL82YC	0.8	8814	PRO-5M
115cc	RX	1993→	OE064	RL82YC	0.8	8814	PRO-5M
120cc	V C JR, ZR (Racing)	1994→	OE008	RN7YCC	0.8	8332	PRO-5M
125cc	CT C, J, K, L	1982→1984	OE073	RA4HC	0.6		
	Cygnus R [F] XC125T, XC125R	1996→		RG96C	0.7	8698	
	Cygnus XC125T, XC125R	1996→		RG96C	0.7	8698	
	CZ		OE084	N6YCC	0.8	8902	
	DT (Liquid cooled) (3RM)	1991→	OE091	RN2C	0.6	8904	PRO-5M
	DT E, F, H, ED, K, J		OE108	RN3C	0.6	8904	PRO-5M
	DT LC, X, Tenere		OE108	RN3C	0.6	8904	PRO-5M
	DT MX	1982→1986	OE108	RN3C	0.6	8904	PRO-5M
	DT R	→1981		L78C	0.6	8883	PRO-5M
	DT R (4BL)	1995→	OE091	RN2C	0.6	8904	PRO-5M
	DT RE	2004→	OE108	RN3C	0.6	8904	PRO-5M
	IT H, J			QN86	0.6		PRO-5M
	MK			QN86	0.6		
	MX		OE078	N3G	0.6	8904	PRO-5M
	R SE		OE064	RL82YC	0.8	8814	PRO-5M
	RD C, C-DX		OE108	RN3C	0.6	8904	PRO-5M
	RD LC (10W)	1981→1986	OE091	RN2C	0.6	8904	PRO-5M
	RD, D-DX 12.7mm/1/2in.			L78C	0.6	8883	PRO-5M
	RS		OE064	RL82YC	0.8	8814	PRO-5M
	RS DX, Z		OE108	RN3C	0.6	8904	PRO-5M
	RS DX, Z 12.7mm/1/2in.			L78C	0.6	8883	PRO-5M
	RS E			L78C	0.6	8883	PRO-5M
	RS P			L82C	0.6	8814	PRO-5M
	RS P		OE064	RL82YC	0.8	8814	PRO-5M
	RT SE		OE108	RN3C	0.6	8904	PRO-5M
	RX 19mm/3/4in.		OE108	RN3C	0.6	8904	PRO-5M
	RX H 12.7mm/1/2in.			L78C	0.6	8883	PRO-5M
	SR (Air cooled)		OE083	RA6HC	0.7	8809	
	SR Z (Air cooled)		OE083	RA6HC	0.7	8809	
	TA A			QN84	0.6		PRO-5M
	TDR (4GW)	1992→	OE091	RN2C	0.6	8904	PRO-5M
	TT-R LW (Air cooled)	2000→		RZ96C	0.7		
	TW (Air cooled)	1999→	OE083	RA6HC	0.9	8809	
	TY 12,7mm/1/2in.		OE086	RL82C	0.6	8814	PRO-5M
	TY 19mm/3/4in.		OE098	RN4C	0.6	8339	PRO-5M
	TZ (Racing) (3V3)	1980→		QN84	0.6		PRO-5M
	TZ (4JT), F (Racing)	1994→		QN84	0.6		PRO-5M
	TZ H (Racing) (3EV)	1993→		QN84	0.6		PRO-5M
	TZR (Racing)	1993→	OE091	RN2C	0.6	8904	PRO-5M
	TZR		OE091	RN2C	0.7	8904	PRO-5M
	TZR (Racing)	1993→		QN84	0.6		PRO-5M
	XT J, K, KC, L		OE083	RA6HC	0.7	8809	PRO-5M
	XT R, X	2005→		RZ96C	0.7		PRO-5M
	XV Virago V Twin (Air cooled) (5AJ)	1997→		Z9Y	0.6		
	XVS Dragstar (Air cooled)	2000→		RZ96C	0.7		
	YB		OE086	RL82C	0.6	8814	PRO-5M

**YAMAHA**

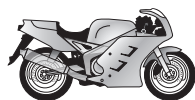
**21****POWER SPORT****...YAMAHA**

Capacity	Model	Year	Part No.	Gap (mm)	Part No.	Notes
...125cc	YBR	2005 →	P-RZ9HC	0.7		
	YFA F, W	1994 →	RZ96C	0.7		
	YS		OE040 N2C	0.6	8904	PRO-5M
	YZ	→1984	QN86	0.6		PRO-5M
	YZ B, C, E, H, X	1982 →	QN84	0.6		PRO-5M
	YZ E1, F, LC	1985 →1989	QN86	0.6		PRO-5M
	YZ LC	1993 →	QN84	0.6		PRO-5M
	YZ T	1990 →	QN86	0.6		PRO-5M
135cc	RXK		OE064 RL82YC	0.8	8814	
	RXZ		OE084 N6YCC	0.8	8902	
150cc	CZ R		OE010 N7YC	0.8	8332	
	FZ	1994 →	RZ96C	0.7		
	FZR	1994 →	RZ96C	0.7		
	RX	1993 →	OE008 RN7YCC	0.8	8332	PRO-5M
	SR	1993 →	OE083 RA6HC	0.7	8809	
165cc	DT R		OE108 RN3C	0.6	8904	PRO-5M
175cc	AG		OE098 RN4C	0.6	8339	PRO-5M
	AG H, J, K		OE108 RN3C	0.6	8904	PRO-5M
	DT, E, F, MX	1980 →	OE040 N2C	0.6	8904	PRO-5M
	DT H	1980 →	OE068 N3C	0.6	8904	PRO-5M
	IT	→1981	QN86	0.6		PRO-5M
	IT E (5Y0)	1982 →1985	QN86	0.6		PRO-5M
	IT H	1982 →	QN84	0.6		PRO-5M
	MX, B, H		OE108 RN3C	0.6	8904	PRO-5M
	TY E, J (Racing)		OE098 RN4C	0.6	8339	PRO-5M
	YZ		QN84	0.6		PRO-5M
180cc	RT E	1993 →	OE108 RN3C	0.6	8904	PRO-5M
	RX		L77JC4	1.0	8883	
	XC Cygnus Roller (32H)	1984 →1988	OE083 RA6HC	0.9	8809	
185cc	SH H	1983 →1984	P-RA7HC	0.7	8812	
	SR H, J		OE083 RA6HC	0.6	8809	
195cc	RS		OE098 RN4C	0.6	8339	PRO-5M
200cc	AG E, F	1993 →	OE083 RA6HC	0.7	8809	
	BW ET, EU, N, S		OE083 RA6HC	0.7	8809	
	DT LC, RF, RE	1993 →	OE091 RN2C	0.6	8904	PRO-5M
	DT R		OE091 RN2C	0.6	8904	PRO-5M
	IT L, M		OE091 RN2C	0.6	8904	PRO-5M
	IT S		QC59C	0.6		PRO-5M
	NR		OE098 RN4C	0.6	8339	PRO-5M
	RD		OE108 RN3C	0.6	8904	PRO-5M
	RD (L 12.7mm/1/2in.)		L78C	0.6	8883	PRO-5M
	RD C, D, C-DX, S, DX		OE098 RN4C	0.6	8339	PRO-5M
	RS	→1981	L78C	0.6	8883	PRO-5M
	RS 12.7mm/1/2in.	1982 →	OE108 RN3C	0.6	8904	PRO-5M
	TW		OE083 RA6HC	0.7	8809	
	TW E, EC, F	1987 →	OE083 RA6HC	0.7	8809	
	TW FC	1993 →	OE083 RA6HC	0.7	8809	
	TW U, W, WC	1994 →	OE083 RA6HC	0.7	8809	
	WR R, RF, RE	1993 →	OE091 RN2C	0.6	8904	PRO-5M
	XCT, U, W, ZT, ZW		P-RA7HC	0.9	8812	
	XT JK, KC		OE083 RA6HC	0.7	8809	
	YT N		OE083 RA6HC	0.7	8809	
YTM ERN, N		P-RA7HC	0.7	8812		
YTM K, EK, L, EL		P-RA7HC	0.7	8812		
YTM S		P-RA7HC	0.7	8812		

**YAMAHA**

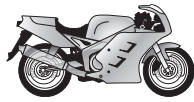

21



POWER
SPORT



...YAMAHA

225cc	XT E, EC, F, FC YFU1	1993→	OE083	RA6HC P-RA7HC	0.7 0.7	8809 8812	
230cc	YFU1			P-RA7HC	0.7	8812	
240cc	TDR XV Virago		OE091	RN2C P-RZ9HC	0.6 0.7	8904	PRO-5M
250cc	DT E, H		OE108	RN3C	0.6	8904	PRO-5M
	DT MX (1R7)	1981→1986	OE108	RN3C	0.6	8904	PRO-5M
	DTR		OE091	RN2C	0.6	8904	
	IT			QN84	0.6		PRO-5M
	IT			QN86	0.6		PRO-5M
	IT H, J, K (4V5)	1981→	OE108	RN3C	0.6	8904	PRO-5M
	IT N (45J)	1985→		QN86	0.6		PRO-5M
	MX		OE108	RN3C	0.6	8904	PRO-5M
	R1Z	1993→	OE091	RN2C	0.6	8904	
	RD 12.7mm/1/2in.			L78C	0.6	8883	PRO-5M
	RD 19mm/3/4in. (4L1)	1981→1986	OE108	RN3C	0.6	8904	PRO-5M
	RD LC (1A2)	1980→1988	OE008	RN7YCC	0.8	8332	PRO-5M
	RZ L, R, RR, W	1982→1988	OE108	RN3C	0.6	8904	
	SE		OE008	RN7YCC	0.8	8332	PRO-5M
	SR, SP		OE008	RN7YCC	0.8	8332	PRO-5M
	SR SE (3YB)	1980→	OE008	RN7YCC	0.8	8332	PRO-5M
	SRX N, U, UC		OE083	RA6HC	0.7	8809	PRO-5M
	TDR	1987→1989	OE091	RN2C	0.6	8904	PRO-5M
	TRD		OE091	RN2C	0.6	8904	PRO-5M
	Tricker XG	2005→	OE083	RA6HC	0.7	8809	
	TT		OE083	RA6HC	0.7	8809	PRO-5M
	TT R, RF	1990→	OE083	RA6HC	0.7	8809	PRO-5M
	TT S, T	1994→	OE092	RG4HC	0.7	8698	PRO-5M
	TT-R	2000→	OE092	RG4HC	0.7	8698	PRO-5M
	TY	1994→	OE079	N4C	0.6	8339	PRO-5M
	TY N (3BA)	1987→1990	OE108	RN3C	0.6	8904	PRO-5M
	TY R (38V)	1985→	OE098	RN4C	0.6	8339	PRO-5M
	TY Z	1984→1994	OE098	RN4C	0.6	8339	PRO-5M
	TZ (Racing)	→1983	OE125	N2G	0.6	8904	PRO-5M
	TZ (Racing)	1984→1992	OE125	N2G	0.6	8904	PRO-5M
	TZ (Racing)	1993→1994		QN84	0.6		PRO-5M
	TZ (Racing)	1994→		QN84	0.6		PRO-5M
	TZR (Racing)	1987→1989	OE091	RN2C	0.6	8904	PRO-5U
	TZR (Racing)	1991→		QN84	0.6		PRO-5U
	WR Z, ZE, ZF	1993→1995		QN86	0.6		PRO-5U
	WR-F	2001→		RG94C		8698	PRO-5U
	XS C, H, RH		OE010	N7YC	0.8	8332	PRO-5M
	XS SE, SH		OE010	N7YC	0.8	8332	SRO-5U
	XT	1985→1986	OE083	RA6HC	0.7	8809	PRO-5M
	XT H, J, K, KC	1987→	OE083	RA6HC	0.7	8809	PRO-5M
	XT L, LC, T, TL, TT (3Y3)	1982→1988	OE008	RN7YCC	0.8	8332	
	XT TN (3Y3)	1982→1989	OE083	RA6HC	0.7	8809	PRO-5M
	XV F Virago (3LS,W)	1994→		P-RZ9HC	0.7		
	XV S Virago	1994→		P-RZ9HC	0.7		
	XV W, WC Virago	1989→		P-RZ9HC	0.6		
	XVS Dragstar (Air cooled)	2000→		P-RZ9HC	0.7		
	YZ (Liquid cooled)	2001→	OE092	RG4HC	0.7	8698	PRO-5M
	YZ (3JE, 3KK)	1988→1991	OE108	RN3C	0.6	8904	PRO-5M
	YZ (4DA, 4EW)	1990→	OE108	RN3C	0.6	8904	PRO-5M

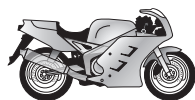

YAMAHA

**21****POWER
SPORT****...YAMAHA**

Capacity	Model	Year	OE Part	Part Code	Gap (mm)	Part Code	Part Code
...250cc	YZ (56A, 1LU)	1984 → 1988	OE108	RN3C	0.6	8904	PRO-5M
	YZ		OE108	RN3C	0.6	8904	PRO-5M
	YZ (5X5, 24Y)	1982 → 1985		QN86	0.6		PRO-5M
	YZ F (3SP)	1988 → 1991	OE108	RN3C	0.6	8904	PRO-5M
	YZ LC (2HH)	1984 → 1988	OE108	RN3C	0.6	8904	PRO-5M
350cc	BW		OE083	RA6HC	0.7	8809	
	RD H 12.7mm/1/2in.	1980 → 1984		L78C	0.6	8883	
	RD H 19mm/3/4in. (4L0)	1983 → 1986	OE108	RN3C	0.6	8904	
	RD LC (1WW)	1985 → 1990	OE091	RN2C	0.6	8904	
	RD LC (1WX)	1987 →	OE091	RN2C	0.6	8904	
	RD LC, LCF (31K)	1981 → 1988	OE108	RN3C	0.6	8904	
	RZ R, RR, S, ST		OE091	RN2C	0.6	8904	
	TT E, F	1993 →	OE083	RA6HC	0.7	8809	
	TT T (1TJ)	1986 → 1989	OE083	RA6HC	0.7	8809	
	TY N		OE004	RN9YCC	0.8	8415	
	TZ B, H (Racing)			QN84	0.6		PRO-5M
	XS		OE083	RA6HC	0.6	8809	
	XT (3YT)	1991 →	OE083	RA6HC	0.7	8809	
	XT (55V)	1993 →	OE083	RA6HC	0.7	8809	
	XT E, F (55V)	1985 → 1990	OE083	RA6HC	0.7	8809	
	YFP U Terrapro		OE083	RA6HC	0.7	8809	
YZ U, W		OE108	RN3C	0.6	8904		
360cc	BW T		OE083	RA6HC	0.7	8809	
	DT	1973 → 1975	OE040	N2C	0.8	8904	PRO-5M
	MX		OE108	RN3C	0.6	8904	PRO-5M
	XS	1977 → 1978	OE001	N9YC	0.7	8415	
	YZ		OE108	RN3C	0.6	8904	PRO-5M
400cc	DT E		OE091	RN2C	0.6	8904	PRO-5M
	DT H		OE108	RN3C	0.6	8904	PRO-5M
	DT MX, E, H (1R6)	1977 → 1981	OE108	RN3C	0.6	8904	PRO-5M
	FZ R		OE083	RA6HC	0.7	8809	SRO-5U
	FZR			RG94C	0.7	8698	
	FZR W, WC (4DX)	1987 →		RG94C	0.7	8698	
	IT		OE108	RN3C	0.6	8904	PRO-5M
	IT E		OE108	RN3C	0.6	8904	PRO-5M
	KJ J, RJ, K, RK, L		OE073	RA4HC	0.6		
	MX		OE108	RN3C	0.6	8904	PRO-5M
	RD (1A3)		OE108	RN3C	0.6	8904	PRO-5M
	RD E		OE108	RN3C	0.6	8904	PRO-5M
	SR		OE108	RN3C	0.6	8904	PRO-5M
	SRX		OE073	RA4HC	0.6		
	TT C		OE108	RN3C	0.6	8904	PRO-5M
	TT E		OE108	RN3C	0.6	8904	PRO-5M
	WR			RG94C	0.6	8698	
	XJ		OE083	RA6HC	0.7	8809	
	XS (4G5)	1980 → 1988	OE008	RN7YCC	0.8	8332	
	XS (12E)	1982 → 1989	OE083	RA6HC	0.7	8809	
	XS (12E)	1982 → 1989	OE083	RA6HC	0.7	8809	
	XS		OE083	RA6HC	0.6	8809	
	XS SP (2A2)	1980 → 1988	OE008	RN7YCC	0.8	8332	
XT	→ 1983	OE008	RN7YCC	0.8	8332		
XT	1984 →		P-RA7HC	0.7	8812		
XV SE, SP		OE008	RN7YCC	0.8	8332		
XZ		OE073	RA4HC	0.6			

**YAMAHA**

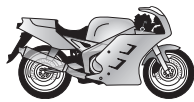
**21****POWER SPORT****...YAMAHA**

...400cc	YP Majesty	2005 →		RG96C	0.6	8698	
	YZ C, E		OE108	RN3C	0.6	8904	PRO-5M
	YZ F	1998 →		RG94C	0.6	8698	PRO-5M
425cc	IT		OE108	RN3C	0.6	8904	PRO-5U
426cc	WR F	2001 →		RG94C	0.8	8698	
	YZ F	2001 →		RG94C	0.8	8698	
450cc	WR F	2003 →		RG94C	0.8	8698	
	YZ F	2003 →		RG94C	0.8	8698	
465cc	IT H		OE108	RN3C	0.6	8904	PRO-5U
	IT J (4V6)	1981 →	OE108	RN3C	0.6	8904	PRO-5U
	YZ		OE108	RN3C	0.6	8904	PRO-5U
	YZ H		OE108	RN3C	0.6	8904	PRO-5U
490cc	IT L (29W)	1984 →1988	OE091	RN2C	0.6	8904	PRO-5M
	YZ N, J, KL			QN84	0.6		PRO-5M
	YZ T (2WH)			QN84	0.6		PRO-5M
500cc	FZR		OE092	RG4HC	0.7	8698	
	GX		OE083	RA6HC	0.7	8809	
	IT		OE010	N7YC	0.7	8332	PRO-5M
	MX		OE108	RN3C	0.6	8904	
	RD (47X)	1983 →1988		QL78C	0.6	8883	PRO-5M
	RD LC (1GE)	1984 →1987		QL78C	0.6	8883	PRO-5M
	SR (2J4)	1980 →1986	OE008	RN7YCC	0.8	8332	PRO-5M
	SR (3EB)	1991 →	OE008	RN7YCC	0.8	8332	PRO-5M
	SR (48T/48U)	1984 →	OE008	RN7YCC	0.8	8332	PRO-5M
	TK		OE073	RA4HC	0.6		
	TT, C, E, H, J		OE008	RN7YCC	0.8	8332	
	TT C		OE008	RN7YCC	0.8	8332	
	TT E		OE008	RN7YCC	0.8	8332	
	TT H		OE008	RN7YCC	0.8	8332	
	TX		OE083	RA6HC	0.7	8809	
	TZ, H (Racing)			QN84	0.6		
	XJ (4V8)	1978 →1983	OE083	RA6HC	0.7	8809	
	XS (4V8)	1977 →1982	OE083	RA6HC	0.7	8809	
	XS E (1H2)	1978 →1985	OE073	RA4HC	0.6		
	XT (1V6)	1976 →1989	OE008	RN7YCC	0.8	8332	PRO-5M
	XT	1986 →	OE008	RN7YCC	0.8	8332	PRO-5M
	XT	1993 →	OE083	RA6HC	0.9	8809	PRO-5M
	XT		OE083	RA6HC	0.9	8809	PRO-5M
	XT		OE083	RA6HC	0.9	8809	PRO-5M
	XT E, H (4E5)	1980 →1988	OE008	RN7YCC	0.8	8332	PRO-5M
	XT T, Z	1976 →1989	OE008	RN7YCC	0.8	8332	PRO-5M
	XV K, L, N, SE (1U6)	1984 →	OE008	RN7YCC	0.8	8332	
	XV SE (26R)	1981 →1988	OE008	RN7YCC	0.8	8332	
	YP Tmax ABS	2005 →		RG96C	0.6	8698	
535cc	XV Virago (2YL)	1988 →	OE008	RN7YCC	0.8	8332	
	XV Virago (3BR)	1988 →1993	OE008	RN7YCC	0.8	8332	
	XV Virago (3BR)	1993 →	OE008	RN7YCC	0.8	8332	
	XV Virago DX (Air cooled)	1995 →	OE018	RN7YC	0.7	8332	
550cc	XJ H, J, K, L, RH, RJ (4V8)	1980 →1988	OE083	RA6HC	0.7	8809	
	XT J, K (5Y3)	1980 →1988		P-RA7HC	0.7	8812	
	XZ RJ, RK		OE083	RA6HC	0.7	8809	
	XZ S (11V)	1983 →1984	OE083	RA6HC	0.6	8809	

**YAMAHA**

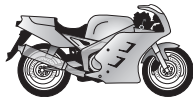
**21****...YAMAHA****600cc**

Diversión			RG94C	0.7	8698	
DT			P-RA7HC	0.7	8812	
FJ N, NC		OE083	RA6HC	0.7	8809	
FJ W		OE083	RA6HC	0.7	8809	
FZ ,U		OE083	RA6HC	0.7	8809	
FZ 6 Fazer / -S2	2004 →	OE092	RG4HC	0.7	8698	
FZ S		OE083	RA6HC	0.7	8809	
FZ TC, U, UC		OE083	RA6HC	0.7	8809	
FZR (4MH)	1994 →	OE092	RG4HC	0.7	8698	
FZR		OE092	RG4HC	0.7	8698	
FZR F, R, RF, RFC (3RH)	1989 →1993	OE092	RG4HC	0.7	8698	
FZR R (3HE)	1989 →1993	OE092	RG4HC	0.7	8698	
FZR R (3RG)	1989 →1993	OE092	RG4HC	0.7	8698	
FZR S Fazer	1994 →	OE092	RG4HC	0.7	8698	
FZR W, WC (4JH)	1994 →	OE092	RG4HC	0.7	8698	
FZS Fazer	2003 →2004	OE092	RG4HC	0.7	8698	
FZS Fazer	1998 →2002		RG94C	0.8	8698	
SRK (1XL)	1986 →1991	OE073	RA4HC	0.9		
SRX (1XN / 1XM)	1986 →1989		P-RA7HC	0.9	8812	SRO-5U
TT (36A)	1983 →1985		P-RA7HC	0.7	8812	
TT	1985 →1989		P-RA7HC	0.9	8812	
TT E, S	1986 →		P-RA7HC	0.9	8812	
TT NL	1985 →1986		P-RA7HC	0.9	8812	
TT S (4LW)	1993 →	OE083	RA6HC	0.9	8809	
TT S		OE083	RA6HC	0.9	8809	
TTR E		OE083	RA6HC	0.8	8809	
TTR R	1996 →	OE083	RA6HC	0.8	8809	
TTR R	1998 →	OE083	RA6HC	0.8	8809	
XJ (4BR / 4BRA / 4BRB)	1991 →		RG94C	0.7	8698	
XJ (4EB / 4LX)	1995 →		RG94C	0.7	8698	
XJ (Air cooled) (4PR)	1992 →		G57C	0.6	8654	
XJ N (4KA / 4MB)	1995 →	OE092	RG4HC	0.7	8698	
XJ N (51J / 3KM / 3KN)	1984 →1990	OE083	RA6HC	0.7	8809	
XJ N (3KN)	1990 →	OE073	RA4HC	0.6		
XJ N (51J)	1989 →	OE073	RA4HC	0.6		
XJ S Diversión (4LX/4EB)	1994 →	OE092	RG4HC	0.7	8698	
XJ S Diversión (4BR)	1994 →		RG96C	0.6	8698	
XJ S Diversión (3KM)	1991 →	OE073	RA4HC	0.9		
XT E	1994 →	OE083	RA6HC	0.9	8809	
XT E, EF, EFC	1994 →		RAX92YC	0.9	8809	
XT E, EF, EFC Heavy Load (3TB / 3UW)	1990 →	OE083	RA6HC	0.9	8809	
XT E, K (Air cooled)	2000 →	OE083	RA6HC	0.9	8809	
XT L			P-RA7HC	0.7	8812	
XT N, NC, T, TC		OE083	RA6HC	0.9	8809	
XT S	1986 →	OE083	RA6HC	0.9	8809	
XT U, W		OE083	RA6HC	0.9	8809	
XT UC, W		OE083	RA6HC	0.9	8809	
XT Z (2KF)	1986 →	OE083	RA6HC	0.9	8809	
XT Z	1985 →		P-RA7HC	0.6	8812	
XT Z Tenere (1VJ / 3AJ)	1986 →		P-RA7HC	0.9	8812	
XT ZK, Z Tenere (3UW)	→1985		P-RA7HC	0.7	8812	
XV SC, SZ Virago		OE083	RA6HC	0.9	8809	
YFM	1998 →	OE083	RA6HC	0.9	8809	
YX S, TC, U, UC, W, WC		OE083	RA6HC	0.7	8809	

**YAMAHA**

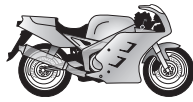
**21****POWER
SPORT****...YAMAHA**

Capacity	Model	Year	OE Part	Part	Gap (mm)	Part	Part
...600cc	YZF R Thundercat	1996 →	OE092	RG4HC	0.7	8698	
	YZF R6	1999 →	OE092	RG4HC	0.7	8698	
650cc	Drag Star (4VR/4XR)	1997 →		P-RA7HC	0.9	8812	
	TS		OE108	RN3C	0.6	8904	
	TX		OE108	RN3C	0.6	8904	
	XJ ,H, LH, SH	1980 →	OE010	N7YC	0.7	8332	
	XJ Turbo	1982 →	OE116	RN6YC	0.7	8902	
	XS (447)	1976 →1983	OE087	N6YC	0.7	8902	
	XS , E, H, II, S, SE, SH		OE010	N7YC	0.7	8332	
	XT	1980 →1988	OE008	RN7YCC	0.8	8332	
	XVS Drag Star, Classic	1996 →		P-RA7HC	0.8	8812	
660cc	MT 03	2006 →		RG96C	0.6	8698	
	SZR	1996 →		RAX92YC	0.8	8809	
	TT S, E (4LW)	1996 →	OE073	RA4HC	0.9		
	XT R	2004 →		RG96C	0.6	8698	
	XT X	2004 →		RG96C	0.6	8698	
	XTZ Tenere (3YF)	1991 →1993		RAX92YC	0.9	8809	
	XTZ Tenere (3YF)	1997 →	OE083	RA6HC	0.9	8809	
	XTZ Tenere (4MD)	1994 →	OE083	RA6HC	0.7	8809	
	700cc	FZX SC, T, TC (1FM)		OE083	RA6HC	0.9	8809
XJ XS, XSC (41Y)		1982 →1988	OE083	RA6HC	0.7	8809	
XV Virago			OE010	N7YC	0.7	8332	
750cc	FZ (1TB)	1986 →1989	OE083	RA6HC	0.7	8809	
	FZ (3DY)	1987 →	OE083	RA6HC	0.9	8809	
	FZ Genesis (1FN)	1984 →1988	OE083	RA6HC	0.7	8809	SRO-5U
	FZ N, SC (3KT)	1990 →	OE083	RA6HC	0.7	8809	SRO-5U
	FZ T, U (2KK)	1984 →1992	OE083	RA6HC	0.7	8809	
	FZ UC		OE083	RA6HC	0.9	8809	
	FZR (3WM)	1989 →	OE083	RA6HC	0.9	8809	
	FZR Genesis (2JE)	1987 →1989	OE083	RA6HC	0.7	8809	
	FZR R (3JE)	1986 →1993	OE083	RA6HC	0.7	8809	
	FZR R (3PJ)	1988 →1992	OE083	RA6HC	0.7	8809	
	FZR RU (3CU)	1988 →1992	OE083	RA6HC	0.7	8809	
	FZX Fazer (2JE)	1995 →	OE083	RA6HC	0.7	8809	
	FZX T (1UG)	1986 →1988	OE083	RA6HC	0.7	8809	
	TZ		OE125	N2G	0.5	8904	PRO-5M
	TZ D		OE125	N2G	0.6	8904	PRO-5M
	XJ Laguna Seca (11M)	1982 →1989	OE079	N4C	0.7	8339	PRO-5M
	XJ RH (41Y)	1983 →1988	OE079	N4C	0.7	8339	PRO-5M
	XJ XS		OE083	RA6HC	0.7	8809	
	XS , C, CT, D, E, T, SE	1977 →	OE079	N4C	0.7	8339	
	XTS SE		OE079	N4C	0.7	8339	
	XTZ Super Tenere	1989 →	OE083	RA6HC	0.9	8809	
	XV Virago, SE	1984 →	OE018	RN7YC	0.8	8332	
	XV Virago, SE	1981 →1983	OE079	N4C	0.7	8339	
	YZF R, RE, RFC	1993 →	OE092	RG4HC	0.9	8698	
	YZF R7	1999 →		G57R	0.6		
	YZF SP, SPF	1999 →	OE092	RG4HC	0.8	8698	

**YAMAHA**

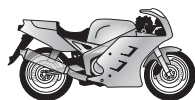
**21****POWER
SPORT****...YAMAHA**

Capacity	Model	Year	Part No.	Thread	Gap (mm)	Part No.	Notes
850cc	KS LH, H (4.00E+02)	1981→1988	OE008	RN7YCC	0.8	8332	
	TDM	1996→1996		RAX92YC	0.9	8809	
	TDM	1991→1995	OE083	RA6HC	0.9	8809	
	TDM	1997→	OE083	RA6HC	0.9	8809	
	TDM F	1991→1995	OE083	RA6HC	0.9	8809	
	TRX	1996→1996		RAX92YC	0.9	8809	
	TRX	1995→1995	OE083	RA6HC	0.9	8809	
	TRX	1997→	OE083	RA6HC	0.9	8809	
	XS, H, LH, SH		OE010	N7YC	0.7	8332	
	900cc	TDM	2002→	OE083	RA6HC	0.9	8809
XJ		1983→	OE116	RN6YC	0.6	8902	
XJ S Diversion		1995→	OE083	RA6HC	0.9	8809	
920cc	XV Virago		OE087	N6YC	0.7	8902	
1000cc	BT Bulldog	2002→	OE018	RN7YC	0.7	8332	
	FZ1	2006→	OE092	RG4HC	0.7	8698	
	FZ1 Fazer	2006→	OE092	RG4HC	0.7	8698	
	FZR EXUP I (3LE)	1994→	OE083	RA6HC	0.9	8809	
	FZR F (2LA)	1986→	OE083	RA6HC	0.7	8809	
	FZR FC	1991→	OE083	RA6HC	0.7	8809	
	FZR Genesis	1994→	OE083	RA6HC	0.7	8809	
	FZR U		OE083	RA6HC	0.7	8809	
	FZS Fazer (Liquid cooled)	2000→	OE092	RG4HC	0.7	8698	
	GTS A, AF, AFC (4B/4FE)	1992→	OE083	RA6HC	0.9	8809	
	TR1		OE018	RN7YC	0.7	8332	
	W W, WC		OE083	RA6HC	0.9	8809	
	XV Virago, F, FC, SE, SH		OE018	RN7YC	0.7	8332	
	YZF R Thunder Ace	1996→2002	OE083	RA6HC	0.7	8809	
	YZF R1	2007→	OE092	RG4HC	0.7	8698	
	YZF R1 (5PW1, 5PW2)	2002→2003	OE122	RG4PHP	0.9	8698	
	YZF R1 (RN012, RN04)	1998→2001	OE092	RG4HC	0.7	8698	
	YZF R1, SP	2004→2006	OE092	RG4HC	0.7	8698	
	1100cc	FJ (47E)	1984→1985	OE083	RA6HC	0.9	8809
FJ N, NC		→1984	OE083	RA6HC	0.7	8809	
XJ K, L			OE001	N9YC	0.7	8415	
XS, E, H, LH, RH, S, SH			OE001	N9YC	0.7	8415	
XV Virago, SC		1995→	OE018	RN7YC	0.8	8332	
XVS1100 Dragstar		1999→	OE018	RN7YC	1.0	8332	
1200cc		FJ, AE, AEC, E, F	1986→	OE083	RA6HC	0.9	8809
	V Max (Liquid cooled)		OE083	RA6HC	0.9	8809	
	V Max ZEN I (Liquid cooled) (3LR)	1995→	OE083	RA6HC	0.9	8809	
	VMX Black Max (Liquid cooled)		OE083	RA6HC	0.9	8809	
	VMX F, FC (Liquid cooled)	1996→	OE083	RA6HC	0.9	8809	
	VMX S, T, U (Liquid cooled) (47G)		OE083	RA6HC	0.9	8809	
	XJR (4PU)	1995→	OE083	RA6HC	0.9	8809	
	XV TD		OE083	RA6HC	0.9	8809	
	XVZ 12 T (47G)	1984→1987	OE083	RA6HC	0.9	8809	
	XVZ 12 TD		OE083	RA6HC	0.9	8809	
1300cc	FJR (Liquid cooled)	2000→		RG94C	0.7	8698	
	XJR	1999→	OE083	RA6HC	0.9	8809	
	XVZ 13 A	1997→	OE083	RA6HC	0.9	8809	
	XVZ 13 DE	1993→	OE083	RA6HC	0.9	8809	
	XVZ Royal Star (4NL/4NK)	1996→		P-RA7HC	0.9	8812	
	XVZ Royal Star Venture (Liquid cooled)	1999→	OE083	RA6HC	0.9	8809	

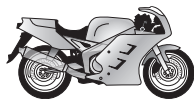
**21****POWER SPORT****...YAMAHA**

1600cc	XV Roadstar (Air cooled)	1999 →	P-RA7HC	0.7	8812
	XV Wildstar (Air cooled)	1999 →	P-RA7HC	0.7	8812
1670cc	MT-01	2005 →	P-RA7HC	0.7	8812
	XU Road Star Warrior	2003 →	P-RA7HC	0.7	8812
1900cc	XV	2006 →	OE083 RA6HC	0.9	8809

ZANELLA

50cc	All models		OE037 L86C	0.5	
100cc	All models		OE086 RL82C	0.5	8814
125cc	All models		OE086 RL82C	0.5	8814

ZID

175cc	Sova 175	1993 →	OE007 L87YC	0.6	
	Woshod 124.000-01-900 7,7kW		OE007 L87YC	0.7	
	Woshod 128.000-01-900 10,3kW		OE007 L87YC	0.7	
	Woshod 144.000-01-900 9,9kW		OE007 L87YC	0.7	
197cc	Fermer 3DK5.904 9,6kW		OE007 L87YC	0.7	
	Zid-200 3DK5.104 11,1kW		OE007 L87YC	0.7	
200cc	Sova 11kW		OE007 L87YC	0.7	

ZONGSHEN

125cc	CG125		RA8HC		8812
	ZS125GY-A		OE083 RA6HC		8809
150cc	CG150		RA8HC		8812
200cc	ZS200GY-A		OE083 RA6HC		8809

ZUNDAPP

50cc	Auto Mofa		OE037 L86C	0.8	
	Auto Moped		OE037 L86C	0.8	
	C Sport		L82C	0.6	8814
	C Super		L82C	0.6	8814
	Combinette		OE037 L86C	0.8	
	Combinette Super		OE037 L86C	0.8	
	CS		OE001 N9YC	0.8	8415
	CS 25		OE001 N9YC	0.8	8415
	CS Mokick		OE010 N7YC	0.8	8332
	CX 25 Mofa		OE001 N9YC	0.8	8415
	GTS	1981 →	OE010 N7YC	0.8	8332
	GTS	1980 →	OE001 N9YC	0.8	8415
	GTS Super	→1981	L82C	0.6	8814
	Hai		OE010 N7YC	0.8	8332
	Hai 25		OE001 N9YC	0.8	8415
	High Riser 44		OE059 L92YC	0.8	
	KS		L78C	0.6	8883
	KS		L78C	0.6	8883
	KS Cross		L78C	0.6	8883
	KS Sport (Air cooled)		L78C	0.6	8883
	KS SS		OE040 N2C	0.6	8904
	KS Super		L78C	0.6	8883
	KS Super Sport		L78C	0.6	8883
	KS TT, WK		OE040 N2C	0.6	8904
	M		OE037 L86C	0.8	
	Mofa 25		OE001 N9YC	0.8	8415
	Mofa X25		OE037 L86C	0.8	
	Mokick 6.25		OE010 N7YC	0.8	8332
	Mokick 6.25 (Liquid cooled)		OE040 N2C	0.6	8904
	Mokick CS50		OE010 N7YC	0.8	8332

**ZUNDAPP**

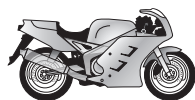
**21****POWER
SPORT****...ZUNDAPP**

Capacity	Model	Year	OE Part	Part No.	Gap (mm)	Part No.
...50cc	Mokick GTS50		OE010	N7YC	0.8	8332
	Mokick ZE40 (Air cooled)			L78C	0.6	8883
	R			L82C	0.6	8814
	R	1981 →	OE037	L86C	0.8	
	RS Super			L78C	0.6	8883
	RS Super			L78C	0.6	8883
	RT 159, Jet, Super			L78C	0.5	8883
	TT		OE040	N2C	0.6	8904
	ZA 25	1981 →	OE037	L86C	0.8	
	ZA 40	1981 →	OE037	L86C	0.8	
	ZD 40,80,50TS	1981 →	OE037	L86C	0.8	
	ZL 25		OE001	N9YC	0.8	8415
	ZR 10,20,30		OE001	N9YC	0.8	8415
ZS 25		OE001	N9YC	0.8	8415	
ZX 25		OE001	N9YC	0.8	8415	
75cc	KS			L78C	0.6	8883
80cc	KS		OE040	N2C	0.6	8904
	KS Super		OE040	N2C	0.6	8904
	KS Touring type 314		OE040	N2C	0.6	8904
	SX		OE040	N2C	0.6	8904
100cc	ISDT			L78C	0.6	8883
	KS			L78C	0.6	8883
	Scrambler			L78C	0.6	8883
125cc	GS			L77JC4	1.0	8883
	ISDT			L78C	0.5	8883
	KS			L78C	0.6	8883
	MC			L77JC4	1.0	8883
	Moto-Cross			L78C	0.5	8883
	Sport			L78C	0.6	8883
175cc	KS		OE068	N3C	0.6	8904
350cc	KS		OE068	N3C	0.6	8904
600cc	KS	1938 →	OE007	L87YC	0.6	
601cc	KS		OE007	L87YC	0.6	

ZUNDAPP

**21****POWER
SPORT****APRILIA**

Capacity	Model	Year	Part No.	Part No.	mm	Part No.	Part No.
25cc	Amico	1996→	OE086	RL82C	0.6	8814	PRO-5M
50cc	Amico		OE086	RL82C	0.6	8814	
	Gulliver (Air cooled)	1996→	OE086	RL82C	0.6	8814	PRO-5M
	Gulliver (Liquid cooled)	1996→		RL78C	0.6	8883	PRO-5M
	Habana City (Air cooled)	1999→		L78YC		8883	PRO-5M
	Habana Custom City (Air cooled)	1998→	OE064	RL82YC		8814	PRO-5M
	Mojito Custom	1999→	OE064	RL82YC		8814	
	MX		OE091	RN2C	0.6	8904	
	Rally (Air cooled)	1996→	OE064	RL82YC	0.6	8814	PRO-5M
	Rally (Liquid cooled)	1996→		RL78C	0.5	8883	PRO-5M
	Scarabeo	2001→	OE064	RL82YC	0.6	8814	PRO-5M
	Sonic City (Air cooled)	1997→		RL78C		8883	PRO-5M
	Sonic City (Liquid cooled)	1997→		RL78C		8883	PRO-5M
	Sonic GP City (Air cooled)	1997→		RL78C	0.5	8883	PRO-5M
	Sonic GP City (Liquid cooled)	1997→		RL78C	0.5	8883	PRO-5M
	SR	2001→2002	OE086	RL82C	0.6	8814	
	SR	2001→2004		RG6YCA	0.6		
	SR Di Tech Injection (Air cooled)	1994→	OE086	RL82C	0.6	8814	PRO-5M
	SR Stealth / LC / Racing (Liquid cooled)	1996→	OE086	RL82C	0.6	8814	PRO-5M
	SR WWW (Carb)	2004→		RN1C	0.6	8904	
51cc	Area 51	1998→		RL78C	0.5	8883	PRO-5M
100cc	Scarabeo 2T	2000→		RL78C	0.7	8883	
	Scarabeo 4T	2000→		RG96C	0.7	8698	
125cc	Atlantic 125	2003→		RG6YC	0.6		
	Habana City (Air cooled)	2000→		RG96C		8698	
	Habana Custom City (Air cooled)	2000→		RG96C		8698	
	Leonardo	1996→2004	OE092	RG4HC	0.6	8698	SRO-5U
	Mojito	2005→		RG96C	0.7	8698	
	Scarabeo	1999→		RG96C		8698	
	Scarabeo	2001→		RG6YC			
	Sport City	2004→		RG6YC			
	SR Sport (Air cooled)	2000→	OE091	RN2C	0.6	8904	
150cc	Leonardo	1997→2004	OE092	RG4HC	0.6	8698	
	Mojito	2003→		RG96C	0.7	8698	
	Scarabeo	1998→		RG94C	0.6	8698	
	SR	1999→	OE091	RN2C	0.6	8904	
200cc	Atlantic	2004→	OE092	RG4HC	0.6	8698	
	Scarabeo	2000→	OE092	RG4HC	0.6	8698	
	Sportcity	2006→		RG6YC	0.6		
250cc	Atlantic	2004→	OE092	RG4HC	0.6	8698	
	Leonardo	1999→2003	OE083	RA6HC	0.6	8809	
	Scarabeo	2004→	OE092	RG4HC	0.6	8698	
	Sport City	2006→	OE122	RG4PHP	0.6	8698	
300cc	Leonardo	1998→2000	OE083	RA6HC	0.6	8809	
500cc	Atlantic 500	2005→2006		RG6YC	0.6		
	Atlantic 500 Sprint	2001→2004		RG6YC	0.6		
	Scarabeo 500	2002→		RG6YC	0.6		

**APRILIA**

**21****POWER SPORT****ATALA**

50cc	Byte			L82C		8814
	Byte 25		OE064	RL82YC		8814
	Byte 50		OE064	RL82YC		8814
	Carosello	1997→		L82C		8814
	Hacker AT12	1996→	OE064	RL82YC	0.5	8814
	Hacker AT14	1996→	OE064	RL82YC	0.5	8814
	Hacker Racing	1996→	OE064	RL82YC	0.5	8814
	Master LF		OE037	L86C		
	Racing	1996→	OE064	RL82YC	0.5	8814
	Skeggia	1998→	OE064	RL82YC		8814

BAJAJ

50cc	Spirit		OE037	L86C	0.6	
	Sunny		OE037	L86C	0.6	
95cc	KRISTAL DTS-I Scooter Primary+Secondary Plug (Twinspark)	2008→	OE092	RG4HC		8698
111cc	Chetak Caliber	1998→		P-RZ9HC	0.7	
125cc	Chetak Standard , Classic		OE007	L87YC	0.6	
150cc	Chetak Standard , Classic Electronic			RL95YC	0.6	
	Chetak Standard , Classic		OE059	L92YC	0.6	
	Chetak, Viking	1980→1985		RL86C	0.6	

BENELLI

50cc	491		OE108	RN3C	0.6	8904
	491 GP-RR	1999→	OE086	RL82C	0.7	8814
	491 GP-SP	1999→	OE086	RL82C	0.7	8814
	491 GT aircooler	1997→	OE086	RL82C	0.6	8814
	491 Racing watercooler	1997→	OE086	RL82C	0.6	8814
	491 Rage ST	2000→		RL78C	0.7	8883
	491 SBK	2000→		RL78C	0.7	8883
	491 Sport watercooler	1997→	OE086	RL82C	0.6	8814
	491 ST GP	2000→		RL78C	0.7	8883
	491 Superbike watercooler	1999→	OE086	RL82C	0.6	8814
	K2	1998→	OE086	RL82C	0.5	8814
	Laser		OE037	L86C	0.5	
	Moped		OE098	RN4C	0.5	8339
	Naked	1998→		RL78C		8883
	Pepe	1999→		RL78C		8883
	Pepe Kat	1999→		RL78C		8883
	S		OE037	L86C	0.5	
	Scooty DL,DLX			L82C	0.5	8814
100cc	K2	1999→		RL78C	0.5	8883
125cc	Adiva			RG94C	0.5	8698
	Velvet Eco	1999→		RG94C	0.7	8698
150cc	Adiva			RG94C	0.5	8698
	Velvet Eco	1999→		RG94C	0.7	8698
250cc	Velvet Eco	2000→	OE083	RA6HC	0.7	8809
400cc	Dusk	2005→	OE092	RG4HC	0.6	8698
	Amico		OE098	RN4C	0.8	8339

BETA

50cc	Ark (Air/Liquid cooled)	1996→		RL78C	0.5	8883
	Chrono 50 / 502	1995→	OE086	RL82C	0.5	8814
	Eikon (Liquid cooled)	2000→		RL78C	0.5	8883
	Quadra (Air cooled)		OE086	RL82C	0.5	8814
	Tempo		OE086	RL82C	0.5	8814

**21****POWER
SPORT****...BETA**

125cc	Alp (Air cooled) (Suzuki)	2000 →	OE083	RA6HC	0.9	8809
	Alp 4T		OE010	N7YC	0.8	8332
	Eikon (Liquid cooled)	2000 →		P-RA7HC	0.7	8812
150cc	Eikon (Liquid cooled)	2000 →		P-RA7HC	0.7	8812
250cc	REV-3		OE010	N7YC	0.6	8332

BMW

125cc	C1 (Liquid cooled)	2000 → 2002		RG6YC		
200cc	C1	2001 → 2002		RG6YC		

BS VILLA

50cc	Giorno			RL78C	0.6	8883
	GP Dio		OE064	RL82YC	0.6	8814
	SP Dio	1990 →	OE064	RL82YC	0.6	8814
	Z5	1993 →		RL78C	0.6	8883
	ZX	1993 →		RL78C	0.6	8883

BUFFALO

50cc	CY 25	1997 →	OE086	RL82C	0.6	8814
	CY 50	1997 →	OE086	RL82C	0.6	8814
	CY 50 aircooled	1996 →	OE086	RL82C	0.6	8814
	MK 50	1996 →	OE007	L87YC	0.6	
	MM 50	1997 →	OE086	RL82C	0.6	8814
	MY 50 aircooled	1996 →	OE086	RL82C	0.6	8814
	Silver watercooled	1996 →	OE108	RN3C	0.5	8904

CAGIVA

50cc	City	1994 → 1997	OE064	RL82YC	0.6	8814
	City	1998 →		RL78C	0.6	8883
	City , City LE	1993 →		L82C	0.6	8814
	Cucciolo			L78C	0.5	8883
	Mantis	1998 →	OE040	N2C	0.6	8904
	Passing		OE007	L87YC	0.6	
	Progress	1997 →		L78C	0.5	8883
	Progress Corsa		OE040	N2C	0.6	8904
	Scooter	1993 →		RL78C	0.6	8883
125cc	Cucciolo	1999 →		RG96C	0.5	8698
	Nuvola			RG96C	0.5	8698
	Passing	1994 →		RL87YC	0.6	

CAPRI

50cc	Roller 50		OE079	N4C	0.5	8339
	Roller 50S		OE068	N3C	0.5	8904
125cc	Roller 125			L78C	0.6	

CCF

50cc	Adly 50	1996 →	OE038	L82YC	0.6	8814
	Cat 50	1997 →	OE038	L82YC	0.6	8814
100cc	Adly 100	1996 →	OE038	L82YC	0.6	8814
125cc	Cat 125	1998 →		RZ96C	0.6	

CPI

50cc	Aragon 50	2006 →	OE098	RN4C	0.8	8339
	Aragon GP Sport	2006 →	OE098	RN4C	0.8	8339
	Bingo FL	2002 → 2002		RL78C	0.6	8883
	GTR 50	2003 →	OE098	RN4C	0.8	8339
	GTS 50	2003 →	OE098	RN4C	0.8	8339
	Hussar	2001 → 2001		RL78C	0.6	8883
	Hussar Euro 2	2003 →	OE098	RN4C	0.8	8339

**CPI**

**21****POWER SPORT**

...CPI						
...50cc	Hussar FL	2002 → 2002	RL78C	0.6	8883	
	Hussar SL	2002 → 2002	RL78C	0.6	8883	
	Oliver 50	2003 →	OE098 RN4C	0.8	8339	
	Oliver City	2006 →	OE098 RN4C	0.8	8339	
	Oliver Sport	2006 →	OE098 RN4C	0.8	8339	
	Popcorn	2000 → 2001	RL78C	0.6	8883	
	Popcorn Euro 2	2003 →	OE098 RN4C	0.8	8339	
	Popcorn FL	2002 → 2002	RL78C	0.6	8883	
	Popcorn SL	2002 → 2002	RL78C	0.6	8883	
	Tennessee	2001 →	RL78C	0.6	8883	
125cc	Aragon 125	2006 →	RZ96C	0.6		
	GTS 125	2003 →	OE098 RN4C	0.8	8339	
	X-Large 125	2003 →	OE098 RN4C	0.8	8339	
150cc	GTS 150	2003 →	OE098 RN4C	0.8	8339	
	X-Large 150	2003 →	OE098 RN4C	0.8	8339	
200cc	GTS 200	2003 →	OE098 RN4C	0.8	8339	
	X-Large 200	2003 →	OE098 RN4C	0.8	8339	
DAELIM						
50cc	Cordi 50	2004 →	OE064 RL82YC	0.6	8814	
	E-Five	2003 →	L78C	0.6		
	Message (Air cooled)	1998 →	RL78C		8883	
	S-Five	2002 →	L78C	0.6		
	Tapo	1999 →	RL78C		8883	
100cc	Altino A, S	1998 →	RGU94C		8698	
	Delfino		RL78C	0.6	8883	
110cc	Citi Ace 110	2003 →	Z9Y	0.7		
125cc	Advance	1997 →	RGU94C	0.9	8698	
	Classic	2000 →	RGU94C	0.9	8698	
	Daystar	2000 →	RGU94C		8698	
	Evolution	1997 →	RGU94C	0.9	8698	
	Evolution VS	2002 →	RGU94C	0.9	8698	
	Freewing / S2	2005 →	RGU94C	0.9	8698	
	NS 125	1998 →	RGU94C	0.9	8698	
	NS Fellow	1998 →	RGU94C		8698	
	NS Trans Eagle	1999 →	RGU94C		8698	
	Othello	1999 →	RGU94C		8698	
	SL History 125		RGU94C	0.9	8698	
	VC	1995 →	RGU94C		8698	
	VS Advance	1995 →	RGU94C		8698	
DERBI						
50cc	Atlantis	1999 →	RL78C		8883	
	Atlantis Liquid Cooled	1999 →	OE040 N2C		8904	
	Aventura	1995 → 1997	L78C	0.5	8883	
	Bullet	2003 →	OE091 RN2C		8904	
	Furax	1995 →	L78C	0.5	8883	
	GP R		OE091 RN2C	0.5	8904	
	GP R-50R		OE068 N3C		8904	
	Hunter	1996 →	OE038 L82YC	0.5	8814	
	Hunter	1996 →	L78C	0.5	8883	
	Hunter	1995 →	OE068 N3C	0.6	8904	
	Manhattan	1997 →	L78C	0.5	8883	
	Paddock	1996 →	L78C	0.5	8883	
	Paddock (Liquid cooled)	1998 →	OE040 N2C		8904	

**21****POWER
SPORT****...DERBI**

...50cc	Paddock (Liquid cooled)	1998 →	OE068	N3C		8904	
	Paddock [S]	1996 →	OE038	L82YC	0.5	8814	
	Predator [A][D]		OE068	N3C		8904	
	Predator [E]		OE040	N2C		8904	
	Racing Replica	2002 →	OE091	RN2C	0.5	8904	
	Rambla		OE091	RN2C	0.5	8904	
	Red Bullet	2003 →	OE091	RN2C	0.5	8904	
	Vamos	→1997		L78C	0.5	8883	
	Vamos China	→1997		L78C	0.5	8883	
	Vamos China	1998 →		QL78C	0.5	8883	
	Vamos L,N,R	1998 →		L78YC	0.5	8883	
	Variant	1992 →		QL78C	0.5	8883	
	Variant Box,Classic,Courier,SLE-X,Sport R,Start W-CH		OE086	RL82C	0.5	8814	
	Variant Start			QL78C	0.5	8883	
100cc	Atlantis		OE040	N2C	0.6	8904	
125cc	Boulevard		OE092	RG4HC	0.7	8698	
	Rambla		OE091	RN2C	0.6	8904	
150cc	Boulevard		OE092	RG4HC	0.7	8698	
DÜRRKOPP							
47cc	Moped		OE037	L86C	0.5		
171cc	Diana TS			L78C	0.5	8883	
194cc	Diana			L82C	0.5	8814	
EASY RIDER							
50cc	JL (Air cooled)	2000 →		RL87YC	0.6		
100cc	JLT (Air cooled)	2000 →		RL87YC	0.6		
ENDRESS							
50cc	Emr			L78C	0.6	8883	PRO-5M
	Emr AP			L78C	0.6	8883	PRO-5M
	Emr DJ			L78C	0.6	8883	PRO-5M
	Emr SK , TD			L78C	0.6	8883	PRO-5M
ERING							
50cc	Cat 50		OE037	L86C	0.6		
	Jet 50		OE037	L86C	0.6		
	Rapido		OE037	L86C	0.6		
	Silver Fox		OE037	L86C	0.6		
	Sprint 50			Z9Y	0.7		
	Thunderbike 50		OE037	L86C	0.6		
125cc	Cat 125			RZ96C	0.6		
	Shining 125			RZ96C	0.6		
	Thunderbike 125			RZ96C	0.6		
FAMEL							
50cc	Yuppie, XF		OE040	N2C	0.6	8904	
FANTIC							
50cc	Grinta			L78C	0.5	8883	
	Koala		OE108	RN3C	0.6	8904	
	Oasis 50.1		OE108	RN3C	0.6	8904	
	Pony			L78C	0.5	8883	
	Queenie			L78C	0.5	8883	
75cc	Koala		OE091	RN2C	0.5	8904	
	Oasis 2		OE091	RN2C	0.5	8904	
80cc	Caballero		OE091	RN2C	0.5	8904	
	Caballero GS Special		OE091	RN2C	0.5	8904	

**FANTIC**

**21****POWER
SPORT****GARELLI**

50cc	303 50		OE064	RL82YC	0.6	8814	
	Astro 50	2001 →		QL77JC4	0.6	8883	
	Astro 50			QL77JC4	0.6	8883	
	Big Wheel			L78C	0.5	8883	
	Flo 50		OE064	RL82YC	0.6	8814	
	FX 50			QL77JC4	0.6	8883	
	Grinta 50	1993 →	OE007	L87YC	0.6		
	Hussar 50			RL78C	0.6	8883	
	KRC 50			QL77JC4	0.6	8883	
	KRS 50			QL77JC4	0.6	8883	
	M 901 50			QL77JC4	0.6	8883	
	Mars 50			QL77JC4	0.6	8883	
	Match 50			RL78C	0.6	8883	
	PMX Rally 50		OE064	RL82YC	0.6	8814	
	PMX Sport 50		OE064	RL82YC	0.6	8814	
	Pony			L78C	0.5	8883	
	Queenie 50	1992 →	OE007	L87YC	0.6		
	Raider 50			QL77JC4	0.6	8883	
	Roadshow 50			QL77JC4	0.6	8883	
	RZ1 50			QL77JC4	0.6	8883	
	Shark 50			QL77JC4	0.6	8883	
	SR		OE007	L87YC	0.6		
	SR, Racing			L78C	0.5	8883	
	Starter 50			QL77JC4	0.6	8883	
106cc	PMX Sport			RL78C	0.6	8883	
110cc	PMX Sport 110		OE064	RL82YC	0.6	8814	
125cc	303 R 125			RZ96C	0.5		
	Blast 125			RZ96C	0.5		
	GTA		OE091	RN2C	0.5	8904	
	Hussar 125	2001 →		RZ96C	0.6		
	Hussar 125			RZ96C	0.6		
	Joker 125	2003 →		RZ96C	0.7		
	Tiger 125XLE		OE091	RN2C	0.5	8904	
	Tiger 125XR		OE091	RN2C	0.5	8904	
	Tiger 125XRD		OE091	RN2C	0.5	8904	
	T-Rex 125			RZ96C	0.6		
	T-Rex 150	2001 →		RZ96C	0.5		
150cc	Freeland 150			RZ96C	0.7		
	Joker 150			RZ96C	0.7		
	T-Rex 150			RZ96C	0.5		
	T-Rex 150 2001	2001 →		RZ96C	0.6		
	GS-1			RL78C	0.6	8883	
	XM-1			RL78C	0.6	8883	
GILERA							
50cc	DNA	2000 →	OE091	RN2C		8904	
	Dyna	1999 →		N1C	0.5	8904	PRO-5M
	Eaglet		OE091	RN2C	0.5	8904	PRO-5M
	Easy Moving	1995 →	OE040	N2C		8904	
	GSM		OE091	RN2C	0.5	8904	PRO-5M
	ICE	2000 →	OE040	N2C		8904	
	Pure Jet 50	2004 →		RG6YC	0.6		
	Runner DD, SP	1997 →		N1C	0.5	8904	PRO-5M
	Stalker DD, DT	1997 →	OE040	N2C	0.5	8904	PRO-5M
	Storm		OE091	RN2C	0.5	8904	

**21****POWER
SPORT****...GILERA**

...50cc	Typhoon , Street, Benetton		OE091	RN2C	0.5	8904	PRO-5M
	Typhoon X Cat		OE091	RN2C	0.5	8904	PRO-5M
125cc	Cougar	2000 →	OE083	RA6HC	0.8	8809	
	DNA	2001 →		RG94C	0.7	8698	
	Runner FX 125	1997 →	OE040	N2C	0.6	8904	PRO-5M
	Runner VX, RST	2001 →		RG94C	0.7	8698	
	Typhoon	1995 →	OE040	N2C	0.5	8904	PRO-5M
	Typhoon X Cat		OE091	RN2C	0.6	8904	PRO-5M
150cc	Runner FXR, SP		OE091	RN2C	0.5	8904	
176cc	Runner FXR		OE091	RN2C	0.5	8904	
180cc	DNA	2001 →		RG94C	0.7	8698	
	Runner VX	2001 →		RG94C	0.7	8698	
500cc	Nexus 500	2003 →		RG6YC	0.6		PRO-5M

HARLEY DAVIDSON

Topper, AH

RH8C

1.1

HEINKEL

150cc	Tourist 150	1962 →		D14			
175cc	Tourist 175	1960 →		L82C	0.5	8814	
	Perle Moped			L78C	0.6	8883	

HERKULES

50cc	BT 50	2005 →		Z9Y	0.7		PRO-5M
	TB 50 Race	2005 →	OE064	RL82YC	0.6	8814	PRO-5M

HMZ

50cc	Cab SB50	1996 →	OE007	L87YC	0.6		
-------------	----------	--------	--------------	-------	-----	--	--

HONDA

50cc	CHF50 Metropolitan II, CHF50P Metropolitan	2002 →2005		G59C	0.9	8698	
	Joker SRX50T	1997 →		RL86C	0.5		
	NB		OE091	RN2C	0.6	8904	PRO-5M
	NB Melody (AB07)	1984 →	OE064	RL82YC	0.8	8814	PRO-5M
	NH M (AF01)	1985 →1987	OE064	RL82YC	0.8	8814	PRO-5M
	NH MS Lead	1993 →	OE064	RL82YC	0.8	8814	PRO-5M
	NPS50, Ruckus	2003 →2005		G59C	0.9	8698	
	NQ50, D, H	1984 →1987		RL87YC	0.8		
	PK DX Wallaroo Mofa (AB25)	1992 →		RL86C	0.6		PRO-5M
	PX (AB06)	1984 →		RL86C	0.6		PRO-5M
	PX E (AB06)	1980 →1986	OE064	RL82YC	0.8	8814	PRO-5M
	PX R (AB06)	1985 →	OE064	RL82YC	0.8	8814	PRO-5M
	PXR			RL86C	0.6		PRO-5M
	SA 50 (AF29)			RL86C	0.7		PRO-5M
	SA 50 Vision	1988 →1990		RL87YC	0.6		PRO-5M
	SA 50 Vision	1991 →		RL87YC	0.6		PRO-5M
	SFX (AF37)	1996 →		RL86C	0.6		PRO-5M
	SGX Sky	1997 →		RL86C	0.6		PRO-5M
	SH	1996 →		RL86C	0.5		PRO-5M
	SH City Express (AF29)	1991 →		RL86C	0.6		PRO-5M
	SH Scoopy Roller (SH50)	1985 →1991	OE064	RL82YC	0.8	8814	PRO-5M
	SH Vision Roller	1984 →	OE064	RL82YC	0.7	8814	PRO-5M
	Shadow 50	1997 →		RL86C	0.6		
	SJ Bali Roller (AF32)	1994 →	OE064	RL82YC	0.8	8814	PRO-5M
	Sky	1997 →		RL86C	0.6		
	Sky Vetro	2000 →		RL86C	0.6		
	SXR 50 W	1998 →		RL86C	0.6		PRO-5M



**21****POWER SPORT****...HONDA**

...50cc	SZX 50 X8R-S/X	1998 →		RL86C	0.6		
	X8R-S	1998 →		RL86C	0.6		
	X8R-X	1998 →		RL86C	0.6		
80cc	NH (HF01)	1984 →	OE064	RL82YC	0.8	8814	PRO-5M
90cc	SRX Shadow	1998 →		RL86C			
100cc	SCV 100 Lead	2003 →		P-RZ9HC	0.7		
	SH Scoopy	1997 →		RL87YC			
	SJ EX Bali (HF07)	1996 →	OE064	RL82YC	0.6	8814	
125cc	@ 125	2000 →		RGU94C	0.9	8698	
	ANF 125 i Innova	2007 →		RG6YC	0.9		
	CH Spacy			P-RA7HC	0.9	8812	
	Dylan 125	2002 →		RGU94C	0.9	8698	
	FES 125 Pantheon (JF05) 2 stroke	1998 →	OE108	RN3C	0.7	8904	
	FES 125 Pantheon 4 stroke	2003 →		RGU94C	0.9	8698	
	NH, Lead	1983 →	OE064	RL82YC	0.8	8814	
	Pantheon FES	1997 →	OE091	RN2C	0.6	8904	
	SH 125 Scoopy Scooter	2001 →		RGU94C		8698	
	Spacy CH 125 (JS03)	1997 →		P-RA7HC	0.9	8812	
150cc	SH 150i	2006 →		RGU94C	0.9	8698	
	SH 150i	2007 →		RGU94C	0.9	8698	
	S-Wing	2007 →		RGU94C	0.9	8698	
250cc	CN Helix	1986 →1987	OE083	RA6HC	0.6	8809	
	CN Roller (MF02)	1991 →	OE083	RA6HC	0.9	8809	
	CN Roller		OE083	RA6HC	0.6	8809	
	FE Forsight	1997 →1999	OE083	RA6HC	0.6	8809	
	FE Forsight	2000 →	OE083	RA6HC	0.6	8809	
	FES (MF04)	1997 →		P-RA7HC	0.9	8812	
	NSS250, Reflex, ABS	2002 →2005		RA8HC	0.9	8812	
	Reflex Sport, ABS (Liquid)	→2005		RA8HC	0.9	8812	
	S-Wing	2005 →		P-RA7HC	0.9	8812	
400cc	Silverwing 400	2006 →		RGU94C	0.9	8698	
600cc	Silver Wing 600	2001 →		RGU94C	0.9	8698	
	Silver Wing ABS (G2)	2003 →		RGU94C	0.9	8698	
	Various	2004 →		RZ96C	0.9		

HYOSUNG

50cc	Avanti 50 (SD50)	1999 →	OE038	L82YC	0.6	8814	PRO-5U
	Cab 50 (SB50G)	1995 →	OE038	L82YC	0.6	8814	
	Gamma 50 (SB50G)	1997 →	OE038	L82YC	0.6	8814	
	Prima			RL78C	0.6	8883	
	SD (Air cooled)	1999 →	OE007	L87YC			
	SD Sense (Air cooled)	1999 →	OE007	L87YC			
	SF	1999 →		RL78C	0.6	8883	PRO-5U
	SF Rally 50	2004 →		RL78C	0.6	8883	PRO-5U
	ST 50 L, Cap 50		OE064	RL82YC	0.6	8814	PRO-5U
	Supercab	2005 →		RL78C	0.6	8883	PRO-5U
100cc	EZ (Air cooled)	2000 →	OE038	L82YC	0.7	8814	
	Supercab (EZ100)	1997 →	OE007	L87YC	0.6		PRO-5U
125cc	Boomer 125	2002 →	OE083	RA6HC	0.6	8809	
	Grand Prix (Air/Oil cooled)	1999 →	OE083	RA6HC	0.8	8809	
	Grand Prix Plus (Air/Oil cooled)	1999 →	OE083	RA6HC	0.8	8809	

**21****POWER
SPORT****ITALJET**

50cc	Ascot		OE038	L82YC	0.5	8814
	Bazooka 1+2		OE038	L82YC	0.5	8814
	Cruise		OE038	L82YC	0.5	8814
	Dragster (Liquid cooled)	1998 →	OE091	RN2C	0.6	8904
	Dragster 50	1996 → 1997	OE064	RL82YC	0.6	8814
	Dragster 50	1997 → 1998	OE064	RL82YC	0.6	8814
	Fastboy	1998 →	OE086	RL82C	0.6	8814
	Formula (Air cooled)	2000 →		RL87YC	0.6	
	Formula LC (Liquid cooled)	2000 →		RL87YC	0.6	
	Formula Race, Williams	1996 →	OE038	L82YC	0.5	8814
	Formula Race, Williams		OE038	L82YC	0.5	8814
	Pista 1+2		OE038	L82YC	0.5	8814
	Reporter	1990 →	OE038	L82YC	0.6	8814
	Scoop		OE038	L82YC	0.5	8814
	Sunny		OE038	L82YC	0.5	8814
	Torpedo 2T			L82C	0.6	8814
	Torpedo 25 (Air cooled)	1997 →	OE086	RL82C	0.5	8814
	Torpedo 4T			RG96C	0.6	8698
	Torpedo 50	1998 →	OE086	RL82C	0.6	8814
	Velocifero (Air cooled)	1994 →	OE064	RL82YC	0.7	8814
	Velocifero "8", "10"	1998 →		RL78C	0.6	8883
	Yankee		OE038	L82YC	0.5	8814
100cc	Millenium 100		OE086	RL82C	0.6	8814
125cc	Dragster (Liquid cooled)	2000 →	OE091	RN2C	0.6	8904
	Formula		OE038	L82YC	0.5	8814
	Formula (Liquid cooled)	2000 →		RL86C	0.6	
	Jet Set			RG96C	0.6	8698
	Jupiter			RG94C	0.7	8698
	Millennium (Liquid cooled)	2000 →		RG94C	0.8	8698
	Torpedo	2000 →		RG96C		8698
	Torpedo	1999 →	OE092	RG4HC	0.7	8698
150cc	Jet Set			RG96C	0.6	8698
	Jupiter			RG94C	0.7	8698
	Millenium			RG94C	0.7	8698
	Torpedo	2000 →		RG96C	0.7	8698
180cc	Dragster (Liquid cooled)	2000 →	OE040	N2C	0.6	8904
250cc	Jupiter		OE083	RA6HC	0.6	8809
	Millenium	1999 →	OE083	RA6HC	0.6	8809

ITTECO

50cc	Hornet		OE038	L82YC	0.6	8814
-------------	--------	--	--------------	-------	-----	------

JAWA/ CZ

49cc	Jawa		OE037	L86C	0.5	
-------------	------	--	--------------	------	-----	--

KINETIC

50cc	Pride		OE038	L82YC	0.6	8814
-------------	-------	--	--------------	-------	-----	------

80cc	Pride		OE038	L82YC	0.6	8814
-------------	-------	--	--------------	-------	-----	------

**KINETIC**

**21****POWER SPORT****KREIDLER**

50cc	Florett RMC 25	2005 →	OE064	RL82YC	0.6	8814	
	Florett RMC 50	2005 →	OE064	RL82YC	0.6	8814	
	Florett XL 25		OE064	RL82YC	0.6	8814	
	Florett XL 50		OE064	RL82YC	0.6	8814	
	Florett 25	1996 →	OE064	RL82YC	0.6	8814	
	Florett 50	1996 →	OE064	RL82YC	0.6	8814	
	Flory 1cyl.4 stroke	2005 →		Z9Y	0.6		
	Flory 25	1996 →	OE064	RL82YC	0.6	8814	
	Flory 50	1996 →	OE064	RL82YC	0.6	8814	
	Flory RC 25	2005 →	OE064	RL82YC	0.6	8814	
	Flory RC 50	2005 →	OE064	RL82YC	0.6	8814	
	MK	1996 →	OE064	RL82YC	0.6	8814	

125cc	Florett RMC 125	2005 →		RZ96C	0.5		
	Flory 125 4Takt			RZ96C	0.5		

KTM

50cc	Chrono	1993 →	OE086	RL82C	0.6	8814	PRO-5M
	Go	1993 →	OE086	RL82C	0.6	8814	PRO-5M
	K 50 (I)		OE086	RL82C	0.5	8814	PRO-5M

KYMCO

50cc	Agility 50	2005 →		RZ96C	0.5		
	Calypso 50	1997 →		RL78C	0.6	8883	
	Cobra Cross (Air cooled)	2000 →		RL78C	0.5	8883	PRO-5M
	Cobra Racer (Air cooled)	2000 →		RL78C	0.5	8883	PRO-5M
	CSX 50			RL78C	0.6	8883	
	Curio	1994 →1995		RL78C		8883	
	Curio	1996 →		RL78C		8883	
	CX			L78C	0.5	8883	
	CX S			L78C	0.5	8883	
	Dink	1997 →		RL78C	0.5	8883	
	Dink 50 2 stroke	1999 →		RZ96C	0.5		
	DJW			L78C	0.5	8883	
	DJX	1992 →		RL78C	0.5	8883	
	DJY	1993 →		RL78C	0.5	8883	
	Fever ZX			L78C	0.5	8883	PRO-5M
	Filly (Air cooled)	1998 →		RZ96C	0.7		
	Grand Dink 50	2005 →		RL78C	0.6	8883	
	GY50 (Changzhou)			P-RZ9HC			
	Heroism			L78C	0.5	8883	PRO-5M
	K12			L78C	0.5	8883	PRO-5M
	KB	1994 →		RL78C	0.5	8883	
	People	1999 →		RL78C	0.6	8883	
	Scout	1996 →		RL78C		8883	PRO-5M
	Sniper			L78C	0.5	8883	
	Spacer (Air cooled)	2000 →		RL78C	0.5	8883	
	Super 9 AC	2001 →		RL78C	0.6	8883	PRO-5M
	Super 9 LC	2001 →		RL78C	0.6	8883	PRO-5M
	Tomos TX	2001 →	OE037	L86C	0.6		
	Top Boy, Racer, Executive	1997 →		RL78C	0.5	8883	PRO-5M
	Top Racer, Cross	2001 →		RL78C	0.5	8883	PRO-5M
	Vitality 50 2 stroke	2005 →		RL78C	0.6	8883	
	Vitality 50 4 stroke	2005 →		RZ96C	0.5		
	Yager 50	2001 →		RL78C	0.6	8883	PRO-5M
	YUP 50	2000 →		RL78C	0.6	8883	
	ZX (Air cooled)	2000 →		RL78C	0.6	8883	

**21****POWER SPORT****...KYMCO**

100cc	Cobra Racer (Air cooled)	2000 →		RL86C	0.6		PRO-5M
	Top Boy	1997 →		RL78C	0.6	8883	PRO-5M
110cc	C110 (Changzhou)			P-RZ9HC			
125cc	Agility 125	2005 →		RZ96C	0.7		
	Calypso 125	1997 →		Z9Y	0.6		
	CG125 (Changzhou)			P-RA7HC		8812	
	CK	2004 →	OE083	RA6HC	0.7	8809	
	Dink	1997 →		RZ96C	0.7		
	Grand Dink 125	1999 →		P-RA7HC	0.9	8812	
	Heroism			Z6	0.5		
	Hipster 2v		OE083	RA6HC	0.7	8809	
	Hipster 4v	2001 →		RG94C	0.6	8698	
	Movie 125			Z9Y	0.6		
	People	1999 →		Z9Y			
	Pulsar	2001 →	OE083	RA6HC	0.7	8809	
	Spacer (Liquid cooled)	1998 →		P-RA7HC	0.9	8812	
	Yager 125	2001 →		P-RA7HC	0.9	8812	
	Zing (Air/Oil cooled)	2000 →	OE083	RA6HC	0.9	8809	
150cc	CG150 (Changzhou)			P-RA7HC		8812	
	Dink	1997 →		P-RA7HC	0.9	8812	
	Heroism			Z6	0.5		
250cc	Dink 250	1999 →		P-RA7HC	0.9	8812	
	Grand Dink 250	1999 →		P-RA7HC	0.9	8812	
	People 250	2005 →		P-RA7HC	0.9	8812	
	Xciting 250	2005 →		P-RA7HC	0.9	8812	
500cc	Xciting 500	2005 →		RG94C	0.7	8698	
	CBT (Changzhou)			P-RZ9HC			
	GY6 (Changzhou)			P-RZ9HC			

K-ZWO

50cc	Cat 50	1997 →	OE086	RL82C	0.6	8814	
	K-zwo VIVA 50/25		OE086	RL82C	0.5	8814	
	Motron Sting		OE086	RL82C	0.5	8814	
	Motron Thunder		OE086	RL82C	0.5	8814	
	Siamoto Falcon			Z9Y	0.6		
	Siamoto Scross			Z9Y	0.6		
125cc	K-Zwo Appache		OE083	RA6HC	0.6	8809	
	K-Zwo Royal 125	1996 →		Z9Y	0.6		
	Royal 125	1996 →		Z9Y	0.6		

LAMBRETTA

50cc	3V77/4V/5V		OE037	L86C	0.5		
	Puma Cross,Trial		OE037	L86C	0.5		
125cc	125,Lince,Linea,SX		OE079	N4C	0.5	8339	
	Scooter		OE098	RN4C	0.5	8339	
150cc	150 GP		OE079	N4C	0.5	8339	
	Scooter		OE098	RN4C	0.5	8339	
	Spezial 150		OE079	N4C	0.5	8339	
200cc	200 GP		OE079	N4C	0.5	8339	
	200,Jet,Lince,Mensa-Expres		OE079	N4C	0.5	8339	
	Pony,SX		OE079	N4C	0.5	8339	
	Scooter		OE098	RN4C	0.5	8339	

**LAMBRETTA**

**21****POWER SPORT****LECSO**

50cc	LTS BW		OE007	L87YC	0.5		
	LTS TR		OE007	L87YC	0.5		

LEM

50cc	Flash (I)		OE086	RL82C	0.6	8814	
	Ghibli (I)		OE086	RL82C	0.6	8814	

LML- VESPA

125cc	NV 125 SPL		OE087	N6YC	0.6	8902	
150cc	NV 150 SPL		OE087	N6YC	0.6	8902	
200cc	NV 200 SPL		OE074	N5C	0.6	8339	

MACAL

50cc	GTX	1998 →	OE086	RL82C	0.6	8814	
	MY 50	1999 →	OE086	RL82C	0.6	8814	
	New Star	1998 →	OE086	RL82C	0.6	8814	
	Star Flight	1998 →	OE086	RL82C	0.6	8814	
	Trophy	1998 →	OE108	RN3C	0.6	8904	

MALAGUTI

50cc	Centro		OE086	RL82C	0.5	8814	
	Centro SL	1992 →	OE038	L82YC	0.5	8814	
	Ciak			RL78C	0.5	8883	
	CR 1	1995 →	OE064	RL82YC	0.5	8814	
	Crosser CR1			RL87YC	0.5		
	ET		OE037	L86C	0.6		
	F10 Jet Line (Air cooled)	1992 →	OE038	L82YC	0.5	8814	
	F-11			RL78C	0.5	8883	
	F12 Phantom	1994 →	OE086	RL82C	0.5	8814	
	F12 Phantom	1998 →	OE086	RL82C	0.5	8814	
	F12 Phantom (Liquid cooled)	1995 →		RL78C	0.5	8883	
	F15 Firefox (Liquid cooled)	1998 →	OE086	RL82C	0.5	8814	
	Grizzly 12		OE037	L86C	0.5		
	Grizzly Ranocchio		OE037	L86C	0.5		
	Grizzly RCW4, RCW50, RCX10, RCX50	1999 →		L82C	0.6	8814	
	Phantom F12 (Liquid cooled)			QL78C	0.5	8883	
	Phantom F12			RL78C	0.5	8883	
Phantom F12 LC	1996 →		RL78C	0.5	8883		
Yesterday (Air cooled)	1998 →	OE086	RL82C	0.6	8814		
70cc	F15 Firefox (Liquid cooled)	2000 →		RL78C	0.5	8883	
	Yesterday Euro (Air cooled)	2000 →		RL78C	0.5	8883	
125cc	Ciak 125			RZ96C	0.7		
	Madison (Liquid cooled) (Yamaha/Minarelli)	1999 →		RG96C	0.7	8698	
150cc	Ciak	2000 →		RZ96C			
	Madison (Liquid cooled) (Yamaha/Minarelli)	1999 →		RG96C	0.7	8698	
200cc	F-12 Phantom Max 200	2004 →		RG94C	0.6	8698	
	Madison S 200	2003 →		RG94C	0.6	8698	
250cc	Madison S (Liquid cooled) (Yamaha)	1999 →	OE083	RA6HC	0.6	8809	
400cc	Madison 400	2003 →	OE092	RG4HC	0.7	8698	
500cc	Spidermax 500 GT	2004 →		RG6YC	0.6		

MARS

50cc	MK 50			RL87YC	0.6		
	MK 50/1		OE007	L87YC	0.6		
	SM 50		OE007	L87YC	0.6		
	SM 50/1		OE007	L87YC	0.6		

**21****POWER
SPORT****MBK**

49cc	Active		OE064	RL82YC	0.5	8814	PRO-5M
50cc	Active 50 (I)		OE086	RL82C	0.6	8814	PRO-5M
	Booster	1993 →	OE086	RL82C	0.5	8814	PRO-5M
	Booster			L78C	0.5	8883	PRO-5M
	Booster (CW50)	1997 →		RL78C	0.6	8883	PRO-5M
	Booster (3TX) (GB)		OE064	RL82YC	0.5	8814	PRO-5M
	Booster (4FG) (CH)			RL78C	0.5	8883	PRO-5M
	Booster 50 (I)	1990 →1994	OE064	RL82YC	0.6	8814	PRO-5M
	Booster CW50	→1994		L82C	0.5	8814	PRO-5M
	Booster CW50			L82C	0.5	8814	PRO-5M
	Booster CW50	1995 →		QL78C	0.5	8883	PRO-5M
	Booster N.G. 50 (I)			RL78C	0.6	8883	PRO-5M
	Booster NG CW50R,CW50RSP,CW50RSX			L78C	0.5	8883	PRO-5M
	Booster NG (CW50RS)	1997 →		RL78C	0.6	8883	PRO-5M
	Booster Original			L78C	0.5	8883	PRO-5M
	Booster R 50 (I)		OE086	RL82C	0.6	8814	PRO-5M
	Booster Road CW50R			L82C	0.5	8814	PRO-5M
	Booster Road CW50R			L78C	0.5	8883	PRO-5M
	Booster Rocket (CW50RSP)	1997 →		RL78C	0.6	8883	PRO-5M
	Booster Rocket CW50R,CW50RSP,CW50RSX			L78C	0.5	8883	PRO-5M
	Booster Spirit 50 (I)			RL78C	0.6	8883	PRO-5M
	Booster Track (CW50RSX)	1997 →		RL78C	0.6	8883	PRO-5M
	Booster Track CW50R,CW50RSP,CW50RSX			L78C	0.5	8883	PRO-5M
	CT 50 S - CT 50 SS (I)		OE038	L82YC	0.6	8814	
	Dakota	2005 →	OE086	RL82C	0.6	8814	
	Evalis (4FW)	1993 →	OE086	RL82C	0.5	8814	PRO-5M
	Evalis (4HU) (NL)			RL86C	0.5		PRO-5M
	Evalis 50 (I)	1992 →	OE086	RL82C	0.6	8814	PRO-5M
	Evalis 50 (YE50)	1997 →		RL78C	0.6	8883	PRO-5M
	Evalis YE50 (4FW)	1993 →		L82C	0.5	8814	PRO-5M
	Evalis YE50	1994 →		L78C	0.5	8883	PRO-5M
	Fizz	→1996		RL78C	0.5	8883	PRO-5M
	Fizz			L82C	0.5	8814	PRO-5M
	Fizz (YM50)	1997 →		RL78C	0.6	8883	PRO-5M
	Fizz 50 (I)	1994 →	OE086	RL82C	0.6	8814	PRO-5M
	Fizz YM50	1995 →		L78C	0.5	8883	PRO-5M
	Flipper			RL78C	0.6	8883	PRO-5M
	Flipper	1998 →		RL78C		8883	PRO-5M
	Forte (3UG)	1996 →		L78C	0.6	8883	PRO-5M
	Forte (3UG)	1996 →		RL78C	0.6	8883	PRO-5M
	Forte (YA50R)	1997 →	OE086	RL82C	0.5	8814	PRO-5M
	Forte 50 (I)	1994 →	OE086	RL82C	0.6	8814	PRO-5M
	Kansas	2005 →	OE086	RL82C	0.6	8814	
	Mach G			RL78C	0.6	8883	
	Mach G LC 50			RL78C	0.6	8883	
	New Sorriso 50 (I)	1995 →	OE038	L82YC	0.6	8814	
	Nitro	1997 →		RL78C	0.6	8883	PRO-5M
	Nitro (Liquid cooled)	2001 →		RL78C	0.6	8883	PRO-5M
	Nitro F1 "Mac Laren"	2000 →		RL78C	0.6	8883	PRO-5M
	Nitro Jaguar F1 replica	1997 →		RL78C	0.5	8883	PRO-5M
	Ovetto	1997 →	OE086	RL82C	0.6	8814	PRO-5M
	Ovetto	1997 →	OE086	RL82C	0.5	8814	PRO-5M
	Phönix	2005 →	OE086	RL82C	0.6	8814	
	Sorriso		OE038	L82YC	0.6	8814	PRO-5M

**MBK**

**21****POWER
SPORT****...MBK**

Capacity	Model	Year	OE Part	Part No.	Gap (mm)	Part No.	Part No.
...50cc	Sorriso 50 (I)		OE038	L82YC	0.6	8814	PRO-5M
	Stunt	2000 →		QL77JC4		8883	
	Stunt 50	2003 →		RL78C	0.6	8883	
	Target		OE038	L82YC	0.6	8814	PRO-5M
	Target 50 (I)		OE038	L82YC	0.6	8814	PRO-5M
	X-Limit	2005 →	OE091	RN2C	0.7	8904	
	X-Limit	1998 →	OE040	N2C	0.6	8904	
80cc	Evolis (4MU)	1995 →		L82C	0.5	8814	PRO-5M
	Evolis (4MU)(YE80)	1996 →	OE086	RL82C	0.7	8814	PRO-5M
	Zest (4MU)		OE086	RL82C	0.7	8814	
100cc	Nitro	2000 →		RL78C		8883	
	Nitro 100			RL78C	0.6	8883	
	Ovetto	2000 →		RL78C		8883	
	Ovetto 100			RL78C	0.6	8883	
125cc	Doodo 4T			RG94C	0.7	8698	
	Doodo Scooter	2001 →		RG94C		8698	
	Flame (4NB)			RG96C	0.6	8698	
	Flame (XC125R)			RG96C	0.6	8698	
	Flame (XC125T)			RG96C	0.6	8698	
	Flame R (4NB)	1996 →		RG96C	0.6	8698	
	Flame R XC125R	1996 →		RG96C	0.6	8698	
	Flame XC125 T, R			G59C	0.6	8698	
	Flame XC125T			G59C	0.6	8698	
	Skycruiser 125	2006 →	OE092	RG4HC		8698	
	Skyliner	1998 →		RG94C	0.7	8698	
	Skyliner	1998 →	OE083	RA6HC	0.7	8809	
	Thunder 125 4T			RG94C	0.7	8698	
XC 125 Flame (I)	1995 →		RG96C	0.7	8698		
XC 125 Flame (I)	→1994		P-RZ9HC	0.7			
150cc	Skyliner	2000 →		RG96C	0.7	8698	
	Vertex 150 (I)			RG96C	0.7	8698	
250cc	Skyliner	1999 →	OE083	RA6HC	0.7	8809	
300cc	Kilibre 300	2003 →	OE083	RA6HC	0.9	8809	
400cc	Skyliner 400	2004 →		RG96C	0.7	8698	

MIDWEST

Panda

Z6

0.8

MINARELLI

50cc	BWS		OE038	L82YC	0.8	8814	
------	-----	--	--------------	-------	-----	------	--

MOTOBECANE (MBK/ Yamaha)

49cc	Moby 12,7mm/1/2in.		OE037	L86C	0.4		
	Moby 19mm/3/4in.			RN5C	0.4	8339	

MOTOTECHNIKA

200cc	Motoroller Myravey 1973		OE007	L87YC	0.7		
-------	-------------------------	--	--------------	-------	-----	--	--

MOTRON

50cc	Spike (I)		OE086	RL82C	0.6	8814	
	Sting 50	1996 →	OE086	RL82C	0.6	8814	
	Sting 50 (I)		OE086	RL82C	0.6	8814	
	Syncro (I)		OE086	RL82C	0.6	8814	
	Thunder 50	1996 →	OE086	RL82C	0.6	8814	
	Thunder S 50 (I)		OE086	RL82C	0.6	8814	

**21****POWER
SPORT****MSA**

50cc	MX			RL78C	0.5	8883	
	RC	1999 →	OE108	RN3C	0.6	8904	
	RC SM	1999 →	OE108	RN3C	0.6	8904	
	RC Trophy Yacco	2000 →	OE108	RN3C	0.6	8904	
	RSE	1999 →	OE108	RN3C	0.6	8904	
	RTW	2000 →	OE108	RN3C	0.6	8904	
	SM	2001 →	OE108	RN3C	0.6	8904	

MZ

50cc	Moskito 50 RX (EG Country)	2002 →		RL78C	0.6	8883	
	Moskito 50 SX (CPI50C)	1999 →	OE086	RL82C	0.6	8814	
	Moskito 50RX (not EG Country)	2002 →	OE064	RL82YC	0.6	8814	
	Moskito FB 50	1997 →	OE086	RL82C	0.6	8814	

125cc	Moskito 125	2001 →		RZ96C	0.6		PRO-5M
--------------	-------------	--------	--	-------	-----	--	--------

NSU

175cc	Lambretta			L82C	0.5	8814	
--------------	-----------	--	--	------	-----	------	--

OTTO

50cc	Fashion	1996 →		RL78C	0.6	8883	
	GTX	1996 →	OE086	RL82C	0.6	8814	

PEGASUS

50cc	Corona 25		OE064	RL82YC	0.5	8814	
	Corona 50		OE064	RL82YC	0.5	8814	
	Skipper 25		OE064	RL82YC	0.5	8814	
	Skipper 50		OE064	RL82YC	0.5	8814	
	Sky 25		OE064	RL82YC	0.5	8814	
	Sky 25 High Wheels		OE064	RL82YC	0.5	8814	
	Sky 50		OE064	RL82YC	0.5	8814	
	Sky 50 High Wheels		OE064	RL82YC	0.5	8814	
	Solero 25		OE064	RL82YC	0.5	8814	
	Solero 50		OE064	RL82YC	0.5	8814	

125cc	Corona Comfort Edition			RZ96C	0.6		
	Corona Sport Edition			RZ96C	0.6		
	Skipper			RZ96C	0.7		
	Sky			RZ96C	0.7		

PEUGEOT

50cc	Buxy	1997 →		L82C	0.5	8814	
	Buxy R (Air cooled)	1995 → 1997		L78C	0.6	8883	
	Elyseo	1996 →		L82C	0.5	8814	
	Elystar TSDI			RG96C	0.6	8698	
	Jetforce C-Tech	2006 →		RG96C	0.6	8698	
	Jetforce TSDI	2005 →		RG96C	0.6	8698	
	Looxor Vergaser	2001 →	OE086	RL82C	0.6	8814	
	Looxor 50 TSDI			RG6YC	0.6		
	Ludix Blaster	2004 →	OE086	RL82C	0.7	8814	
	Ludix Classic	2004 →	OE086	RL82C	0.6	8814	
	Ludix Elegance	2004 →	OE086	RL82C	0.6	8814	
	Ludix One	2004 →	OE086	RL82C	0.7	8814	
	Ludix Snake	2004 →	OE086	RL82C	0.7	8814	
	Ludix Tend	2004 →	OE086	RL82C	0.7	8814	
	Metal-X 50		OE086	RL82C	0.6	8814	
	Rapido 2, 3			RL86C			
	Speedake			L82C	0.6	8814	
	Speedake (Air cooled)	1995 →		L78C	0.5	8883	
	SpeedFight LNDP,X-Race,X-Team (Air cooled)	1997 →		L82C	0.5	8814	PRO-5U

**PEUGEOT**

**21****POWER SPORT****...PEUGEOT**

Capacity	Model	Year	Part No.	Thread	Gap (mm)	Part No.	Part No.
...50cc	SpeedFight NP,X-Race,X-Team (Liquid cooled)	1997→	L82C	0.5	8814	PRO-5U	
	Squab	1997→	L82C	0.5	8814		
	ST	1991→	RL86C	0.5			
	SV	1997→	L82C	0.5	8814	PRO-5U	
	SV	→1997	L78C	0.5	8883	PRO-5U	
	TKR Streetboard 50 / WRC	2000→	OE086 RL82C	0.6	8814		
	Trekker Road	1997→	OE086 RL82C	0.5	8814	PRO-5U	
	Trekker Streetboard, Off road (Air cooled)	1997→	OE086 RL82C	0.5	8814	PRO-5U	
	Trekker Urban Black	1999→	OE086 RL82C	0.5	8814	PRO-5U	
	Vivacity (Air cooled)	1998→	RL86C	0.6			
	Vivacity Sportline (Air cooled)	1998→	RL86C	0.6			
	Zenith (Air cooled)	1995→	RL86C	0.6			
	Zenith A, L, MA	1997→	OE086 RL82C	0.5	8814		
	Zenith LM, LM2 (Air cooled)	1995→	L78C	0.6	8883		
80cc	SV		RL78C	0.5	8883		
100cc	Elyseo	1999→	OE108 RN3C	0.6	8904	PRO-5M	
	Looxor 100	2001→	OE108 RN3C	0.6	8904		
	Speedfight NP ,X-Race (Air cooled)	1997→	OE068 N3C	0.5	8904	PRO-5U	
	SV ,L	1997→	OE108 RN3C	0.5	8904	PRO-5U	
	TKR 100	2000→	OE108 RN3C	0.6	8904		
	Trekker	1998→	OE068 N3C	0.5	8904	PRO-5U	
	Vivacity	1999→	OE068 N3C	0.5	8904	PRO-5M	
125cc	Elyseo	1999→		RG94C	0.7	8698	
	Elyseo (Liquid cooled)		OE108	RN3C	0.5	8904	
	Elystar 125			RG94C	0.7	8698	
	Elystar ABS/PBS 125			RG94C	0.7	8698	
	Geopolis 125	2006→		RG96C	0.6	8698	
	Jet Force 125	2003→		RG96C	0.6	8698	
	Jet Force 125 Compressor	2005→		RG94C	0.7	8698	
	Looxor 125			RG96C	0.6	8698	
	Ludix 125	2004→		RG96C	0.6	8698	
	Satelis 125	2004→		RG96C	0.6	8698	
	Satelis 125 Kompressor	2006→		RG96C	0.6	8698	
SV		OE007	L87YC	0.5			
150cc	Elyseo (Liquid cooled)			L82C	0.5	8814	
	Elystar 150			RG96C	0.7	8698	
	Looxor 150			RG96C	0.6	8698	
250cc	Satelis 250	2006→		RG96C	0.6	8698	
	SV 250	2001→		P-RA7HC	0.9	8812	

PEUGEOT MOVESA

50cc	All mopeds		OE037	L86C	0.5		
-------------	------------	--	--------------	------	-----	--	--

PGO

50cc	Big Max 25/50		OE064	RL82YC	0.5	8814	PRO-5M
	Big Max 50		OE064	RL82YC	0.5	8814	PRO-5M
	Big Max Sport		OE038	L82YC	0.5	8814	PRO-5M
	Comet 2		OE038	L82YC	0.5	8814	PRO-5M
	Comet 25		OE038	L82YC	0.5	8814	PRO-5M
	Galaxy		OE038	L82YC	0.5	8814	PRO-5M
	G-Max	2004→	OE064	RL82YC	0.6	8814	
	Mega 50	1996→	OE064	RL82YC	0.5	8814	PRO-5M
	New Galaxy 50 (I)		OE038	L82YC	0.6	8814	
	PMS 50	1999→	OE007	L87YC	0.6		PRO-5M
	PMX	1999→	OE038	L82YC	0.6	8814	PRO-5M

**21****POWER
SPORT****...PGO**

...50cc	Road 66	1994 →	OE038	L82YC	0.7	8814	
	Rodoshow	2000 →	OE007	L87YC	0.6		PRO-5M
	Star		OE059	L92YC	0.5		PRO-5M
	Star 2		OE059	L92YC	0.5		PRO-5M
	Super Comet 50 (I)		OE007	L87YC	0.6		
	Tornado	1997 →	OE064	RL82YC	0.7	8814	PRO-5M
	T-REX	1999 →	OE038	L82YC		8814	PRO-5M
75cc	Galaxy 90		OE038	L82YC	0.5	8814	
80cc	Big Max 1.25	1996 →	OE064	RL82YC	0.7	8814	
	Star		OE038	L82YC	0.5	8814	PRO-5M
82cc	Big Max 90	1996 →	OE064	RL82YC	0.5	8814	PRO-5M
90cc	Galaxy	1992 →	OE064	RL82YC	0.7	8814	
125cc	G-Max	2005 →		Z9Y	0.7		
	Tornado		OE064	RL82YC	0.7	8814	
	T-REX	1998 →	OE038	L82YC	0.7	8814	PRO-5M
	T-REX	1998 →		RZ96C	0.7		

PHANTOM

w/U.S.Engs. 21/25

w/U.S.Engs. 35/41

RCJ7Y 0.7

RCJ8Y 0.7

PIAGGIO / VESPA

25cc	Free 25 Mofa		OE087	N6YC	0.5	8902	PRO-5M
	Storm		OE037	L86C	0.5		PRO-5M
	Zip 25 Mofa		OE116	RN6YC	0.5	8902	PRO-5M
	Zip Base 25 / Mofa		OE116	RN6YC	0.5	8902	PRO-5M
50cc	50 R, Special		OE037	L86C	0.5		PRO-5M
	50 S		OE037	L86C	0.5		PRO-5M
	Ape 50, 50 RST, Cross			RL78C	0.7	8883	
	Ape Poker		OE109	N6BYC	0.6	8902	
	Boss		OE037	L86C	0.5		PRO-5M
	Boxer		OE037	L86C	0.5		
	Bravo			RL78C	0.5	8883	PRO-5M
	Ciao			RL78C	0.5	8883	PRO-5M
	Custom		OE037	L86C	0.5		PRO-5M
	Diesis 50		OE091	RN2C	0.7	8904	
	Eaglet		OE040	N2C	0.5	8904	PRO-5M
	Easy Moving		OE040	N2C	0.5	8904	
	ET2 (carbureter/Vergaser)	1998 →	OE091	RN2C	0.6	8904	
	ET2 (iniezione / Einspritzer)	1998 →	OE073	RA4HC	0.6		
	Fast Rider		OE091	RN2C	0.5	8904	PRO-5M
	FL2			L78C	0.5	8883	
	Fly 50 2T	2006 →	OE091	RN2C	0.6	8904	
	Fly 50 4T	2006 →	OE122	RG4PHP		8698	
	Free		OE091	RN2C	0.7	8904	PRO-5M
	Free Kat		OE091	RN2C	0.7	8904	PRO-5M
	Free Business 50	1996 →	OE040	N2C	0.6	8904	
	Grillo			RL78C	0.5	8883	PRO-5M
	Liberty	1997 →	OE091	RN2C	0.6	8904	PRO-5M
	Liberty Kat		OE091	RN2C	0.7	8904	PRO-5M
	Liberty 4T	2002 →	OE092	RG4HC	0.8	8698	PRO-5M
	LX 4T	2006 →	OE122	RG4PHP		8698	
	MP Max		OE037	L86C	0.5		
	NRG +DD	1996 →		RN1C	0.5	8904	PRO-5M
	NRG MC Extreme		OE091	RN2C	0.5	8904	PRO-5M

**21****POWER
SPORT****...PIAGGIO / VESPA****...50cc**

NSP 4T (Aria)	2002 →	OE092	RG4HC	0.8	8698	
NTT (Liquid cooled)	1996 →	OE091	RN2C	0.6	8904	
PK			RL78C	0.5	8883	PRO-5M
PK S		OE086	RL82C	0.5	8814	PRO-5M
PK S Autom.		OE098	RN4C	0.5	8339	PRO-5M
PK S Elestart		OE037	L86C	0.5		PRO-5M
PK SS			L78C	0.5	8883	PRO-5M
PK XL		OE086	RL82C	0.5	8814	PRO-5M
Plurimatic		OE037	L86C	0.5		PRO-5M
PX 50		OE037	L86C	0.5		PRO-5M
Quartz		OE040	N2C	0.5	8904	PRO-5M
Rush		OE086	RL82C	0.5	8814	
Scatto		OE037	L86C	0.5		
Sfera		OE040	N2C	0.5	8904	PRO-5M
Si Mix		OE037	L86C	0.5		PRO-5M
Si Mofa Cantilever		OE037	L86C	0.5		PRO-5M
Si Moped Monte Carlo		OE037	L86C	0.5		PRO-5M
Sinerject	2002 →		RG6YCA			
Skipper		OE091	RN2C	0.5	8904	PRO-5M
Special		OE037	L86C	0.5		
Storm Autom.	1994 →	OE040	N2C	0.6	8904	PRO-5M
Super Bravo / Mofa		OE037	L86C	0.5		PRO-5M
Super Bravo 2 Gang / Mofa		OE037	L86C	0.5		PRO-5M
Torpedo	1997 →	OE040	N2C	0.5	8904	PRO-5M
TPH	1993 →	OE040	N2C	0.5	8904	PRO-5M
Typhoon 50 , 80 , 125 (Air cooled)		OE040	N2C	0.5	8904	
Velofax			RL78C	0.5	8883	PRO-5M
Velofax		OE087	N6YC	0.5	8902	PRO-5M
Velofax		OE068	N3C	0.5	8904	PRO-5M
Vespa		OE086	RL82C	0.5	8814	
Vespa ET2 Carburatore		OE040	N2C		8904	PRO-5M
Vespa ET2 Iniezione			RA59PP			PRO-5M
Vespa ET4		OE092	RG4HC	0.6	8698	
Vespa R			L78C	0.5	8883	PRO-5M
Vespa S		OE037	L86C	0.5		PRO-5M
Vespino	1997 →	OE091	RN2C	0.5	8904	PRO-5M
Vespino Velofax	1981 →1997	OE086	RL82C	0.5	8814	PRO-5M
Zip RST		OE091	RN2C	0.6	8904	PRO-5M
Zip Fast Rider		OE040	N2C	0.5	8904	PRO-5M
Zip Sport Production SP H20			RN1C	0.5	8904	PRO-5M
Zip Sport Production		OE091	RN2C	0.5	8904	PRO-5M
Zip Sport Production	1996 →		QN84	0.5		PRO-5M

75cc

PK S Primavera, T3 Prima			L82C	0.6	8814	PRO-5M
PK S, Elestart, Junior			L82C	0.6	8814	PRO-5M
PK XL, Elestart		OE040	N2C	0.6	8904	PRO-5M
SKR City		OE091	RN2C	0.6	8904	PRO-5M

80cc

PK			L78C	0.5	8883	PRO-5M
PK Lusso		OE086	RL82C	0.5	8814	PRO-5M
PK S		OE086	RL82C	0.5	8814	PRO-5M
PK S Autom.		OE037	L86C	0.5		PRO-5M
PX E		OE098	RN4C	0.5	8339	PRO-5M
PX E Lusso		OE098	RN4C	0.5	8339	PRO-5M
Sfera		OE091	RN2C	0.5	8904	PRO-5M
Sfera 80 Automatic		OE040	N2C	0.5	8904	PRO-5M

**21****POWER
SPORT****...PIAGGIO / VESPA**

Capacity	Model	Year	Part No.	Thread	Gap (mm)	Part No.	Notes
...80cc	Skipper		OE040	N2C	0.5	8904	
	TPH Autom	1994 →	OE091	RN2C	0.5	8904	PRO-5M
	Typhoon	1995 →	OE091	RN2C	0.5	8904	
	Vespa		OE098	RN4C	0.5	8339	PRO-5M
90cc	Vespa		OE086	RL82C	0.5	8814	PRO-5M
100cc	Diesis 100	2001 →		RG94C	0.6	8698	
	Free 100	2002 →		RG94C	0.6	8698	
	PK		OE086	RL82C	0.5	8814	PRO-5M
	PK 100 S	1982 →	OE086	RL82C	0.6	8814	PRO-5M
125cc	125 T5	1985 →	OE068	N3C	0.6	8904	PRO-5M
	Ape			L82C	0.5	8814	PRO-5M
	Beverly 125	2002 →		RG94C	0.6	8698	
	Cosa	→1990	OE040	N2C	0.5	8904	PRO-5M
	Cosa	1991 →1998	OE091	RN2C	0.5	8904	PRO-5M
	ET3		OE086	RL82C	0.5	8814	PRO-5M
	ET4 Automatic			RG96C	0.6	8698	PRO-5M
	Fly 125	2005 →		RG96C	0.6	8698	
	GTR		OE037	L86C	0.5		
	Hexagon	2001 →	OE092	RG4HC	0.7	8698	
	Hexagon 4T		OE040	N2C	0.5	8904	
	Hexagon 4T H2O		OE091	RN2C	0.6	8904	
	Hexagon LX			RG6YC	0.7		PRO-5M
	Hexagon Super GTX LX 4T		OE092	RG4HC	0.7	8698	
	Liberty	1998 →	OE092	RG4HC	0.7	8698	
	Liberty 4 stroke			RG96C	0.6	8698	
	LX2	1997 →	OE040	N2C	0.6	8904	
	LX4	1998 →		RG96C		8698	
	P ETS		OE037	L86C	0.5		PRO-5M
	P X		OE086	RL82C	0.5	8814	PRO-5M
	PK		OE086	RL82C	0.5	8814	PRO-5M
	PK Automatica		OE086	RL82C	0.5	8814	PRO-5M
	PK E		OE086	RL82C	0.5	8814	PRO-5M
	PK S	1984 →	OE086	RL82C	0.5	8814	PRO-5M
	PK S	→1983	OE037	L86C	0.5		PRO-5M
	Primavera		OE086	RL82C	0.5	8814	PRO-5M
	PX E		OE086	RL82C	0.5	8814	PRO-5M
	PX FL		OE086	RL82C	0.5	8814	PRO-5M
	Sfera	1995 →	OE092	RG4HC	0.6	8698	PRO-5M
	Skipper			RG6YC	0.7		PRO-5M
	Skipper 4T Leader		OE091	RN2C	0.5	8904	PRO-5M
	Skipper LX		OE091	RN2C	0.6	8904	PRO-5M
SKR 125	1993 →	OE040	N2C	0.5	8904	PRO-5M	
Super		OE037	L86C	0.5			
Super Hexagon GTX 125 4Stroke	2001 →		RG94C	0.6	8698		
TPH	1995 →	OE040	N2C	0.5	8904	PRO-5M	
TS		OE037	L86C	0.5			
Typhoon	1995 →	OE091	RN2C	0.5	8904	PRO-5M	
Vespa ET4	1996 →	OE092	RG4HC	0.6	8698	PRO-5M	
Vespa FL			L78C	0.5	8883	PRO-5M	
Vespa GT L i	2003 →	OE092	RG4HC	0.7	8698	PRO-5M	
Vespa P125CL	→1983	OE037	L86C	0.5		PRO-5M	
Vespa T5		OE091	RN2C	0.5	8904	PRO-5M	
X 8	2004 →		RG94C	0.6	8698		
X-9	2001 →	OE092	RG4HC	0.7	8698		

**PIAGGIO / VESPA**

**21****POWER SPORT****...PIAGGIO / VESPA**

...125cc	XL Plurimat Elestart			L82C	0.6	8814	
	Zip 125			OE092 RG4HC	0.6	8698	
150cc	Cosa			OE091 RN2C	0.5	8904	PRO-5M
	EX	1994 →		OE040 N2C	0.5	8904	PRO-5M
	Hexagon			OE040 N2C	0.5	8904	PRO-5M
	Liberty 4T Leader	1998 →		RG6YC	0.7		
	P S			OE037 L86C	0.5		PRO-5M
	P X			OE037 L86C	0.5		PRO-5M
	Piaggio			OE040 N2C	0.6	8904	
	PX E			OE037 L86C	0.5		PRO-5M
	PX FL			OE086 RL82C	0.5	8814	PRO-5M
	Skipper			RG6YC	0.7		PRO-5M
	Skipper 4T Leader			OE091 RN2C	0.5	8904	PRO-5M
	Skipper LXT			OE091 RN2C	0.6	8904	PRO-5M
	SKR 150	1998 →		OE040 N2C	0.5	8904	PRO-5M
	Vespa Sprint Veloce, Super			OE037 L86C	0.5		PRO-5M
	X9	2002 →		RG6YC	0.7		
175cc	Vespa			OE037 L86C	0.6		PRO-5M
180cc	Hexagon LXT	1998 →		OE091 RN2C	0.6	8904	PRO-5M
	Hexagon Super GTX	2001 →		OE092 RG4HC	0.7	8698	PRO-5M
	Vespa SS			OE037 L86C	0.5		PRO-5M
182cc	Hexagon Super GTX 4T H2O	2000 →		OE092 RG4HC	0.7	8698	PRO-5M
190cc	Ape			L82C	0.5	8814	PRO-5M
198cc	X9 200 Evolution	2003 →		RG6YC	0.7		
200cc	Beverly 200	2001 →		RG94C	0.6	8698	
	Cosa			OE108 RN3C	0.5	8904	PRO-5M
	DN			OE098 RN4C	0.5	8339	
	DS			OE098 RN4C	0.5	8339	
	PE Lusso			OE098 RN4C	0.5	8339	PRO-5M
	PX E			OE098 RN4C	0.5	8339	PRO-5M
	PX FL			OE098 RN4C	0.5	8339	PRO-5M
	Vespa GT L i	2003 →		RG6YC	0.7		
	Vespa Rally			OE098 RN4C	0.5	8339	PRO-5M
	X 8 200	2005 →		RG6YC	0.6		
220cc	Ape TM			RL78C	0.6	8883	PRO-5M
250cc	Beverly GT i.e.	2005 →		OE122 RG4PHP	0.6	8698	
	GTS i.e.	2005 →		OE122 RG4PHP	0.6	8698	
	Hexagon	1998 →		RA8HC	0.6	8812	
	Hexagon GT	1997 →		P-RA7HC	0.9	8812	PRO-5M
	Super Hexagon GTX 250			OE092 RG4HC	0.7	8698	
	X8 i.e.	2005 →		OE122 RG4PHP	0.6	8698	
	X9	2000 →		OE083 RA6HC	0.6	8809	
	X-9 (Honda)	2000 →		P-RA7HC	0.9	8812	PRO-5M
400cc	X-8	2006 →		RG6YC	0.7		
422cc	Ape Poker			OE077 RC7BYC4	0.7		
460cc	Beverly 500	2003 →		RG6YC	0.7		PRO-5M
	X9 500 4V i.e. Evolution	2003 →		RG6YC	0.7		PRO-5M
PUCH							
50cc	Lido SL 50			RL86C	0.6		PRO-5M
80cc	Lido SE			OE038 L82YC	0.6	8814	
125cc	Lido CD			OE083 RA6HC	0.6	8809	PRO-5M
QINGQI							
50cc	B2 2Stroke QM50QT-B2			OE007 L87YC	0.5		
125cc	10D GY6			Z9Y	0.6		
150cc	10D GY6			Z9Y	0.6		

**21****POWER
SPORT****RENAULT SPORT**

50cc	Campus	2001→	OE108	RN3C	0.6	8904	
	Spécimen	2001→		RL78C	0.6	8883	
100cc	Spécimen	2001→		RL78C	0.6	8883	
125cc	Fulltime	2001→	OE092	RG4HC	0.6	8698	
	Groomy	2001→	OE092	RG4HC	0.6	8698	
	Kouranos	2001→	OE092	RG4HC	0.6	8698	

REX

25cc	Rex 25		OE064	RL82YC	0.6	8814	
	Rexy 25	1996→	OE064	RL82YC	0.6	8814	
	Rexy 50	1996→	OE064	RL82YC	0.6	8814	
50cc	Rex 50	1996→	OE064	RL82YC	0.6	8814	
	Scooter	1996→	OE064	RL82YC	0.6	8814	
	Silver Star		OE064	RL82YC	0.6	8814	
	Silver Street		OE064	RL82YC	0.6	8814	
125cc	Rex 125	1997→		RZ96C	0.5		
	Rexy 125			RZ96C	0.5		

RIEJU

50cc	Drac (Air)		OE074	N5C	0.5	8339	
	Drac (Water)		OE079	N4C	0.5	8339	
	MRX	2003→	OE108	RN3C	0.7	8904	
	MX		OE037	L86C	0.5		
	NKD RS-2 Naked	2003→	OE108	RN3C	0.7	8904	
	RR AM6	2000→	OE108	RN3C	0.7	8904	PRO-5M
	RR Special Edition	2003→	OE108	RN3C	0.7	8904	
	RS-1		OE108	RN3C	0.7	8904	PRO-5M
	RS-1 Evolution	2000→	OE108	RN3C	0.7	8904	
	RS-2	2003→	OE108	RN3C	0.7	8904	
	SMX	2003→	OE108	RN3C	0.7	8904	
	Windy		OE086	RL82C	0.5	8814	
	125cc	MRX	2003→	OE108	RN3C	0.7	8904
SMX		2003→	OE108	RN3C	0.7	8904	

RIVERO

50cc	Linus 50		OE064	RL82YC	0.5	8814	
------	----------	--	--------------	--------	-----	------	--

ROYAL ENFIELD

125cc	Scooter		OE037	L86C			
-------	---------	--	--------------	------	--	--	--

SACHS

50cc	49er	2005→		RZ96C	0.5			
	Buxy (RS)			L82C	0.6	8814		
	City Roller CV		OE064	RL82YC	0.7	8814		
	Limbo		OE007	L87YC	0.6			
	Limbo Roller		OE007	L87YC	0.6			
	MadAss	2004→		RZ96C	0.6			
	Reggae (RS)			L82C	0.6	8814		
	Reggae RS Roller			L82C	0.6	8814		
	Samba SR			L78C	0.5	8883		
	Samba SR Roller			L78C	0.6	8883		
	Speedake			L82C	0.6	8814		
	Speedfight AC	1997→	OE086	RL82C	0.6	8814	PRO-5M	
	Speedfight LC	1997→	OE086	RL82C	0.6	8814	PRO-5M	
	Speedfight LC ADT	1997→	OE086	RL82C	0.6	8814	PRO-5M	
	Splinter			L82C	0.6	8814		
	Splinter Roller			OE038	L82YC	0.6	8814	
	Squab				RL78C	0.6	8883	

**SACHS**

**21****POWER
SPORT****...SACHS**

...50cc	SR			L78C	0.6	8883	
	SV			L78C	0.6	8883	
	SV Junior			L78C	0.6	8883	
	Zenith			OE007 L87YC	0.6		
80cc	City CV E Roller 32N	1982 →	OE064	RL82YC	0.6	8814	
	City CV Roller 14A	1982 →		L78C	0.6	8883	
	City Roller CV		OE064	RL82YC	0.7	8814	
	SR			L78C	0.6	8883	
	SV			L78C	0.6	8883	
125cc	SR		OE007	L87YC	0.6		PRO-5M
	SR C		OE007	L87YC	0.6		PRO-5M
	SR Roller	1994 →	OE007	L87YC	0.6		PRO-5M
	Superduke	1997 →		Z9Y	0.6		
	SV		OE007	L87YC	0.6		PRO-5M
	SV C		OE007	L87YC	0.6		PRO-5M
	SV Roller	1994 →	OE007	L87YC	0.6		PRO-5M

SAN YANG

50cc	Fancy 50	1995 →		RL78C	0.6	8883	
	Flash 50			RL78C	0.6	8883	
	Free 50			RL78C	0.6	8883	
	Jet 50			RL78C	0.6	8883	
	Mike 50			RL78C	0.6	8883	
	Pure 50			RL78C	0.6	8883	
	Red Devil 50			RL78C	0.6	8883	
	Super Fancy 50			RL78C	0.6	8883	
125cc	Duke 125			Z9Y	0.6		
	Super Duke 125			Z9Y	0.6		

SASY

50cc	Classic 200	1996 →	OE064	RL82YC	0.5	8814	
	JC	1996 →		Z9Y	0.5		
	Jet	1996 →	OE064	RL82YC	0.5	8814	
	Mulan B	1996 →	OE064	RL82YC	0.5	8814	
	Mulan Super AG	1996 →	OE064	RL82YC	0.5	8814	
	Standard	1996 →	OE064	RL82YC	0.5	8814	

SIAM

50cc	Falkon	1997 →	OE086	RL82C	0.6	8814	
	Scros (I)		OE064	RL82YC	0.6	8814	
	Scross		OE064	RL82YC	0.7	8814	

SIAMOTO

25cc	Birdie Mofa	1999 →	OE064	RL82YC	0.6	8814	
50cc	Birdie Mokick	1999 →	OE064	RL82YC	0.6	8814	
	Sross	1999 →	OE086	RL82C	0.5	8814	
125cc	Capri	1999 →		Z9Y	0.7		
	Favourite	1999 →		Z9Y	0.7		
	KD	1999 →		Z9Y	0.7		

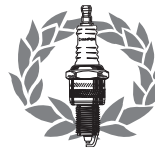
**21****POWER
SPORT****SIMSON**

50cc	City 2000	1995 →	L78C	0.6	8883	
	SR	1985 →1990	L82C	0.5	8814	
	SR CC, CCE	1993 →	L82C	0.5	8814	
	SR XC, XCE, XG	1985 →1990	L82C	0.5	8814	
	SR, 1B, C, CE	1990 →	L82C	0.5	8814	
	Star	1996 →	L82C	0.5	8814	
	Star 25 Basic	1996 →	RL87YC	0.6		
	Star Classic / Hot Summer	1996 →	RL87YC	0.5		
80cc	Hot Summer	1996 →	L82C	0.5	8814	
	SR 80 /1B		L78C	0.6	8883	
	SR 80 /1XCE		L78C	0.6	8883	
	Star Classic	1996 →	L82C	0.5	8814	

SOLO

50cc	Moped 713		OE086 RL82C	0.5	8814	
	Moped 723		OE086 RL82C	0.5	8814	

STEFFEN

50cc	Steffi	1998 →	OE007 L87YC	0.6		
	Steffi S	1998 →	OE007 L87YC	0.6		

SUNDIRO

50cc	Speedy	1996 →	OE040 N2C	0.5	8904	
80cc	Speedy	1995 →	OE040 N2C	0.5	8904	
125cc	Phoenix XDZ TA, T	1996 →	Z9Y	0.5		

SUZUKI

50cc	AH Address (AG50G)		RL87YC	0.5		PRO-5M
	AH Address Roller (CA1GA)		OE064 RL82YC	0.8	8814	PRO-5M
	AJ (CA1GA)	1995 →	OE064 RL82YC	0.6	8814	PRO-5M
	AJ ZZ (CA1GA)	1995 →	OE064 RL82YC	0.6	8814	PRO-5M
	AP (CA1JA)	1995 →	OE064 RL82YC	0.8	8814	PRO-5M
	AP Roller		RL87YC	0.5		PRO-5M
	AY		RL87YC	0.6		PRO-5M
	AY W		RL87YC	0.6		PRO-5M
	CP (CA14C)		OE064 RL82YC	0.8	8814	PRO-5M
	CP F (CA14C)	1992 →	OE064 RL82YC	0.8	8814	PRO-5M
	CP H, J, L, M, N		OE064 RL82YC	0.8	8814	PRO-5M
	F Scooterette		OE037 L86C	0.6		
	UF Estilete	2000 →	OE064 RL82YC	0.7	8814	
	UX W Zillion	1999 →	RL86C	0.6		
100cc	Address AH		OE064 RL82YC	0.5	8814	PRO-5M
	Address AH Roller	1995 →	OE064 RL82YC	0.8	8814	PRO-5M
110cc	UG Hokuto	2000 →	OE064 RL82YC	0.7	8814	
125cc	AN S	1995 →	RG94C	0.7	8698	
	AN T	1996 →	RG96C	0.7	8698	
	AN V, W, X	1997 →	OE092 RG4HC	0.7	8698	
	CS D	1983 →	OE083 RA6HC	0.7	8809	
	UC Epicuro	1999 →	RG94C	0.7	8698	
	UE C	2001 →	RG96C	0.6	8698	
	UH	2002 →	RG94C	0.7	8698	
150cc	AN T	1996 →	RG96C	0.7	8698	
200cc	UH	2007 →	RG94C	0.7	8698	
250cc	AN Burgman	1998 →	OE092 RG4HC	0.7	8698	
400cc	AN Burgman	1999 →	RG96C	0.8	8698	
650cc	AN Burgman (Fuel Injection)	2002 →	OE092 RG4HC	0.7	8698	

**SUZUKI**

**21****POWER
SPORT**

SYM						
50cc	City Hopper (Air cooled)	2000 →	RL78C	0.5	8883	
	DD 50		RL78C	0.6	8883	
	Fancy	1996 →	RL78C	0.6	8883	
	Fiddle (Air cooled)	2000 →	RL78C	0.5	8883	
	Fiddle High Bar (Air cooled)	2000 →	RL78C	0.5	8883	
	Flash	1996 →	RL78C	0.6	8883	
	Free	1996 →	RL78C	0.6	8883	
	Jet (Air cooled)	2000 →	OE064 RL82YC		8814	
	Jungle (Air cooled)	2000 →	RL78C	0.5	8883	
	Mask 50		RL78C	0.6	8883	
	Mio 50	2005 →	P-RZ9HC	0.7		
	Pure 50	1996 →	RL78C	0.6	8883	
	Red Devil (Air cooled)	2000 →	RL78C		8883	
	RS 50	2005 →	RL78C	0.6	8883	
	Shark 50		RL78C	0.6	8883	
	Super Fancy	1999 →	RL78C	0.6	8883	
100cc	Jet (Air cooled)	2000 →	RL78C		8883	
125cc	Euro MX 125 4V	2005 →	RG94C	0.7	8698	
	GTS 125	2006 →	RG94C	0.7	8698	
	HD		RG94C		8698	
	Joyride		RG94C		8698	
	Megalo 125		Z9Y	0.7		
	RS 125 4V	2005 →	RG94C	0.7	8698	
	Shark 4V	1999 →	P-RA7HC	0.7	8812	
	Shark 4VR	1999 →	P-RA7HC	0.7	8812	
200cc	HD		RG94C		8698	
	Joyride		RG94C		8698	
250cc	GTS 250	2006 →	RG94C	0.7	8698	
500cc	GT	2004 →	RG6YC	0.6		
	XP	2004 →	RG6YC	0.6		
TGB						
49cc	Arkos Taiwan Golden Bee- Bimota imports	→1995	OE007 L87YC	0.5		
	Ergon Taiwan Golden Bee- Bimota imports	→1995	OE007 L87YC	0.5		
50cc	Bunny AS 50 X		OE007 L87YC	0.6		
	KBX 50		OE007 L87YC	0.6		
TGM						
50cc	Akros 50		OE038 L82YC	0.7	8814	
	Ergon 50		OE038 L82YC	0.7	8814	
TOKAIDO						
25cc	RC		OE037 L86C	0.8		
50cc	2000 K50	1996 →	OE086 RL82C	0.6	8814	
	50 V		OE007 L87YC	0.6		
	SM 50		OE007 L87YC	0.6		
	SM 50/1		OE007 L87YC	0.6		
TWIST-N-GO						
49cc	All Models		QL78C	0.7	8883	
VELOCIFERO						
50cc	Velocifero 50 (I)		L78C	0.6	8883	

**21****POWER SPORT****VILLA BS**

50cc	Giorno			RL78C	0.6	8883	
	GP Dio		OE064	RL82YC	0.6	8814	
	SP Dio		OE064	RL82YC	0.6	8814	
	Z5			RL78C	0.6	8883	
	ZX			RL78C	0.6	8883	

VIVA

50cc	Viva	1996 →	OE007	L87YC	0.5		
-------------	------	--------	--------------	-------	-----	--	--

VIZA

33cc	Venom			RCJ8	0.8		
	Venture			RCJ8	0.8		

WINKING

50cc	Bunny AS ,X		OE007	L87YC	0.6		
	Bunny AS, AT, AX		OE038	L82YC	0.6	8814	
	Koala LM		OE037	L86C	0.6		
	Koala Scooter 2		OE037	L86C	0.6		
	Scooty		OE037	L86C	0.6		

WP

50cc	Wave 50	1996 →	OE064	RL82YC	0.5	8814	
-------------	---------	--------	--------------	--------	-----	------	--

YAMAHA

50cc	Aerox L.C.	1997 →		QL77JC4		8883	PRO-5M
	Axis	1996 →	OE086	RL82C	0.5	8814	PRO-5M
	Beluga CH50		OE064	RL82YC	0.5	8814	
	Breeze 50 Roller (4RC)	1993 →	OE086	RL82C	0.6	8814	PRO-5M
	Breeze YM50	1995 →		QL78C	0.6	8883	PRO-5M
	BW R Roller (4BX)	1991 →	OE086	RL82C	0.6	8814	PRO-5M
	BWS 50 NG (4VA)	1995 →		QL78C	0.6	8883	
	BWS CW50	1995 →	OE086	RL82C	0.6	8814	
	BWS CW50		OE086	RL82C	0.6	8814	
	BWS CW50	1996 →		QL78C	0.5	8883	
	BWS CW50RS NG	1996 →		QL78C	0.5	8883	
	BWS Original CW50	1995 →		QL78C	0.5	8883	
	BWS Road CW50R (Air cooled)	2000 →	OE064	RL82YC	0.5	8814	
	BWS Road CW50R	1995 →	OE086	RL82C	0.6	8814	
	BWS SPY (4VA)	1995 →		QL78C	0.6	8883	
	CR Z, SS	1992 →	OE064	RL82YC	0.8	8814	PRO-5M
	CT S	1992 →	OE064	RL82YC	0.8	8814	PRO-5M
	CW	1994 →		QL78C	0.5	8883	PRO-5M
	CW Bi-Wizz (4BX)	1991 → 1993	OE086	RL82C	0.6	8814	PRO-5M
	CW RS, RSP, RSX (4BX)	1994 →	OE064	RL82YC	0.8	8814	PRO-5M
	Evalis (YE50)(4FW)			RL78C	0.7	8883	PRO-5M
	EW Slider (Air cooled)	2000 →		QL77JC4		8883	
	Forte (YA50R) (3UG)			RL78C	0.7	8883	PRO-5M
	Jog R / RR	1994 →	OE064	RL82YC	0.8	8814	PRO-5M
	Jog-Z 50 (I)	1995 →	OE007	L87YC	0.7		PRO-5M
	Neos	1996 →	OE086	RL82C	0.5	8814	PRO-5M
	Slider (SA09)	2000 →		RL78C	0.6	8883	
	Spy 50 (I)			RL78C	0.6	8883	PRO-5M
	Why (SA03)	1999 →		RL78C	0.6	8883	
	YA R (5AK)	1996 →	OE086	RL82C	0.6	8814	PRO-5M
	YA R Axis (3UG)	1995 →	OE086	RL82C	0.6	8814	PRO-5M
	YH Why (Air cooled)	1999 →		QL77JC4		8883	
	YN Neos (Air cooled)	1997 →		QL78C	0.6	8883	
	Zest YE50	1995 →		QL78C	0.5	8883	PRO-5M

**YAMAHA**

**21****POWER SPORT****...YAMAHA**

80cc	Beluga CH80		OE086	RL82C	0.6	8814	PRO-5M
	Evolis (4MU)		OE086	RL82C	0.7	8814	PRO-5M
	YE C Roller Zest (4MU)	1992 →	OE086	RL82C	0.6	8814	PRO-5M
	YE Roller Zest (4NU)	1994 →	OE086	RL82C	0.6	8814	PRO-5M
	Zest (4MU)(YE80)		OE086	RL82C	0.7	8814	PRO-5M
100cc	Aerox 100	2001 →		RL78C	0.6	8883	
	BW 100 (SB02)	2000 →	OE086	RL82C	0.7	8814	
	BW 100 (SB02)	1999 →2000		RL78C	0.6	8883	
	Neos 100 (SB04)	2000 →		RL78C	0.6	8883	
	YN Neos (Air cooled)	2000 →	OE108	RN3C	0.7	8904	
	YQ Aerox (Air cooled)	2000 →	OE108	RN3C	0.7	8904	
125cc	Beluga BL, C Beluga Roller (50W/51F)	1984 →1989	OE064	RL82YC	0.8	8814	PRO-5M
	Beluga XC125	1997 →		Z9Y	0.5		PRO-5M
	Doodo (SE041)	2001 →		RG94C	0.7	8698	
	Majesty 125 (I)		OE083	RA6HC	0.6	8809	
	Maxster XQ	2001 →		RG94C		8698	
	Teo's	2001 →		RG94C		8698	
	XCE	1993 →		P-RZ9HC	0.7		
	XC E, SC Beluga Roller (3TE)	1990 →		P-RZ9HC	0.7		
	XC F Roller (3TE)	1994 →		P-RZ9HC	0.7		
	XC N, NC, U, W			P-RZ9HC	0.7		
	XC S, SC, ZS, ZSC			P-RZ9HC	0.7		
	XCT Beluga (4TH/4UT)	1994 →		RG96C	0.7	8698	
	XCT Cygnus Roller (4NB)	1994 →		P-RZ9HC	0.7		
	XC X, W, ZW			P-RZ9HC	0.7		
	XN Teo's (Liquid cooled)	2000 →		RG94C	0.7	8698	
	XQ Maxster (Liquid cooled)	2000 →		RG94C	0.7	8698	
	YP 125 R X-MAX	2006 →	OE092	RG4HC		8698	
	YP Majesty (Liquid cooled)	1998 →	OE083	RA6HC	0.9	8809	
150cc	XC 150 Fly one (I)	1995 →		RG96C	0.7	8698	
152cc	Majesty	2001 →		RG94C		8698	
	Maxster	2001 →		RG94C		8698	
250cc	X-City	2007 →	OE083	RA6HC	0.9	8809	
	YP Grand Majesty	2004 →		RG6YC	0.9		
	YP Majesty / X-Max (Liquid cooled) (4UC)	1995 →	OE083	RA6HC	0.7	8809	
300cc	VP 300 Versity	2003 →	OE083	RA6HC	0.6	8809	
500cc	XP TMAX (Liquid cooled)	2000 →		RG96C	0.7	8698	

ZONGSHEN

50cc	GY50			Z9Y			
	Happer		OE092	RG4HC	0.7	8698	
	Vento Phantom 2Stroke		OE007	L87YC	0.5		
	Vento Triton 2Stroke		OE007	L87YC	0.5		
	Vento Zip 2Stroke		OE007	L87YC	0.5		
100cc	Happer		OE092	RG4HC	0.7	8698	
110cc	C110			Z9Y			
125cc	Leader			RG6YC	0.7		
	CBT			Z9Y			
	GY6			Z9Y			

**21****POWER SPORT****ACCESS**

50cc	Long 50		RL78C	0.8	8883
	Streak 50		RL78C	0.8	8883

100cc	Long 100		RL78C	0.8	8883
-------	----------	--	-------	-----	------

ACTION

	Buddy	1996 → 1998	RL86C	0.7	
--	-------	-------------	-------	-----	--

ADLY

50cc	ATV 50		OE007 L87YC	0.6	
125cc	Buggy 125		RZ96C	0.8	

ADVENTURER

100cc	HM	1977 → 1980	RJ8C	0.7	
-------	----	-------------	------	-----	--

AEON

50cc	Cobra	2003 →	OE064 RL82YC	0.8	8814
	Minikolt	2003 →	OE064 RL82YC	0.8	8814
	Revo	2004 →	OE064 RL82YC	0.8	8814
100cc	Cobra	2002 →	OE064 RL82YC	0.8	8814
	Revo	2004 →	OE064 RL82YC	0.8	8814
125cc	Cobra RS 1		RZ96C	0.8	
	Cobra RS 2		RZ96C	0.8	
	Cobra Sport	2002 →	RZ94C	0.8	
	Cobra Utility	2002 →	RZ96C	0.8	
	Overland	2004 →	RZ96C	0.8	
180cc	Cobra RS 1		RZ96C	0.8	
	Cobra RS 2	2004 →	RZ96C	0.8	
	Cobra RS 2		RZ96C	0.8	
	Cobra Sport	2002 →	RZ94C	0.8	
	LG 180	2005 →	RZ96C	0.8	
	Overland	2004 →	RZ96C	0.8	
	Overland II	2005 →	RZ96C	0.8	
	Utility	2002 →	RZ96C	0.8	
220cc	Cobra 220	2005 →	RZ96C	0.6	

ALSPORT

171cc	Hirth		QL78C	0.8	8883
395cc	JLO		D9	0.8	
400cc	CCW		QL78C	0.8	8883
440cc	JLO		D9	0.8	
634cc	Hirth		QL78C	0.8	8883

ALSPORT-STEEN

80cc	All Models		J4C	0.7	
100cc	All Models		J4C	0.7	

AMERICAN CONTINENTAS

	ACG-300, ACG-4000		RJ8C	0.8	
--	-------------------	--	------	-----	--

AMERICAN PRIDE

	B&S 9 h.p. Vanguard		RC14YC	0.8	8071
--	---------------------	--	--------	-----	------

AMPHICAT

225cc	CCW		D9	0.8	
280cc	Sachs		D9	0.8	
290cc	Sachs		D9	0.8	
	B&S 8 h.p.		RJ19LM	0.8	

ARCO E-Z RIDER

	3-Z Three-Wheeler		RJ8C	0.8	
	Mini-Bikes		RJ8C	0.8	



**21****POWER SPORT****ARCTIC CAT**

90cc	Quad	2002 →	OE064	RL82YC	0.6	8814
246cc	Quad	1999 →		P-RA7HC	0.7	8812
250cc	250 2x4, 4x4 Quad	1999 → 2005		P-RA7HC	0.6	8812
	250 DVX Sport-Quad	2005 →		P-RA7HC	0.6	8812
300cc	300 2x4, 4x4 Quad	1999 → 2005		P-RA7HC	0.6	8812
	Quad	1999 →		P-RA7HC	0.7	8812
400cc	400 2x4 Quad	1998 → 2003		RG94C	0.6	8698
	400 2x4 Quad	2004 →		RG94C	0.6	8698
	400 4x4 Quad	1998 → 2003		RG94C	0.6	8698
	400 4x4 Quad	2004 →		RG94C	0.6	8698
	400 4x4 Autom. Quad	2005 →		RG94C	0.6	8698
	400 TBX Quad	2004 →		RG94C	0.6	8698
	400i 4x4 Sport Quad	2004 →		RG94C	0.6	8698
454cc	2x4	1996 → 1997		RG94C	0.7	8698
	Bearcat 4x4	1996 → 1997		RG94C	0.7	8698
500cc	500 2x4 Autom. Quad	2004 →		RG96C	0.6	8698
	500 4x4	1999 → 2002		RG96C	0.6	8698
	500 4x4 Autom. Quad	2003 → 2004		RG96C	0.6	8698
	500 TBX 4x4 Quad	2005 →		RG96C	0.6	8698
	500 TRV 4x4 Quad	2005 →		RG96C	0.6	8698
	500i A 4x4 Quad	2006 →		RG96C	0.6	8698
650cc	650 V2 4x4 Quad	2005 →		RG94C	0.6	8698
	650 V2 4x4 Quad	2006 →		RG94C	0.6	8698
	650 H1 4x4 Quad	2006 →		RG96C	0.6	8698
	Chrysler 82019			RL86C	0.7	
	SSS Cat II			RJ8C	0.7	
	SSS Cat Sachs			RL86C	0.7	

ARGO

399cc	6 & 8 w/Kohler Eng. (18mm)	1974 →		D6	0.8	
440cc	6 & 8 w/Kohler Eng. (18mm)	1974 →		D9	0.8	
480cc	Vanguard 2 6x6		OE013	RC12YC	0.6	8071
	Vanguard 6x6		OE013	RC12YC	0.6	8071
570cc	Bigfoot 6x6		OE013	RC12YC	0.6	8071
	Response 8x8		OE013	RC12YC	0.6	8071
614cc	Conquest 6x6		OE013	RC12YC	0.6	8071
617cc	Conquest 8x8			RCJ8	0.6	
674cc	Avenger 8x8			RCJ8	0.6	
	6 & 8 w/B&S 16 h.p. (Twin)			RJ12C	0.8	
	6 & 8 w/B&S 16 h.p. (Twin)			RJ19LM	0.8	
	6 & 8 w/Kawasaki 20 h.p. (Liquid V-Twin)			CJ14	0.7	
	6 & 8 w/Kohler 17 & 18 h.p. (Twin)			RV17YC	0.7	
	6 & 8 w/Kohler Eng.	1974 → 1976	OE091	RN2C	0.8	8904
	6 & 8 w/Kohler Eng.	1977 → 1982	OE108	RN3C	0.8	8904
	6 & 8 w/Kohler Eng.			CJ14	0.7	
	6 & 8 w/Kohler Eng. 17 & 18 h.p. (Twin)	1983 → 1989		RV17YC	0.7	
	6 & 8 w/Tec. 16 h.p.		OE086	RL82C	0.8	8814
	6 & 8 w/Tec. 16 h.p. OHV		OE098	RN4C	0.8	8339

ASM

30cc				RJ8C	0.6	
50cc				RJ8C	0.6	
90cc				RL86C	0.6	
100cc				RL86C	0.6	

**21****POWER SPORT**

ATK						
50cc	Mini Quad	2001→	RL78C	0.6	8883	
90cc	Mini Quad	2001→	RL78C	0.6	8883	
ATTEX						
	L252 10 h.p. JLO Eng		D14	0.8		
	L295 21 h.p. JLO Eng		D9	0.8		
	LR399-2 30, 34 h.p. JLO Eng		OE108 RN3C	0.8	8904	
	LR440-2		OE091 RN2C	0.8	8904	
	w/Tec. Eng		RL86C	0.8		
	w/Xenoah Eng		OE091 RN2C	0.8	8904	
AVENGER						
	K181S	1980→1984	RCJ8	0.7		
BAJAJ						
145cc	RE 2S 3 wheel passenger carrier	2008→	OE059 L92YC			
173cc	RE 4S 3 wheel passenger carrier	2008→	OE059 L92YC			
	RE 4S CNG 3 wheel passenger carrier	2008→	OE059 L92YC			
	RE 4S LPG 3 wheel passenger carrier	2008→	OE059 L92YC			
	Tristar Autoriksha	1980→1984	RL86C	0.6		
	TriStar Pickup Truck	1980→1984	RL86C	0.6		
	TriStar Tractor Trailer	1980→1984	RL86C	0.6		
	TriStar, Autoriksha	→1985	RL86C	0.6		
BAROSSA MOTOR						
50cc	Mini		OE064 RL82YC	0.6	8814	
	Python		OE064 RL82YC	0.8	8814	
100cc	Python		OE064 RL82YC	0.8	8814	
150cc	Magna		OE083 RA6HC	0.7	8809	
170cc	Magna		OE083 RA6HC	0.7	8809	
250cc	Magna		OE083 RA6HC	0.7	8809	
BLANEY						
79cc	FX70	1999→	OE038 L82YC	0.7	8814	
90cc	FX90	2000→	OE038 L82YC	0.7	8814	
100cc	FX100	2000→	OE038 L82YC	0.7	8814	
BOMBARDIER						
50cc	50 DS	2002→	OE064 RL82YC	0.6	8814	
	50 Quest	2003→2003	OE064 RL82YC	0.8	8814	
	DS 50	2004→	OE091 RN2C	0.5	8904	
	Quest 50	2004→	OE091 RN2C	0.5	8904	
83cc	90 DS	2002→	OE064 RL82YC	0.6	8814	
90cc	90 DS 4stroke	2002→	RZ96C	0.7		
	90 Quest	2003→2003	RZ96C	0.7		
	DS 90	2004→	OE091 RN2C	0.5	8904	
	Quest 90	2004→	OE091 RN2C	0.5	8904	
175cc	175	2003→	RG94C	0.7	8698	
176cc	Rally 200	2004→	OE091 RN2C	0.5	8904	
200cc	Rally	2003→	RG94C	0.7	8698	
330cc	330	2002→	OE083 RA6HC	0.9	8809	
	Outlander	2004→	OE091 RN2C	0.5	8904	
400cc	Outlander	2003→	OE083 RA6HC	0.9	8809	
	Outlander	2004→	OE091 RN2C	0.5	8904	
498cc	Quest	2003→	OE091 RN2C	0.5	8904	
	Traxter	2003→	OE091 RN2C	0.5	8904	

**BOMBARDIER**

**21****POWER SPORT****...BOMBARDIER**

500cc	500	2002 →	OE083	RA6HC	0.9	8809
	500 Traxter 7401	1999 → 2002	OE083	RA6HC	0.7	8809
	500 Traxter 7414	1998 → 2002	OE083	RA6HC	0.7	8809
644cc	Quest 644	2003 →	OE091	RN2C	0.5	8904
650cc	650 Quest	2002 → 2003	OE083	RA6HC	0.9	8809
	650 Traxter DS / DR	2000 →	OE083	RA6HC	0.7	8809
653cc	650 DS 653	2003 →	OE091	RN2C	0.5	8904

BOSS

90cc	X2S1-90R		OE007	L87YC	0.6	
155cc	X4S2-150R		OE007	L87YC	0.6	

BRISTER

	Brister's Chuck Wagon 11.0 HP Honda OHV GX340		OE048	RN9YC4	1.1	8415
	F1-25 5 HP OHV Tecumseh			RN5C	0.6	8339
	F1-265, F1-265E 6.5 HP OHV Tecumseh			RN5C	0.6	8339
	F2-265, F2-265E 6.5 HP OHV Tecumseh			RN5C	0.6	8339
	The Bug 3 HP Tecumseh			RJ8C	0.6	
	The Scorpion 6.5 HP OHV Tecumseh			RN5C	0.6	8339
	The Scorpion S 6.5 HP OHV Tecumseh			RN5C	0.6	8339
	The Scorpion S 11.0 HP OHV Tecumseh			RN5C	0.6	8339
	The Spider 5 HP OHV Tecumseh			RN5C	0.6	8339
	The Spider X 6.5 HP OHV Tecumseh			RN5C	0.6	8339
	The Stinger 5 HP OHV Tecumseh			RN5C	0.6	8339

BUSH HOG

	Trail Hunter 16.0 hp B&S		OE013	RC12YC	0.7	8071
	Trail Hunter 20.0 hp Honda		OE004	RN9YCC	0.6	8415
	Trail Hunter 24.0 hp Honda		OE060	RN9LCC	0.6	

CANNONDALE

432cc	FX 400	2000 →	OE092	RG4HC	0.7	8698
440cc	Blaze	2002 →	OE092	RG4HC	0.7	8698
	Cannibal	2002 →	OE092	RG4HC	0.7	8698
	Glamis	2003 →	OE092	RG4HC	0.7	8698
	Moto	2002 →	OE092	RG4HC	0.7	8698
	Speed	2002 →	OE092	RG4HC	0.7	8698

CARTER

	3.5 HP B&S			RJ19LM	0.6	
	5.0 HP B&S			RJ19LM	0.6	
	5.0 HP TECUMSEH OHH50		OE001	N9YC	0.8	8415
	5.5 HP HONDA GX160		OE004	RN9YCC	0.8	8415
	6.0 HP TECUMSEH OHH60			RN5C	0.7	8339
	6.5 HP OHV Tecumseh			RN5C	0.6	8339
	6.5 HP Tecumseh OHH65		OE001	N9YC	0.8	8415
	8.0 HP B&S			RJ19LM	0.6	
	8.0 HP TECUMSEH			RJ17LM	0.6	
	8.0 HP TECUSEH			RJ8C	0.6	
	10.0 HP TECUMSEH			RJ17LM	0.6	
	SMC ENGINE			RZ96C	0.8	

CHRYSLER ENGINES

	61012, 82001, 82002		OE086	RL82C	0.8	8814
--	---------------------	--	--------------	-------	-----	-------------

COLUMBIA PAR CAR

	w/B&S 9 h.p. Vanguard		OE013	RC12YC	0.8	8071
--	-----------------------	--	--------------	--------	-----	-------------

COMMUTER

	w/Kawasaki Engs.	→1985		RL86C	0.8	
--	------------------	-------	--	-------	-----	--

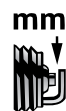
**21****POWER SPORT****COOT**

124SS, 444SS
 Crocodile
 Red Baron w/JLO 295 Engs.
 Searcher
 Snoopy

RJ8C 0.8
 RJ8C 0.8
 D9 0.8
 RJ8C 0.8
 RJ8C 0.8

CPI**50cc**

200
 Carb 50
 Dirt Demon

2003 →
 2003 →
 2002 →

OE098 RN4C 0.8
 RL78C 0.8
 RL78C 0.8

8339
 8883
 8883

100cc

Carb 100
 Dirt Demon

2003 →
 2002 →

RL78C 0.8
 RL78C 0.8

8883
 8883

250cc

XS 250

2006 →

RZ96C 0.8

CUB CADET

4x2 9.5 hp Kawasaki
 4x2 18.0 hp Honda V-Twin OHV
 6x4 20.0 hp Honda V-Twin OHV

OE045 RN11YCC 0.7
OE060 RN9LCC 0.7
OE060 RN9LCC 0.7

8405

CUSHMAN

14mm Heads (Exc. Trackster)
 18mm (Tapered Seat)
 18mm Heads (Gasket Seat)
 Hollister
 Hollister
 Trackster

1985 →
 →1984

RH10C 0.8
 RF11YC 0.8
 RD16 0.8
 RV15YC4 0.8
 RF14YC 0.8
 J4C 0.8

8018

DAREN**50cc**

50

2000 →

OE064 RL82YC 0.8

8814

100cc

100

2000 →

OE064 RL82YC 0.8

8814

125cc

125

2000 →

OE083 RA6HC 0.7

8809

150cc

150

2000 →

OE083 RA6HC 0.7

8809

DAZON**50cc**

Stinger 50

RZ96C 0.8

150cc

Raider Classic 150R
 Raider Max 150R

RZ96C 0.7
 RG94C 0.7

8698

175cc

Buggy 175
 Raider Max 175R

OE083 RA6HC 0.9
 RG94C 0.7

8809
 8698

250cc

Raider Max 250R

RG94C 0.7

8698

DERBI**170cc**

170

OE083 RA6HC 0.7

8809

250cc

250

RZ94C 0.7

DINLI**50cc**

Cobia DL-503
 Diamond Back DL601-50 2-Stroke
 Dino 2002 →
 Dino DL501-50 2-Stroke
 Helix 2004 →
 JP DL502-51 2-Stroke
 T-Rex 2003 →

2002 →
 2004 →
 2003 →

OE064 RL82YC 0.6
OE064 RL82YC 0.8
OE064 RL82YC 0.6
OE064 RL82YC 0.8
OE064 RL82YC 0.8
OE064 RL82YC 0.6
OE064 RL82YC 0.8

8814
 8814
 8814
 8814
 8814
 8814
 8814

90cc

Beast DL602-90 2-Stroke
 Diamond Back DL601-90 2-Stroke
 Helix DL603-90 2-Stroke

OE064 RL82YC 0.8
OE064 RL82YC 0.8
OE064 RL82YC 0.7

8814
 8814
 8814

**DINLI**

**21****POWER SPORT****...DINLI**

100cc	T-Rex 100		OE038	L82YC	0.6	8814	
150cc	Diablo	DL604-150 4-Stroke		Z9Y			
	Enforcer	DL605-150 4-Stroke		Z9Y			
	Helix	DL603-150 4-Stroke		Z9Y			

DRR

50cc	DRR 50	2004 →	OE007	L87YC	0.7		
90cc	DRR 90	2004 →	OE007	L87YC	0.7		
	DRR 90 GT	2004 →		Z9Y			

EAR RACING

510cc	Evolution 510		OE083	RA6HC	0.6	8809	
625cc	Explorer 625		OE083	RA6HC	0.6	8809	
950cc	Extreme 950			RG94C	0.7	8698	
992cc	Energia 992		OE083	RA6HC	0.6	8809	

E-ATV

510cc	Evolution		OE083	RA6HC	0.7	8809	
625cc	Explorer		OE073	RA4HC	0.6		
950cc	Extreme			RG94C	0.8	8698	
992cc	Energie		OE083	RA6HC	0.7	8809	

ERING

50cc	Tornado 50		OE038	L82YC	0.7	8814	
250cc	Bug Rider BR250 Dual Seat			P-RA7HC	0.9	8812	

E-TON

40cc	Viper Juior	2003 →		CJ7Y	0.6		
50cc	Viper	2002 →	OE064	RL82YC	0.6	8814	
90cc	Sierra Ranger	2003 →	OE064	RL82YC	0.8	8814	
	Viper	2002 →	OE064	RL82YC	0.8	8814	
150cc	Yukon	1999 →		Z9Y	0.6		

E-Z RIDER

	406X Mini bike			RJ8C	0.8		
	TC-357			RJ8C	0.8		

FOX

50cc	50	2000 →	OE064	RL82YC	0.8	8814	
	50 VR Sport	2001 →	OE064	RL82YC	0.8	8814	
90cc	90 MT	1999 →		RZ96C	0.8		
100cc	100	2000 →	OE064	RL82YC	0.8	8814	

FRONTIER-TML (Quadra)

	Quadra Aero			RCJ8	0.8		
--	-------------	--	--	------	-----	--	--

G+G

1130cc	QUAD not Twinspark	2003 →	OE026	RC8DMC			
---------------	--------------------	--------	--------------	--------	--	--	--

GAS GAS

300cc	300 Wild	2002 →	OE108	RN3C	0.6	8904	
450cc	450 Wild	2002 →		RG94C	0.7	8698	

GO-PED

	Power Scooter			RCJ6Y	0.8		
--	---------------	--	--	-------	-----	--	--

GRECAV

50cc	Amica Luna		OE040	N2C	0.5	8904	
	Amica Quattro		OE040	N2C	0.5	8904	

HERKULES

50cc	ATV 50 RS XXL	2005 →	OE064	RL82YC	0.8	8814	PRO-5M
	ATV 50 VG	2004 →	OE038	L82YC	0.7	8814	PRO-5M
	ATV 50 VS	2004 →	OE038	L82YC	0.7	8814	PRO-5M

**21****POWER SPORT****...HERKULES**

100cc	ATV 100 V	2004 →	OE064	RL82YC	0.8	8814	PRO-5M
150cc	ATV 150 S	2004 →		RG94C	0.7	8698	
	ATV 150 U	2004 →		RG94C	0.7	8698	
300cc	ATV 300 S	2004 →	OE083	RA6HC	0.7	8809	
	ATV 300 U	2004 →	OE083	RA6HC	0.7	8809	

HONCHO

K181S

→1984

RCJ8

0.7

HONDA

70cc	TRX	1986 →		RZ96C	0.7		
90cc	ATC	1973 →1981		RZ96C	0.7		
	TRX	1995 →		RZ96C	0.7		
	TRX	1993 →1994		P-RZ9HC	0.7		
125cc	ATC (L=19mm)	1982 →	OE083	RA6HC	0.7	8809	
	TRAX		OE083	RA6HC	0.7	8809	
	TRX	1985 →	OE083	RA6HC	0.7	8809	
185cc	ATC S-D		OE083	RA6HC	0.7	8809	
200cc	ATC Big Red	1982 →	OE083	RA6HC	0.7	8809	
	ATC E, X, ES/M/S	1982 →	OE083	RA6HC	0.7	8809	
	TRX D Fourtrax II	1986 →1990	OE083	RA6HC	0.7	8809	
	TRX SX Fourtrax I	1990 →	OE083	RA6HC	0.7	8809	
250cc	ATC ES, SX	1986 →	OE083	RA6HC	0.7	8809	
	ATC R	1986 →		RAX92C	0.8	8809	
	FL		OE098	RN4C	0.6	8339	
	TRAX		OE083	RA6HC	0.7	8809	
	TRX		OE091	RN2C	0.6	8904	
	TRX R	1987 →	OE083	RA6HC	0.8	8809	
	TRX X		OE083	RA6HC	0.7	8809	
300cc	TRX	1992 →	OE083	RA6HC	0.8	8809	
	TRX EX	1993 →	OE083	RA6HC	0.7	8809	
	TRX FW	1993 →	OE083	RA6HC	0.9	8809	
	TRX N	1992 →	OE083	RA6HC	0.9	8809	
350cc	ATC X		OE083	RA6HC	0.7	8809	
	FL R Odyssey	1984 →		RAX92C	0.8	8809	
	Fourtrax Rancher 4x4 ES	2000 →2004		RA8HC	0.9	8812	
	TRX	1986 →	OE083	RA6HC	0.7	8809	
400cc	ATC		OE073	RA4HC	0.6		
	TRX	1998 →		P-RA7HC		8812	
	TRX ESW Foreman 4x4	1995 →		P-RA7HC	0.9	8812	
433cc	Foreman Rubicon	2000 →2004		RA8HC	0.8	8812	
450cc	TRX	2005 →		P-RA7HC		8812	
500cc	TRX (Liquid Cooled)	2006 →	OE013	RC12YC	1.0	8071	
	TRX	2001 →		RA8HC	0.7	8812	
650cc	TRX	2004 →	OE013	RC12YC	1.0	8071	
HUSABERG							
400cc	Quad			G59C		8698	
HUSQVARNA							
450cc	QM	2005 →		RG94C	0.6	8698	
HUSTLER							
	880			QL78C	0.7	8883	
	900		OE108	RN3C	0.8	8904	
	940-45			RH10C	0.8		
	Hustler	1969 →1970		D9	0.8		
	Tricart			RJ8C	0.8		

**HUSTLER**



21



**POWER
SPORT**



HYDRO TRAXX

w/Kohler 25 h.p. (V-Twin) 6 Wheeler

RC14YC

0.8

8071

HYOSUNG

50cc Quad TE, WOW

OE064 RL82YC

8814

90cc Quad TE, WOW

OE064 RL82YC

8814

JAWA

40cc Transistor

RH10C

0.8

JOHN DEERE

250cc Gator Kawasaki FE250D 8.0 hp

OE045 RN11YCC

0.7

8405

290cc Gator Kawasaki FE290D 9.5 hp

OE045 RN11YCC

0.7

8405

500cc Buck

OE083 RA6HC

0.7

8809

Trail Buck

OE083 RA6HC

0.9

8809

650cc Trail Buck

OE083 RA6HC

0.9

8809

Gator Kawasaki 10.0 hp

OE037 L86C

0.6

Gator Kawasaki FD620D 20.0 hp

CJ14

0.9

Gator Kawasaki OHV 18.0 hp

RCJ8

0.6

Gator 4x2

OE004 RN9YCC

0.8

8415

Gator 6x4

CJ14

0.9

KARCHER

170cc KM 170-8

OE083 RA6HC

0.7

8809

250cc KM 250-10

RZ94C

0.7

KM 250-11

RZ94C

0.7

KM 250-9

RZ94C

0.7

KASEA

50cc 2-Stroke

RL95YC

0.8

KAWASAKI

50cc KFX

2005→

RL95YC

0.6

KSF

2005→

RL95YC

0.6

80cc KDX

OE108 RN3C

0.6

8904

PRO-5M

KFX

2005→

RL95YC

0.6

KSF

2005→

RL95YC

0.6

110cc KLF A, B

OE108 RN3C

0.6

8904

KLT

Z9Y

0.6

160cc KLT

→1985

P-RA7HC

0.6

8812

KLT

Z9Y

0.6

185cc KLF

1986→

RAX92C

0.9

8809

KLT

1986→

RAX92C

0.9

8809

KLT

→1987

OE108 RN3C

0.6

8904

200cc KDX H, R, SR

OE108 RN3C

0.6

8904

KLT

OE098 RN4C

0.6

8339

220cc KLF Bayou (Light load)

1988→

OE083 RA6HC

0.8

8809

KLF Bayou

1988→

RAX92C

0.9

8809

250cc KDX

OE108 RN3C

0.6

8904

PRO-5M

KLF

2002→

RAX92C

0.7

8809

300cc KEF Lakota

1995→

OE083 RA6HC

0.8

8809

KLF Bayou 2x4

1988→

OE108 RN3C

0.6

8904

PRO-5M

KLF Bayou 4x4

1988→

OE083 RA6HC

0.8

8809

PRO-5M

KVF

1999→2002

OE083 RA6HC

0.7

8809

Lakota

1995→

OE083 RA6HC

0.8

8809

360cc KVF

2002→

OE083 RA6HC

0.9

8809

HYDRO TRAXX

**21****POWER SPORT****...KAWASAKI**

400cc	KFX	2003 →		RG96C	0.8	8698	
	KFX A	2003 →		RG94C	0.7	8698	
	KLF B	1993 → 1999	OE083	RA6HC	0.9	8809	
	KSF	2003 →		RG94C	0.7	8698	
	KVF A1	1994 →	OE083	RA6HC	0.8	8809	
	KVF C, D	1999 → 2002	OE083	RA6HC	0.9	8809	
	KXF A	2003 →		RG94C	0.6	8698	
450cc	KAF 450B / Mule 1000	1990 → 1995		RA8HC	0.7	8812	
520cc	Mule	2001 → 2003	OE004	RN9YCC	0.6	8415	
540cc	KAF 540C / Mule 2010	1990 → 1993	OE004	RN9YCC	0.6	8415	
620cc	KAF 620A+C / Mule 2510	1993 → 2002		CJ14	0.6		
	KAF 620E+G / Mule 3010	2001 →		RN14YC	0.6		
650cc	KVF 4x4	2005 →		RG96C	0.8	8698	
	KVF A	2000 →		RG96C	0.8	8698	
700cc	KFV	2004 →		RG96C	0.8	8698	
	KFX	2004 →		RG96C	0.8	8698	
	KSV	2004 →		RG96C	0.8	8698	
	KVF	2004 →		RG96C	0.8	8698	
750cc	KVF	2005 →		RG96C	0.8	8698	
KEEWAY							
50cc	ATV			RL78C		8883	
KOLPIN							
50cc	50			RL78C	0.8	8883	
90cc	90			RL78C	0.8	8883	
KREIDLER							
50cc	Mini Mustang	2005 →	OE064	RL82YC	0.8	8814	
	Mustang	2005 →	OE064	RL82YC	0.8	8814	
80cc	Mustang		OE086	RL82C	0.4	8814	
125cc	Mustang		OE083	RA6HC	0.7	8809	
	Mustang	1997 →		RZ96C	0.5		
	Mustang		OE083	RA6HC	0.7	8809	
170cc	Mustang 170	2005 →	OE083	RA6HC	0.7	8809	
	Mustang 200	2005 →	OE083	RA6HC	0.7	8809	
250cc	Mustang 250	2005 →		RZ94C	0.7		
KYMCO							
50cc	MX 50	2001 →		RL78C	0.5	8883	
	MXér 50	2005 →		RL78C	0.5	8883	
150cc	MX 150	2001 →	OE083	RA6HC	0.7	8809	
250cc	KXR 250	2001 →		P-RA7HC	0.9	8812	
	MXU 250	2005 →		P-RA7HC	0.9	8812	
300cc	Maxxer 300	2005 →		P-RA7HC	0.9	8812	
500cc	MXU 500 4x4	2006 →		RG94C	0.6	8698	
LEM							
50cc	Cayman	1997 → 2004		RL78C	0.6	8883	
	Condor	1997 → 2004		RL78C	0.6	8883	
LIL INDIAN							
	Outlaw Mini Bike			RJ8C	0.8		
LINHAI							
260cc	260	2005 →	OE083	RA6HC	0.7	8809	
LITTLE DAVID							
	Tri-Rod 3-Wheeler			RCJ8	0.8		

**LITTLE DAVID**

**21****POWER
SPORT**

MANCO						
50cc	Miny Indy 5.0 hp Subaru Engine		RL86C	0.7		
	Stock Car 4.0 hp Subaru Engine		RL86C	0.7		
	ZSR-50		OE064	RL82YC	0.8	8814
90cc	ZSR-90		OE064	RL82YC	0.8	8814
169cc	EZ Rider 6.5 hp Subaru Engine		RL86C	0.7		
260cc	8260E		OE083	RA6HC	0.7	8809
404cc	XTK-713E 13.5 hp Robin Subaru Engine		RL86C	0.6		
450cc	618 Super Deuce 18.0 hp Honda V-Twin OHV		OE045	RN11YCC	0.7	8405
MAX						
297cc	w/JLO 297 Engs.		D9	0.8		
340cc	Big Max w/JLO 340 Engs.		OE108	RN3C	0.8	8904
399cc	Big Max w/JLO 399 Engs.		OE108	RN3C	0.8	8904
440cc	Big Max w/JLO 440 Engs.		OE108	RN3C	0.8	8904
cc	Rim (4-cycle)		RL86C	0.8		
MIDWEST						
50cc	Bobcat 50		RL86C	0.8		
125cc	Tiger 125		OE083	RA6HC	0.8	8809
MINI BRUTE						
	w/Chry. 820 Engs.		RL86C	0.8		
	w/Solo 206 or 209 Engs.		OE086	RL82C	0.8	8814
MOTOR TEK						
50cc	MT 50	2005 →	RL78C	0.5		8883
125cc	MT 125	2005 →	RZ96C	0.8		
175cc	MT 175	2005 →	OE083	RA6HC	0.7	8809
MSA						
50cc	Fox	2000 →	RL78C	0.8		8883
	Mini Fox	2000 →	CJ8	0.6		
	Sport	2000 →	RL78C	0.8		8883
90cc	Fox	2000 →	RZ96C	0.6		
100cc	Fox	2000 →	RL78C	0.8		8883
	Sport	2000 →	RL78C	0.8		8883
MULAN						
50cc	QM50QW, QM50QW-A		RL95YC	0.7		
MZ						
50cc	ATV 50	2003 →	OE007	L87YC	0.6	
100cc	ATV 100	2003 →	OE007	L87YC	0.6	
125cc	MT 125 Cobra	2005 →	Z9Y	0.6		
150cc	KX 150	2005 →	RG96C	0.6		8698
	VRS 150	2005 →	RG96C	0.6		8698
PANDA						
50cc	KD A	2000 →2001	P-RZ9HC	0.7		
80cc	KD A	2000 →2001	P-RZ9HC	0.7		
125cc	KD A	2000 →2001	P-RZ9HC	0.7		
PGO						
110cc	110	2003 →	OE064	RL82YC	0.8	8814
150cc	151	2003 →		RZ96C	0.6	

**21****POWER
SPORT**

POLARIS							
50cc	Predator AR03-01	2003 →	OE064	RL82YC	0.8	8814	
	Scrambler	2001 →		RL87YC	0.7		
	Youth Scrambler AR03	2001 → 2003	OE064	RL82YC	0.8	8814	
90cc	Scrambler	2001 →		RL87YC	0.7		
	Sportsman	2001 →		RL87YC	0.7		
	Youth Predator AR07	2003 →	OE064	RL82YC	0.8	8814	
	Youth Scrambler AR07	2001 → 2002	OE064	RL82YC	0.8	8814	
	Youth Sportsman AR07	2001 →	OE064	RL82YC	0.8	8814	
200cc	Phönix 200	2005 →		RZ96C	0.6		
250cc	Big Boss	1989 → 1993	OE108	RN3C	0.6	8904	
	Cyclone	1988 → 1989	OE108	RN3C	0.6	8904	
	Scrambler	1989 → 1993	OE108	RN3C	0.6	8904	
	Trail Blazer	1990 →	OE108	RN3C	0.6	8904	
	Trail Blazer EC25PF-09	1995 →	OE108	RN3C	0.6	8904	
	Trail Boss	1985 →	OE108	RN3C	0.6	8904	
	Trail Boss EC25PF-08	1995 →	OE108	RN3C	0.6	8904	
	Xplorer EC25	2000 → 2002	OE108	RN3C	0.5	8904	
283cc	Xplorer 300	1994 →	OE108	RN3C	0.6	8904	
	Xpress 300	1994 →	OE108	RN3C	0.6	8904	
300cc	300 2x4, 4x4	1994 →	OE108	RN3C	0.6	8904	
	Xplorer EC28	1994 → 2000	OE108	RN3C	0.5	8904	
	Xpress EC28	1994 → 2000	OE108	RN3C	0.5	8904	
325cc	Magnum Standard	1995 →	OE013	RC12YC	0.7	8071	
	Xpedition	2002 →	OE005	RC9YC	0.7		
330cc	ATP	1995 →	OE013	RC12YC	0.7	8071	
	Magnum 4x4	2005 →	OE043	RC7YC	0.6		
	Trail Boss	2005 →	OE043	RC7YC	0.6		
334cc	Sportsman 335	1999 →	OE043	RC7YC	0.6		
350cc	Big Boss	1993 →	OE108	RN3C	0.6	8904	
	Trail Boss	1990 → 1993	OE108	RN3C	0.6	8904	
	Trail Boss EC35	1990 → 1993	OE108	RN3C	0.5	8904	
379cc	Big Boss 400L (6X6)	1995 → 1997	OE108	RN3C	0.6	8904	
	Scrambler 400 (4X4)	1994 →	OE108	RN3C	0.6	8904	
	Sport 400	1998 →	OE108	RN3C	0.6	8904	
	Sport ATV	1995 → 1997	OE108	RN3C	0.6	8904	
	Sportsman 4x4	1994 → 1997	OE108	RN3C	0.6	8904	
	Xplorer 400/400L 4x4	1994 →	OE108	RN3C	0.6	8904	
	Xpress 400 L 2x4	1996 → 1997	OE108	RN3C	0.6	8904	
400cc	Big Boss EC38	1995 → 1998	OE108	RN3C	0.5	8904	
	Scrambler EC38	1994 → 2002	OE108	RN3C	0.5	8904	
	Scrambler EC38PLE-03	1995 →	OE108	RN3C	0.6	8904	
	Sport EC38	1995 → 1999	OE108	RN3C	0.5	8904	
	Sport EC38PLE-02	1995 →	OE108	RN3C	0.6	8904	
	Sportsman 4x4, 6x6	1995 →	OE108	RN3C	0.6	8904	
	Sportsman EC38	2003 →	OE013	RC12YC	0.6	8071	
	Sportsman EC38	1994 → 1997	OE108	RN3C	0.5	8904	
	Trail Blazer EC38	2003 →	OE108	RN3C	0.5	8904	
	Trail Boss	2005 →	OE043	RC7YC	0.6		
	Xplorer 2x4, 4x4	1995 →	OE108	RN3C	0.6	8904	
	Xplorer EC38	1994 → 2002	OE108	RN3C	0.5	8904	
	Xpress EC38	1996 → 1997	OE108	RN3C	0.5	8904	

**POLARIS**

**21****POWER SPORT****...POLARIS**

425cc	Magnum (2X4)	1995 →	OE013	RC12YC	0.6	8071
	Magnum (4X4)	1995 →	OE013	RC12YC	0.6	8071
	Magnum (6X6)	1996 →1997	OE013	RC12YC	0.6	8071
	Magnum EH42PLE-01 Light Service	1995 →	OE013	RC12YC	0.7	8071
	Magnum EH42PLE-01 Standard	1995 →	OE013	RC12YC	0.7	8071
	Ranger EH42	2002 →	OE013	RC12YC	0.6	8071
	Sportsman EH42	2001 →2004	OE013	RC12YC	0.6	8071
	Workman	1997 →	OE013	RC12YC	0.7	8071
	Xpedition EH42	2001 →2003	OE013	RC12YC	0.6	8071
	500cc	ATP 500	2005 →	OE043	RC7YC	0.6
Big Boss 500 (6X6)		1998 →	OE013	RC12YC	0.6	8071
Boss		1999 →2000	OE013	RC12YC		8071
Hauler Light Utility EH50		2002 →2003	OE013	RC12YC	0.6	8071
Magnum		1999 →	OE013	RC12YC	0.6	8071
Predator ES 50		2003 →	OE083	RA6HC	0.9	8809
Predator 500		2005 →	OE083	RA6HC	0.9	8809
Pro ATV EH50		2002 →2003	OE013	RC12YC	0.6	8071
Ranger		1999 →	OE013	RC12YC	0.6	8071
Scrambler		1998 →	OE013	RC12YC	0.6	8071
Sportsman		1996 →2004	OE013	RC12YC	0.6	8071
Sportsman 6x6		2005 →	OE043	RC7YC	0.6	
Sportsman EFI		2006 →		RC7PYCBX	0.7	
Task Force Utility EH50		2002 →2003	OE013	RC12YC	0.6	8071
Trail Boss		2001 →	OE013	RC12YC		8071
Trail Quad	2001 →	OE013	RC12YC		8071	
Xplorer 500	1997 →	OE013	RC12YC	0.6	8071	
600cc	Sportsman	2003 →		RC7PYCBX	0.7	
653cc	Ranger TM	2004 →	OE042	RN12YC	0.7	8405
700cc	Sportsman	2002 →		RC7PYCBX	0.7	
	Sportsman EFI	2006 →		RC7PYCBX	0.7	
800cc	Sportsman	2005 →	OE043	RC7YC	0.6	
	Sportsman EFI	2005 →		RC7PYCBX	0.7	
	UTV 2X4 24 PS		OE013	RC12YC	0.6	8071
	UTV 4X4 30 PS		OE013	RC12YC	0.6	8071
	UTV 6X6 30 PS		OE013	RC12YC	0.6	8071

POWER TRAC

ATV-6000 w/Kohler 25 h.p. (V-Twin)

→2002

OE013

RC12YC

1.1

8071

PRAIRIE BOBCAT

295cc	295cc			D6	0.8	
340cc	340cc		OE091	RN2C	0.8	8904
440cc	440AX			QN19V		
	440LC			QN19V		

RUPPSTER

Dune - Chry. 82023 Engs.

RL86C

0.8

Mini-Dune w/JLO 230 Engs.

D9

0.8

SACHS

50cc	4rock	2006 →	OE064	RL82YC	0.7	8814
	Little Devil		OE007	L87YC	0.6	
	T-Rex	2006 →	OE064	RL82YC	0.6	8814
100cc	Helix	2006 →	OE064	RL82YC	0.6	8814
	T-Rex	2006 →	OE064	RL82YC	0.6	8814
110cc	4rock	2006 →	OE064	RL82YC	0.7	8814



**21****POWER SPORT****...SACHS**

150cc	4rock	2006 →	Z9Y	0.7		
	Helix	2006 →	Z9Y	0.6		
250cc	4rock	2006 →	RZ94C	0.7		
	KM24 Wankel 1/2" Rch.		OE086 RL82C	0.8	8814	
	KM24 Wankel 3/4" Rch.		OE108 RN3C	0.8	8904	

SANDPIPER

Scooter

RJ8C 0.8

SCAMP

Mini-Bikes

RJ8C 0.8

SHANAHAN

Power Board

RCJ8Y 0.7

Power Scooter

RCJ8Y 0.7

SIERRA

Trail Boss

D6 0.8

SPD

Tricart - B&S 8 h.p.

RJ19LM 0.8

Tricart - JLO 230 Engs.

D9 0.8

Tricart - JLO 295 Engs.

D9 0.8

Tri-Cub - B&S 8 h.p.

RJ19LM 0.8

STAR QUAD**50cc** Jinlun JL50QT-5 Roller

Z9Y 0.7

STARCRAFT

All Models

D6 0.8

STREAKER

w/B&S 3.5, 5 & 11 h.p.

RJ19LM 0.8

w/B&S 9 h.p. Vanguard

RC14YC 0.8

w/Honda 5.5, 6, 6.5 & 13 h.p.

OE051 RN11YC 0.8

w/Tec. 10 h.p.

RJ19LM 0.8

w/Tec. 4 & 5 h.p.

RJ8C 0.8

w/Tec. 5, 6 & 13 h.p. OHV

OE098 RN4C 0.8**SUNDOWNER**

Mini-Bikes w/Sachs Engs.

RL86C 0.8

SUZUKI

50cc	LT 4x4		OE059 L92YC	0.6		PRO-5M
80cc	LT		OE064 RL82YC	0.8	8814	PRO-5M
160cc	LT E GB L,M,N	1990 →	P-RA7HC	0.9	8812	
	LT E K	→1989	P-RA7HC	0.7	8812	
	LT E L,M,N	1990 →	P-RA7HC	0.9	8812	
	LTF GB L,M,N,P,R,S,T	1990 →	P-RA7HC	0.9	8812	
	LTF L,M,N,P,R,S,T	1990 →	P-RA7HC	0.9	8812	
230cc	LT E H	1986 →1988	P-RA7HC	0.7	8812	
	LT E J,K	1988 →1990	P-RA7HC	0.7	8812	
	LT E L,M,N,P	1990 →	P-RA7HC	0.7	8812	
	LT GE F,G	1985 →	P-RA7HC	0.7	8812	
	LT GEF, S F,G	1985 →	P-RA7HC	0.7	8812	
	LT S H,J	1987 →	P-RA7HC	0.7	8812	
	LTF B,EU G,H	1986 →	P-RA7HC	0.7	8812	
	LTF GB G,H	1986 →	P-RA7HC	0.7	8812	



**21****POWER SPORT****...SUZUKI**

250cc	LT 4WD 4WD, F4WD		OE083	RA6HC	0.6	8809
	LT E, EF2, EFF, FE, F, G	1985 →	OE083	RA6HC	0.7	8809
	LT R, F, G, J, K	1985 → 1990	OE068	N3C	0.6	8904
	LT R, L, M, N	1990 →	OE040	N2C	0.6	8904
	LT S, K, L	1990 →		P-RA7HC	0.9	8812
	LT S GB, L	1989 →		P-RA7HC	0.9	8812
	LT F 4WD	1992 →	OE083	RA6HC	0.6	8809
	LT F, J, K, L	1988 → 1991		P-RA7HC	0.6	8812
	LT F, M, N, P, R, S, T	1991 →		P-RA7HC	0.6	8812
	LT F USA, J, K, L	1988 → 1991		P-RA7HC	0.6	8812
280cc	LT 4WD, J, K, L, M, N, P, R, S, T	1988 →		P-RA7HC	0.7	8812
	LT F 4WD, X, H, K, L, M, N, P, R, S, T	1987 →		P-RA7HC	0.7	8812
	LT F 4WD, X, M, N, P, R, S, T	1991 →		P-RA7HC	0.7	8812
300cc	LT E, H, J, K	1987 →	OE083	RA6HC	0.7	8809
	LT F, H, J, K	1987 →	OE083	RA6HC	0.7	8809
400cc	LT-A, F	2002 →		RG96C	0.6	8698
	LT-F, F	2002 →		RG96C	0.6	8698
	LT-Z	2002 →		RG96C	0.6	8698
500cc	LT R		OE108	RN3C	0.6	8904
	LT-A, F	2000 →		RG96C	0.6	8698
	LT-F	1998 → 2000		RG96C	0.6	8698
	LT-F, F	2000 →		RG96C	0.6	8698

SYM

200cc	Track Runner	2006 →		RG94C	0.6	8698
250cc	Quad Lander	2006 →		RG94C	0.6	8698

TANAKA

QBM-23	→ 1985			RCJ8	0.8	
QBM-23N, QBM-23NA	→ 1985			RCJ8	0.8	

TAURUS

1988-85 650 w/B&S 16 h.p. (Twin)				RJ19LM	0.8	
----------------------------------	--	--	--	--------	-----	--

TECUMSEH ENGINES

HH817LB				RJ17LM	0.8	
HMB25, HMB30				RJ8C	0.8	
HMB35, HSMB40				RJ8C	0.8	
HSMB50, HMB60				RJ8C	0.8	
HSSMB70, HSMB80				RJ8C	0.8	

TERRA-JET

453 w/B&S 18 h.p. (Twin)				RJ19LM	0.8	
453 w/Tec. 16 h.p.			OE086	RL82C	0.8	8814
VA6 w/B&S 18 h.p. (Twin)				RJ19LM	0.8	
VA6 w/Tec. 16 h.p.			OE086	RL82C	0.8	8814
VA6-18 w/B&S 18 h.p. (Twin)				RJ19LM	0.8	
VA6-18 w/Tec. 16 h.p.			OE086	RL82C	0.8	8814

TERRA-TIGER

w/JLO 252 or 295 Engs.				D9	0.8	
------------------------	--	--	--	----	-----	--

TERRATLAN

35cc	Mini Bike			RCJ8Y	0.8	
41cc	Mini Bike			RCJ8Y	0.8	

TNG

50cc	Venice 492		OE007	L87YC	0.7	
125cc	Del Ray			Z9Y	0.7	
	Milano			Z9Y	0.7	

**SUZUKI**

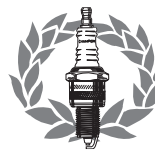
**21****POWER SPORT****...TNG**

150cc	Baja		Z9Y	0.6		
	Milano		Z9Y	0.7		

TOKOYA

50cc	Mini Bike		QL78C	0.7	8883	
80cc	Mini Bike		QL78C	0.7	8883	
125cc	Mini Bike		QL78C	0.7	8883	

TRACK AND SPORTS

w/Chry. 82021 Engs.

			RL86C	0.8		
--	--	--	-------	-----	--	--

TRACKSTER

w/OMC 437 Engs.

			J4C	0.8		
--	--	--	-----	-----	--	--

TRAILBLAZER

50cc	50		OE038 L82YC	0.7	8814	
	Mini		OE064 RL82YC	0.7	8814	
90cc	2-Stroke		OE038 L82YC	0.7	8814	
	4-Stroke		RZ96C	0.7		
170cc	170	2004 →	OE083 RA6HC	0.7	8809	
	Trailblazer 170		OE083 RA6HC	0.7	8809	
250cc	250		RZ94C	0.8		

TRAILSPORT

TS-500 5.0hp

TSB-600 6.0hp

		2004 →	RJ19LM	0.6		
		2004 →	RJ19LM	0.6		

TRI-SPORT

Baja Cub, Rover

Baja Scout, Nomad

Baja Sportsman, Blazer

w/B&S Engs.

w/Kohler Engs.

		1978 →	RCJ8	0.8		
		1978 →	RCJ8	0.8		
		1978 →	RCJ8	0.8		
		→1977	RJ19LM	0.8		
		→1977	OE091 RN2C	0.8	8904	

TSI POWERED SPORTS

Powerboard, Powerbike

Powerscooter, Dirtboard

			RCJ8Y	0.7		
			RCJ8Y	0.7		

UNILLI

150cc	KX 150	2005 →	RG96C	0.6	8698	
--------------	--------	--------	-------	-----	------	--

UNISOM

50cc	Desert-Cat 50	2004 →	RL78C	0.6	8883	
90cc	Desert-Cat 90	2004 →	RL78C	0.6	8883	

UNITED MOTORS

50cc	Dirt Squirt		RL78C	0.6	8883	
	Montrax		OE064 RL82YC	0.8	8814	
90cc	Dirt Squirt		RL78C	0.6	8883	
	Earthlander		OE064 RL82YC	0.8	8814	
	Moontrax		OE064 RL82YC	0.6	8814	
	Reptile		Z9Y	0.7		

VENTO

100cc	Avalanche EX100		OE064 RL82YC	0.7	8814	
250cc	Rhino 250		OE083 RA6HC	0.7	8809	

VINSON

150cc	ETV		Z9Y	0.6		
250cc	ETV		Z9Y	0.6		

WHIZZER

Motorbikes

			RJ19LM	0.7		
--	--	--	--------	-----	--	--

**WHIZZER**

**21****POWER SPORT****XING FU**

150cc	XF Trail 150	2005→	Z9Y	0.6		
250cc	XF Trail 250	2005→	Z9Y	0.6		

YAMAHA

50cc	YFM S	2004→	RZ96C	0.7		
60cc	YF N	1987→1988	OE007 L87YC	0.8		PRO-5M
80cc	YFM , W		RZ96C	0.6		
	YFM E, F	1993→	Z9Y	0.6		
125cc	YFA Breeze	1994→	RZ96C	0.7		
	YT CH, H, J, K, L/W		OE001 N9YC	0.8	8415	PRO-5M
175cc	YT J, K, L		OE010 N7YC	0.8	8332	PRO-5M
200cc	YFM	1985→1986	OE083 RA6HC	0.7	8809	
	YFM	1992→	OE132 A6HC	0.6	8809	
	YFS	1993→	OE108 RN3C	0.6	8904	PRO-5M
	YFS E, F		OE108 RN3C	0.6	8904	PRO-5M
225cc	TT T		OE083 RA6HC	0.7	8809	
	YFM		P-RA7HC	0.7	8812	
	YFM U, K, DXL, DRN, DXN, T	1992→	P-RA7HC	0.7	8812	
250cc	YFB E, F, FWF Timberwolf	1993→	P-RA7HC	0.7	8812	
	YFB FW Timberwolf	1994→	P-RA7HC	0.7	8812	
	YFM (3GH)	1990→	P-RA7HC	0.7	8812	
350cc	YFM 2HR, 2HN	1992→	OE083 RA6HC	0.7	8809	
	YFM ER, ERF, ERT, ERU, ERW	1994→	OE083 RA6HC	0.7	8809	
	YFM FWF, FWT, FWU, FWW, XF	1994→	OE083 RA6HC	0.7	8809	
	YFM FWX Wolverine	1992→	OE083 RA6HC	0.7	8809	
	YFM UT, XU, XW		OE083 RA6HC	0.7	8809	
	YFM X Warrior	1992→	OE083 RA6HC	0.7	8809	
	YFZ	1994→	OE108 RN3C	0.6	8904	
	YFZ E, F	1993→	OE108 RN3C	0.6	8904	
400cc	YFM FW	1994→	OE083 RA6HC	0.7	8809	
	YFM FWF	1994→	OE083 RA6HC	0.7	8809	
	YFM Kodiak	1993→	OE083 RA6HC	0.7	8809	
450cc	YFZ S	2004→	RG94C	0.7	8698	
660cc	YFM	2001→2004	OE083 RA6HC	0.9	8809	
	YXR	2004→	OE083 RA6HC	0.9	8809	
700cc	YFM	2005→	RG96C	0.9	8698	

YERF-DOG

90cc	23000	2004→	OE038 L82YC	0.7	8814	
150cc	23100	2004→	RN5C	0.6	8339	

ZONGSHEN

125cc	ZS125ST	2004→	OE013 RC12YC	0.6	8071	
--------------	---------	-------	---------------------	-----	------	--

**XING FU**

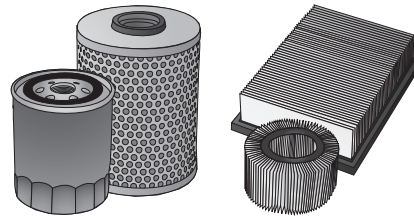

**NEW - NEU - NOUVEAU - NUOVO - NUEVO
NY - NIEUW - YENI - KAINOPYPIA - UUSI**



**C322
C325
F310
X347
X354
X355
X356
X357**



**J329
J331
J332
J333
J334
J335
J336
J337
J338
J339
J340
J341
J342
J343
J345
J346
U309**

**Y324
Y325
Y327
Y328
Y329
Y330
Y331
Y334
Y335
Y336
Y337
Y338
Y339
Y340
Y341
Y342**



kw

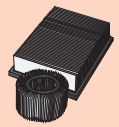
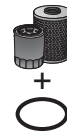
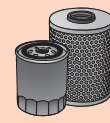

APRILIA

125cc	Atlantic	eng. LEADER		2003 →	C320		
	Leonardo			1996 → 2004	X325		Y318
	Mojito	, custom		2003 →	C320		
	Scarabeo	eng. ROTAX		1997 →	X325		
	Scarabeo	eng. LEADER		2003 →	C320		
150cc	Leonardo			1996 → 2004	X325		Y318
	Mojito	, custom		2003 →	C320		
	Scarabeo			1997 →	X325		
200cc	Atlantic	eng. LEADER		2003 →	C320		
	Scarabeo	eng. LEADER		2003 →	C320		
	Scarabeo	eng. ROTAX		2003 →	X325		
	Sportcity		13kW	2006 →	C320		
250cc	Scarabeo	eng. LEADER		2003 →	C320		
	Scarabeo	eng. ROTAX		2003 →	X325		
350cc	ETX		23kW	1986 → 1993	X305		
	Tuareg	Wind	23kW	1986 → 1993	X305		
500cc	Atlantic	, Sprint	29kW	2002 →	C316		
	Scarabeo			2002 →	C316		
600cc	Pegaso		36kW	1986 → 1993	X305		
	Tuareg	Wind	29kW	1987 → 1992	X305		
650cc	Moto 6.5		31kW	1994 →	X312		
	Pegaso			1997 →	X305		V300
	Pegaso	Factory	35kW	2007 →	X305		
660cc	Pegaso	Pegaso Street		2005 →	X302		V300
750cc	SL 750		70kW	2007 →	C316		
850cc	NA 850 Mana		55kW	2007 →	C316		
1000cc	ETV Caponord			2001 → 2004	X312		
	RSV	Mille, Factory, Nera		1998 → 2004	X312		
	R-Tuono	Factory, Racing		2004 → 2004	X312		
	R-Tuono	Factory, Racing		2005 →	TBA		
	SL	Falco	87kW	2000 → 2004	X312		
	SL Falcon			2000 → 2004	X312		

BENELLI

125cc	Adiva			2000 →	C320		
150cc	Adiva			2000 →	C320		
230cc	304		22kW	02/80 → 01/86	H302		
250cc	254	Sport		02/80 → 03/82	H302		
	Velvet Dusk 250		15kW	2000 → 2004	C320		
350cc	RS				X315		
	Sport 354			02/80 → 03/82	X315		
	Turismo 354				X315		
400cc	Velvet Dusk 400		23kW	2003 →	TBA		
500cc	504				X315		
	LS				X315		
	Sport 504				X315		
650cc	Sport 654			→ 1985	X315		
	T 654			→ 1985	X315		
750cc	Sei			→ 1982	X315		
900cc	Sei	N.L.		→ 1991	X315		
	Tornado TRE	ALL MODELS		2003 →	F310		
1130cc	Tornado	Tre/S	120kW	2007 →	F310		
	TNT	ALL MODELS		2004 →	F310		
	Trek		92kW	2007 →	F310		

APRILIA





kW

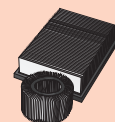
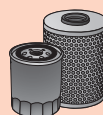

BETA							
250cc	RR250			2005 →	X320 (Short)		
	RR250			2005 →	X335 (Long)		
350cc	Alp-motard 4,0			2003 →	X319		
	Euro-Jonathan			2001 →	X319		
400cc	RR400			2005 →	X320 (Short)		
	RR400			2005 →	X335 (Long)		
450cc	RR450			2005 →	X320 (Short)		
	RR450			2005 →	X335 (Long)		
500cc	RR500			2005 →	X320 (Short)		
	RR500			2005 →	X335 (Long)		
BIMOTA							
600cc	YB 9	Sri (Yamaha mot. FZR 600)	78kW	1996 →	F301		
650cc	Supermono		35kW	1994 →	X305		
	Supermono	Biposto (BMW mot.)	35kW	1994 →	X305		
750cc	SB 7	(Suzuki mot. GSX)	97kW	1993 →	K301		
900cc	Mantra	(Ducati 900 mot.)	53kW	→ 1995	H301		
	DB 4 i.e.	(Ducati 900 mot.)	61kW	2000 → 2004	H301		
1000cc	YB 11	(Yamaha mot. FZR 1000)	107kW	1996 →	F301		
1100cc	SB 6	(Suzuki mot. GSX)	100kW	→ 1995	K301		
	SB 6	R (Suzuki mot.)	115kW	1996 →	K301		
BMW							
125cc	C1			2000 → 2003	X325		
200cc	C1			2002 → 2003	X325		
450cc	R 45			1976 → 1984	X317	X332	
500cc	R 50	/5		1969 → 1973	X317	X332	
600cc	R 60	,5, 6, 7		1969 → 1984	X317	X332	
650cc	F 650	FL,ST	25, 34, 35kW	1994 → 1998	X305		Y316
	F 650	CS	25, 37kW	2002 → 2005	X305		Y316
	F 650 (169)	GS/GS DAKAR	25, 37kW	1999 →	X305		U309
	G 650	Xchallenge	39kW	2007 →	X305		
	G 650	Xcountry	39kW	2007 →	X305		
	G 650	Xmoto	39kW	2007 →	X305		
	R 65	GS,US	20, 33, 35kW	1978 → 1988	X317	X332	
750cc	K 75	RT,S	55kW	1985 → 1988	C301	C312	
	R 75	,5, 6, 7		1969 → 1979	X317	X332	
800cc	R 80	GS, IN, R, RT, ST, 7	20, 25, 37kW	1982 → 1997	X317	X332	
	F 800	S, ST		2006 →	C325		
850cc	R 850	R, Comfort	25, 52kW	2002 →	C301		
	R	R, RT, GS	52kW	1995 →	C301	C312	V302
900cc	R 90	S/6		1973 → 1976	X317	X332	
990cc	K 100	Limited Edition,LT, RS	66, 74kW	1983 → 1994	C301	C312	
	K1		74kW	1989 → 1994	C301	C312	
	R 100	/7	44kW	1976 → 1978	X317	X332	
	R 100	CS	44kW	1980 → 1990	X316 (With oil cooler)	X333	
	R 100	CS	44kW	1980 → 1990	X317 (Without oil cooler)	X332	
	R 100	GS	44kW	1980 → 1995	X317 (Without oil cooler)	X332	
	R 100	GS	44kW	1980 → 1995	X316 (With oil cooler)	X333	
	R 100	GS Paris Dakar	44kW	1986 → 1995	X316 (With oil cooler)	X333	
	R 100	GS PD Classic	44kW	1995 → 1996	X317	X332	
	R 100	R	44kW	1992 → 1995	X316 (With oil cooler)	X333	
	R 100	R (Classic,Mystic)	44kW	1994 → 1996	X316	X333	
	R 100	RT	44kW	1978 → 1995	X316	X333	
	R 100	S, RS	44kW	1973 → 1986	X317 (Without oil cooler)	X332	
	R 100	S, RS	44kW	1973 → 1986	X316 (With oil cooler)	X333	

BMW



kW

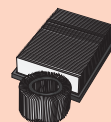
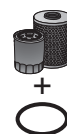
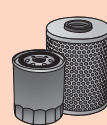

...BMW

1100cc	K 1100	LT, Special Edition, RS	74kW	1994 → 1998	C301	C312	
	R 1100	GS		1994 → 2000	C301	C313	V302
	R 1100	R, RS, RT		1994 → 2000	C301	C313	V302
	R 1100	S	72kW	2000 →	C301		
1150cc	R 1150 GS	Adventure		1999 → 2003	C301		V302
	R 1150 R	Rockster		2001 →	C301		V302
	R 1150 RS	,SE		2002 →	C301		V302
	R 1150 RT			2002 →	C301		V302
1200cc	HP2	ENDURO	77kW	2005 →	C325		
	HP2	MEGAMOTO	80kW	2007 →	C325		
	K 1200	RS, LT, GT	72kW	1997 →	C301		
	K 1200	GT (K44)		2005 →	C325		
	K 1200	R		2005 →	C325		
	K 1200	S (K40)		2005 →	C325		
	R 1200	C AVANTGARDE		1999 → 2005	C301	C313	
	R 1200	C CLASSIC		1999 → 2005	C301	C313	
	R 1200	C INDEPENDENT		2000 → 2005	C301	C313	
	R 1200	C MONTAUK		2002 → 2005	C301	C313	
	R 1200	CL (K30)		2001 → 2005	C301	C313	
	R 1200	GS/GS ADVENTURE (K25)		2004 →	C325		
	R 1200	R		2007 →	C325		
	R 1200	RT (K26)		2004 →	C325		
	R 1200	S		2006 →	C325		
	R 1200	ST (K28)		2005 →	C325		

BUELL

1000cc	XB9R		62kW	2000 →	C306/C314		
	XB9S		62kW	2000 →	C306/C314		
	XB9SX		62kW	2005 →	C306/C314		
1200cc	XB12S	Lighting	75kW	1998 →	C306/C314		
	XB12Ss	Lighting Long	75kW	2006 →	C306/C314		
	XB12R	Firebolt	75kW	1998 →	C306/C314		
	XB12X	Ulysses	75kW	2006 →	C306/C314		
	XB12S TT	Lightin Super TT	75kW	2007 →	TBA		
	M2 Cyclone		60kW	1997 → 1999	C306/C314		
	S3, T Thunderbolt		60kW	1997 → 1999	C306/C314		
	XB12Scg			2007 →	C306/C314		
	S1 Lightening		60kW	1997 → 1999	C306/C314		

CAGIVA

350cc	Ala	Azzurra 350			H301		
	W12			1994 → 1996	C302		
	Elefant	(Mot.Nr. 00767)			C302		
	Elefant	(Mot.Nr. 00768)			H301		
600cc	Canyon 600	,River		1996 → 1999	C302		
650cc	Ala	Azzurra (Ducati mot.)		1982 → 1988	H301		
	Elefant			1982 → 1988	H301		
	Raptor	,i.e., V		2000 →	K301		
750cc	Elefant		44kW	1989 →	H301		U302
900cc	Elefant	GT		1992 →	H301		U302
	Elefant	i.e.		1992 →	H301		U302
	Grand Canyon	900 i.e.	54kW	1997 → 2000	H301		U303
1000cc	Navigator			2000 →	K301		U303
	Raptor	, V, EXTRA		2000 →	K301		

C306 = Chromed filter

C314 = Black filter





kW

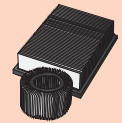
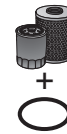
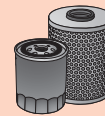

DAELIM							
125cc	VL 125	Daystar	9kW	1999 →	TBA		
	VL 125	Daystar Classic		2000 →	TBA		
	Roadwin 125			2005 →	TBA		
	VS 125	Advance, Evolution		1999 →	TBA		
	VT 125	Evolution		2000 →	TBA		
	Otello 125			2000 →	TBA		
	Freewing 125			2004 →	TBA		
	History 125			2000 →	TBA		
	NS 125 4T			2000 →	TBA		
DERBI							
125cc	Boulevard			2002 →	C320		
150cc	Boulevard			2002 →	C320		
200cc	Boulevard			2005 →	C320		
DUCATI							
350cc	Pantah				H301		
	Supersport	Junior			H301		U301
400cc	Monster			→ 2003	H301		U301
	Monster	IE		2004 →	H301		
	Supersport	Junior			H301		U301
	Supersport			1993 → 1997	H301		U301
500cc	Pantah	SL		1980 → 1984	H301		
550cc	Supermono		55kW	1993 →	H301		
583cc	Monster 600		39kW	1994 →	H301		U301
	Pantah 600			1980 → 1985	H301		
600cc	Monster	CROMO, DARK		1993 →	H301		U301
	Supersport			1991 → 1997	H301		U301
620cc	Monster	IE		2002 →	H301		
	SPORT			2003 →	H301		U301
650cc	Indiana			1986 → 1988	H301		U301
	Pandit	SL		1986 → 1988	H301		U301
748cc	748	BIPOSTO-SP, SPS, BIPOSTO, S, R, TESTA BASSA		1995 →	H301		
	748	RACING		1998 →	H301		
	749	S, R		2003 →	H301		
750cc	Biposto 748	SP		1995 → 2003	H301		
	F1			1984 → 1990	H301		
	GT	Sport		1972 → 1975	X331		
	Indiana			1987 → 1988	H301		
	Laguna Seca			1987 → 1988	H301		
	Monster			1996 →	H301		U301
	Monster			1996 → 2001	H301		U301
	Monster	IE		2002 →	H301		
	Monster			1998 →	H301		U301
	Montjuichi			1987 → 1988	H301		
	Paso			1984 → 1990	H301		
	S			1971 → 1990	X331		
	Santa Monica			1987 → 1988	H301		
	Sport			1984 → 1990	H301		
	Sport			2001 →	H301		U301
	SS			1971 → 1990	X331		
	SS	Special		1971 → 1990	X331		
	SS	Super Sport		1991 → 1992	H301		U301
	Supersport	USA		1991 → 1997	H301		U301
	Supersport	IE		1991 →	H301		U301
	Supersport IE			2002 →	H301		U301

= Fuel filter L300

= Fuel filter L301





kW

21

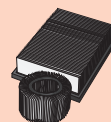
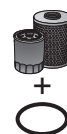
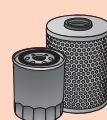
**...DUCATI**

800cc	Monster	S2R, USA, Dark, S		2003 →	H301		
	Sport	, Nuda		2003 →	H301		U301
	Supersport	USA		2003 →	H301		U301
850cc	851	(All models)	74kW	1989 → 1993	H301		U301
851cc	851	SUPERBIKE		1991 →	H301		U301
860cc	GT			1975 → 1976	X331		
864cc	Darmah 900	SS,SD		1975 → 1985	X331		
888cc	888	SP5		1993 →	H301		U301
	888	SUPERBIKE STRADA		1994 → 1995	H301		U301
	888	SUPERBIKE USA		1994 → 1995	H301		U301
900cc	907 IE			1990 → 1993	H301		U301
	907 IE	USA		1991 → 1992	H301		U301
	MH	EVOLUZIONE		2001 →	H301		
	Monster	SPECIAL, DARK, IE, USA		1993 → 2001	H301		U301
	Monster	IE		2002 →	H301		
	Sport			2002 →	H301		U301
	Supersport	SUPERLIGHT USA, CR USA, FE, IE		1991 →	H301		U301
	Supersport	FE		1998 →	H301		U301
916cc	916	SP		1994 → 1996	H301		
	916	BIPOSTO SENNA, USA		1994 → 1997	H301		
	916	BIPOSTO SENNA,		1998 →	H301		
	Monster	S4		2001 →	H301		
	Sport Tourng 4			1999 → 2003	H301		U301
944cc	Sport Tourng 2			1997 →	H301		U301
992cc	GT			2007 →	H301		
	992	Biposto Sport		2007 →	H301		
996cc	916	RACING		1997 →	H301		
	916	SPS		1997 →	H301		
	916	RACING		1998 →	H301		
	916	SPS		1998 →	H301		
	996	Biposto		1999 → 2001	H301		
	996	SPECIAL USA, SPS, SPSII, SPSIII, R, RII, S,		1999 →	H301		
	Monster	S4R, USA, S4 FOGGY		2002 →	H301		
	Sport Tourng 4S	USA		2001 →	H301		U301
998cc	998	R, MATRIX, FINAL EDITION		2002 →	H301		
	998	Monster S4R, RS		2007 →	H301		
	999			2005 →	H301		
	999	S, R		2003 →	H301		
	999 RS			2004 →	H301		
1000cc	Monster	S, S USA, Dark		2003 →	H301		
	Supersport			2003 → 2004	H301		
	GT 1000			2004 →	H301		
	Multistrada	DS, S, DS USA, S USA		2003 →	H301		
	Paul Smart	, Sport		2006 →	H301		
	S2R Monster			2006 →	H301		
	Supersport	, DS		2004 →	H301		
	Sport Tourng 3	USA		2004 →	H301		U301
	Supersport	USA		2003 →	H301		U301
1100cc	Biposto		119kW	2007 →	H301		
	Biposto	S	119kW	2007 →	H301		
	Multistrada	Hypermoard, S	70kW	2007 →	H301		

GILERA

125cc	DNA			2001 →	C320		
	Runner VX			2001 →	C320		
	Runner VX	4T		2005 → 2006	C320		

= Fuel filter L300

= Fuel filter L301

GILERA



kW

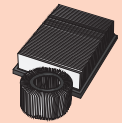
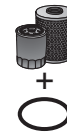
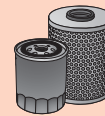

...GILERA

180cc	DNA			2001 →	C320		
200cc	Runner VXR			2003 →	C320		
	Runner VXR	4T RACE		2006 →	C320		
	Runner VXR	4T		2005 → 2006	C320		
250cc	Nexus	SP, EURO 3		2006 → 2007	C320		
350cc	Dakota				C302		
	XRT				C302		
500cc	Dakota				C302		
	Nexus			2004 →	C316		
	Nexus	EURO 3		2006 →	C316		
	Saturno			1990 → 1993	C302		
	Saturno	Piuma			C302		
570cc	XRT	600	29kW		C302		
600cc	Nord West		32kW	1991 → 1995	C302		
	RC	R	39kW		C302		

HARLEY DAVIDSON

FLH				1982 → 1984	H301		
FLHC	Classic			1982 →	H301		
FLHR	Road King			1996 → 1998	C306/C314		
FLHR	Road King			1999 → 2006	C306/C314		
FLHR	Road King (EFI)			2007 →	C306/C314		
FLHRC	Road King Classic (EFI)			2007 →	C306/C314		
FLHRCI	Road King Classic (EFI)			2003 → 2006	C306/C314		
FLHRCI	Road King Classic			1999 → 2002	C306/C314		
FLHRI	Road King (EFI)			2001 → 2006	C306/C314		
FLHRS	Road King Custom (EFI)			2007 →	C306/C314		
FLHRS	Road King Custom			2004 → 2006	C306/C314		
FLHRSE3	Screamin' Eagle Road King (EFI)			2007 →	C306/C314		
FLHRSI	Road King Custom (EFI)			2004 → 2006	C306/C314		
FLHS				1982 → 1984	H301		
FLHS				1987 → 1994	C306/C314		
FLHT	(from late 1984)			1984 → 1989	C306/C314		
FLHT	Electra Glide			1996 → 1999	C306/C314		
FLHT	Electra Glide			2000 → 2001	C306/C314		
FLHT	Electra Glide Standard			2002 → 2006	C306/C314		
FLHT	Electra Glide Standard (EFI)			2007 →	C306/C314		
FLHTC	Electra Glide Classic			2002 → 2005	C306/C314		
FLHTC	Electra Glide Classic (EFI)			2007 →	C306/C314		
FLHTC	Classic			1984 → 1998	C306/C314		
FLHTCI	Electra Glide Classic (EFI)			2003 → 2006	C306/C314		
FLHTCSE	Screamin' Eagle Electra Glide			2004 →	C306/C314		
FLHTCSE2	Screamin' Eagle Electra Glide 2			2005 →	C306/C314		
FLHTCU	Ultra Classic Electra Glide (EFI)			2007 →	C306/C314		
FLHTC-UI	Ultra Classic			1980 → 1982	C306/C314		
FLHTC-UI	Electra Glide Ultra Classic			1999 → 2002	C306/C314		
FLHTC-UI	Electra Glide Ultra Classic (EFI)			2003 → 2006	C306/C314		
FLHTC-UI	Ultra Classic			1987 → 1998	C306/C314		
FLHTCUSE2	SE Ultra Classic Electra Glide (EFI)			2007 →	C306/C314		
FLHTI	Electra Glide Standard (EFI)			2003 → 2006	C306/C314		
FLHX	Street Glide			2006 →	C306/C314		
FLHX	Street Glide (EFI)			2007 →	C306/C314		
FLHXI	Street Glide (EFI)			2006 →	C306/C314		
FLST	Heritage Softail			2006 →	C306/C314		
FLSTC	Softail Classic			1980 → 1998	C306/C314		

C306 = Chromed filter

C314 = Black filter





kW

21

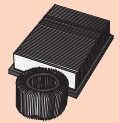
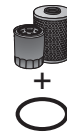
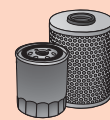
**...HARLEY DAVIDSON**

FLSTC	Heritage Softail Classic	2000 → 2006	C306/C314		
FLSTC	Heritage Softail Classic (EFI)	2007 →	C306/C314		
FLSTC	Heritage Softail Classic	1999 →	C306/C314		
FLSTCI	Heritage Softail Classic (EFI)	2001 → 2006	C306/C314		
FLSTF	Fat Boy	1989 → 1999	C306/C314		
FLSTF	Fat Boy	2000 → 2006	C306/C314		
FLSTF	Fat Boy (EFI)	2007 →	C306/C314		
FLSTFI	Fat Boy (EFI)	2003 → 2006	C306/C314		
FLSTFSE	Screamin' Eagle Fat Boy	2005 →	C306/C314		
FLSTI	Heritage Softail (EFI)	2006 →	C306/C314		
FLSTN	Softail Special	1996 →	C306/C314		
FLSTN	Softail Deluxe	2005 → 2006	C306/C314		
FLSTN	Softail Deluxe (EFI)	2007 →	C306/C314		
FLSTNI	Softail Deluxe (EFI)	2005 → 2006	C306/C314		
FLSTS	Heritage Springer	2000 → 2003	C306/C314		
FLSTS	Heritage Springer	1998 → 1999	C306/C314		
FLSTSC	Softail Springer Classic	2005 → 2006	C306/C314		
FLSTSC	Softail Springer Classic (EFI)	2007 →	C306/C314		
FLSTSCI	Softail Springer Classic (EFI)	2005 → 2006	C306/C314		
FLSTSI	Heritage Springer (EFI)	2003 →	C306/C314		
FLT		1980 → 1990	C306/C314		
FLTC	Tour Glide	1980 → 1992	C306/C314		
FLTC-U		1987 → 1994	C306/C314		
FLTC-UI	Electra Glide Ultra Classic	2000 →	C306/C314		
FLTR	Road Glide	1998 →	C306/C314		
FLTRI	Road Glide (EFI)	1999 → 2006	C306/C314		
FXD	Dyna Super Glide	1999 → 2005	C306/C314		
FXD	Dyna Super Glide (EFI)	2007 →	C306/C314		
FXD	Dyna Super Glide	1996 → 1998	C307		
FXDB	Street Bob (EFI)	2007 →	C306/C314		
FXDBI	Street Bob (EFI)	2006 →	C306/C314		
FXDC	Dynaglide Custom	1992 →	C307		
FXDC	Dyna Super Glide Custom	2005 →	C306/C314		
FXDC	Dyna Super Glide Custom (EFI)	2007 →	C306/C314		
FXDCI	Dyna Super Glide Custom (EFI)	2005 → 2006	C306/C314		
FXDI	Dyna Super Glide (EFI)	2004 → 2006	C306/C314		
FXDI35	35th Anniversary Dyna Super Glide (EFI)	2006 →	C306/C314		
FXDL	Dyna Low Rider	1999 → 2005	C306/C314		
FXDL	Dyna Low Rider	1993 → 1998	C307		
FXDL	Dyna Low Rider (EFI)	2007 →	C306/C314		
FXDLI	Dyna Low Rider (EFI)	2004 → 2006	C306/C314		
FXDS	Dyna Convertible	1996 → 1998	C307		
FXDSE	Screamin' Eagle Dyna (EFI)	2007 →	C306/C314		
FXDWG	Dyna Wide Glide	1999 → 2005	C306/C314		
FXDWG	Dyna Wide Glide	2007 →	C306/C314		
FXDWG	Dyna Wide Glide	1993 → 1998	C307		
FXDWGI	Dyna Wide Glide (EFI)	2004 → 2006	C306/C314		
FXDX	Dyna Super Glide Sport	1999 → 2005	C306/C314		
FXDXI	Dyna Super Glide Sport (EFI)	2004 → 2005	C306/C314		
FXDXT	Dyna Super Glide T-Sport	2001 → 2003	C306/C314		
FXE	Super Glide	1982 → 1984	H301		
FXEF	Fat Boy	1985 →	H301		
FXLR	Low Rider	1987 → 1994	C306/C314		
FXR	Super Glide	1982 → 1994	C306/C314		

C306 = Chromed filter

C314 = Black filter





kW

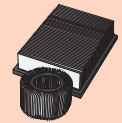
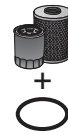
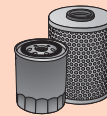

...HARLEY DAVIDSON

FXRC	Low Rider	1987 →	C306/C314		
FXRD	Grand Touring	1986 →	C306/C314		
FXRS	Low Rider	1987 → 1994	C306/C314		
FXRS	Low Glide	1982 → 1982	C306/C314		
FXRS	Low Rider Convertible	1990 → 1994	C306/C314		
FXRT	Sport Glide	1983 → 1989	C306/C314		
FXST	Softail	1987 → 1990	C306/C314		
FXST	Softail	1984 → 1985	C306/C314		
FXST	Softail Standard	2000 → 2006	C306/C314		
FXST	Softail Standard (EFI)	2007 →	C306/C314		
FXSTB	Night Train	2000 → 2006	C306/C314		
FXSTB	Night Train (EFI)	2007 →	C306/C314		
FXSTB	Night Train	1999 →	C306/C314		
FXSTBI	Night Train (EFI)	2003 → 2006	C306/C314		
FXSTC	Softail Custom	1987 → 1999	C306/C314		
FXSTC	Softail Custom (EFI)	2007 →	C306/C314		
FXSTC	Softail Custom	2000 →	C306/C314		
FXSTI	Softail Standard (EFI)	2003 → 2006	C306/C314		
FXSTS	Springer Softail	1987 → 1999	C306/C314		
FXSTS	Springer Softail	2000 → 2006	C306/C314		
FXSTSB	Bad Boy	1996 →	C306/C314		
FXSTSI	Springer Softail (EFI)	2003 → 2006	C306/C314		
FXSTSE	SE Softail Springer (EFI)	2007 →	C306/C314		
FXWG	Wide Glide	1982 → 1986	H301		
XL50	XL50 50th Anniversary Sportster (EFI)	2007 →	C306/C314		
XL53C	XL53C Sportster Custom 53	1999 → 2003	C306/C314		
883cc					
XL883	XL883 Sportster R	2002 → 2003	C306/C314		
XLH883	XLH883 Sportster	1986 → 2006	C306/C314		
XLH883	XLH883 Sportster Hugger	1999 →	C306/C314		
XLH883	XLH883 Sportster Hugger	2000 → 2003	C306/C314		
XLH883	XLH883 Sportster R Flat Track	2000 →	C306/C314		
XLH883	XLH883 (up to early 1984)	1980 → 1984	H301		
XLH883C	XLH883C Sportster Custom	2003 → 2006	C306/C314		
XLH883L	XLH883L Sportster Low	2005 → 2006	C306/C314		
XLH883R	XLH883R Sportster R	2006 →	C306/C314		
XL883	XL883 Sportster (EFI)	2007 →	C306/C314		
XL883C	XL883C Sportster Custom (EFI)	2007 →	C306/C314		
XL883L	XL883L Sportster (EFI)	2007 →	C306/C314		
XL883R	XL883R Sportster R (EFI)	2007 →	C306/C314		
1000cc					
XL1000	(from late 1984)	1984 → 1985	C306/C314		
XLS1000	XLS1000 (up to early 1984)	1980 → 1984	H301		
XLS1000	(from late 1984)	1984 → 1985	C306/C314		
XLX1000	XLX1000 (up to early 1984)	1983 → 1984	H301		
XLX1000	(from late 1984)	1984 → 1985	C306/C314		
1100cc					
XLH1100	XLH1100	1986 → 1988	C306/C314		
XLH1100	XLH1100 (up to early 1984)	1980 → 1984	H301		
1134cc					
VRSCA	V-Rod	2002 → 2006	TBA		
VRSCB	V-Rod	2004 → 2006	TBA		
VRSCR	Street Rod	2006 →	TBA		
VRSCD	Night Rod	2006 →	TBA		
VRSCSE	Screamin Eagle V-Rod	2006 →	TBA		
1200cc					
XLH1200	XLH1200 Sportster	1999 →	C306/C314		
XLH1200	XLH1200 Sportster	1988 → 1995	C306/C314		
XLH1200	XLH1200 (up to early 1984)	1980 → 1984	H301		

C306 = Chromed filter

C314 = Black filter





kW

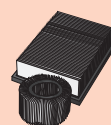
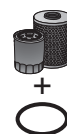
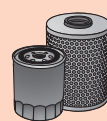

...HARLEY DAVIDSON

...1200cc	XL1200C	XL1200C Classic Sportster		1996 → 1998	C306/C314		
	XL1200S	XL1200S Sportster		1996 → 1998	C306/C314		
	XL1200S	XL1200S Sportster 1200 Sport		1999 → 2003	C306/C314		
	XL1200C	XL1200C Sportster 1200 Custom		1999 → 2006	C306/C314		
	XL1200R	XL1200R Sportster 1200 Roadster		2004 → 2006	C306/C314		
		Screamin Eagle V-Rod		2005 →	TBA		
	XL1200C	XL1200C Sportster 1200 Custom (EFI)		2007 →	C306/C314		
	XL1200L	XL1200L Sportster 1200 Low (EFI)		2007 →	C306/C314		
	XL1200R	XL1200R Sportster 1200 Roadster (EFI)		2007 →	C306/C314		
1584cc		Softail Springer Classic		2007 →	TBA		
		Softail Custom		2007 →	TBA		
		Night Train		2007 →	TBA		
1700cc		Screamin Eagle Electra Glide		2005 →	TBA		
1800cc		Screamin Eagle Softail Springer		2007 →	TBA		

HONDA

125cc	VT	C, SHADOW JC 29		1999 → 2000	X356		
	VT	C, SHADOW JC 29		2001 → 2003	X356		
	VT	C2, SHADOW		2001 → 2002	X356		
	VT	C2, SHADOW		1999 → 2000	X356		
	VT	C2, SHADOW JC 29	11kW	2001 →	X356		
	XL	V, VARADERO JC 32	11kW	2006 →	X356		
250cc	CB	Two Fifty MC 26	13kW	1994 → 2003	X304	X322	Y317
	CB	Nightawk		1992 → 2006	X304	X322	Y317
	CRE	F		2002 →	X357		
	NX	MD 21	19kW	1989 → 1995	X301		
	NX	L MD 25	25kW	1991 → 1995	X301		
	XL	R MD 03	20kW	1984 → 1986	X301		
	XL	MD 11	13, 20kW	1984 → 1986	X301		
	XR	R, RN, L		1990 → 2004	X301		
300cc	SH 300i	NF 02	20kW	2007 →	F308		
350cc	CB	F, K4 CB 350	25kW	1974 → 1985	X315		
	CB	S		1996 →	X304	X322	
	XL	K, RE-H ND 03	20kW	1985 → 1988	X301		
360cc	CB	CB 360	20, 25kW	1974 → 1985	X315		
	CJ	T CJ 360	20kW	1976 → 1984	X315		
400cc	CB	CB-1 NC 27	37, 41kW	1989 → 1992	F301		
	CB	N,T years A,B,C,D	20, 27kW	1976 → 1984	X304	X322	Y317
	CBR	Tri NC 23			F301		
	CM	T NC 01	20, 32kW	1980 → 1985	X304	X322	
	Silver Wing			2005 →	F308		
	VFR	R NC 30	43kW	1990 → 1993	F301		
	XR	R NE 03	25kW	1996 → 2004	X301		
450cc	CB	N PC 14	20, 32kW	1985 → 1991	X304	X322	Y317
	CB	S,SCG PC 17	20, 32kW	1986 → 1989	X304	X322	
	CRE	F PE05		→ 2003	X349		
	CRE	F		2004 →	X357		
500cc	CB	,R PC 26	37, 43kW	1994 → 1996	F301		J301
	CB	PC 32	25, 37, 43kW	1996 →	F306		J301
	CB	S PC 32	25, 37, 43kW	1998 → 2000	F301		J301
	CB	, S PC 32	42kW	2001 →	F306		J301
	CBF	PC 39	25, 42kW	2004 →	F306		
	CBR	F PC 15	20, 32kW	1988 → 1991	X301		J326
	CX	C PC 01	37kW	1984 → 1988	X304	X322	V313
	CX	Euro PC 06/CX 500	37kW	1979 → 1985	X304	X322	V313

C306 = Chromed filter

C314 = Black filter



HONDA



kW

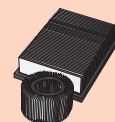
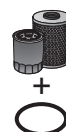
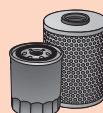

...HONDA

cc	Model	kW	Year Range	Spark Plug	Ignition Coil	Capacitor
...500cc	CX Turbo PC 03	60kW	1983 → 1988	X304	X322	
	FT PC 07	20kW	1982 → 1986	X301		
	GB PC 16	20, 28kW	1988 → 1992	X301		
	GL Silverwing PC 02	20, 37kW	1979 → 1986	X304	X322	V313
	NX (Austria) PD 08			X301		
	SL PC07	20kW	1982 → 1986	X301		
	VF F,F2 PC 12	52kW	1983 → 1989	F302		
	VT C PC 08	20, 37kW	1985 →	F302		
	VT E PC 11	20, 37kW	1984 → 1987	F302		
	XBR F-G-H PC 15	20, 32kW	1985 → 1989	X301		
	XL S PD 01	20kW	1979 → 1984	X301		
	XL R PD 02	20kW	1982 → 1986	X301		
550cc	CB F, K CB 550(K)	37kW	1971 → 1987	X315		
	CBX F, F2 PC 04	37kW	1982 → 1985	X304	X322	
600cc	CB 600F Hornet, F PC 34	37, 66kW	1998 → 2000	F301		Y341
	CB 600F Hornet, S PC 34	70kW	2001 → 2004	F308		Y341
	CB Hornet F PC 36	71kW	2005 →	F308		
	CB Hornet PC 41	75kW	2007 →	F308		
	CBF N, NA, S, SA PC 38	25, 54kW	2004 → 2006	F308		
	CBF S PC43A/B/C/F/G/H		2008 →	F308		
	CBR F PC 19	63, 37kW	1987 → 1988	F301		J326
	CBR F, FX PC 23	37, 68kW	1989 → 1991	F301		J326
	CBR F PC 25	20, 25, 37, 72kW	1992 → 1996	F301		J308
	CBR F PC 31	25, 37kW	1995 → 1999	F308		J343
	CBR F PC 35	74kW	2000 → 2001	F301		
	CBR F, Sport PC 35	80kW	2001 →	F308		
	CBR RR PC 37	86kW	2003 →	F308		
	CBR RR PC 40A	88kW	2007 →	F308		
	FJS		2001 →	F308		
	NTV RC 33		1988 → 1991	F301		J324
	NTV M RC 33		1991 → 1993	F301		J324
	Silver Wing PF 01	37kW	2005 →	F308		
	VT CD, C, Shadow PC 21	25, 29kW	1988 → 1997	F301		J328
	VT CP Shadow PC 21	25, 29kW	1998 → 2001	F301		
	XL L, LM, RM PD 04	20, 32, 37kW	1985 → 1989	X301		
XL R PD 03	20, 33kW	1983 → 1987	X301			
XL V Transalp PD 06	20, 25, 37kW	1987 → 1993	F301		J307	
XL V Transalp PD 10	25, 37kW	1999 →	F301			
XR RF-T PE 04		1994 → 1999	X301			
650cc	CB CA RC 03/RC05		1979 → 1984	X315		
	CB SC RC 08	37, 46kW	1982 → 1990	X315		
	CBX E RC 13	37, 55kW	1983 → 1987	X315		
	CX C, E, Turbo RC 11, 12, 16		1983 → 1987	X304	X322	
	FMX RD 12	28kW	2005 →	X301		
	GL D RC 10	48kW	1983 → 1987	X304	X322	
	NT Hawk GT		1988 → 1991	F301		J324
	NT Deaville RC 47	40kW	1998 → 2004	F301		J341
	NT Deaville RC 47	41, 25kW	2003 → 2005	F306		J341
	NTV Revere,T RC 33	25, 39, 42, 44kW	1988 → 1997	F301		J324
	NX Dominator RD 02	20, 44kW	1988 → 1994	X301		V312
	NX Dominator RD 08	25, 32kW	1999 → 2002	X301		V312
	SLR RD 09	29kW	1997 → 1999	X301		
	SLR Vigor RD 09A	29, 25kW	1999 →	X301		
	XL V, TRANSALP RD 10	41kW	2000 → 2003	F301		J345

HONDA





kW

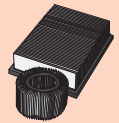
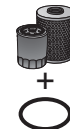
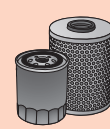

...HONDA

Capacity	Model	Year	kW	Year Range	Filter Part	Accessories	Part Number	
...650cc	XK	VI RD 10	41kW	2000 → 2003	F301		J345	
	XK	Transalp V2, Travel RD 11	39kW	2005 →	F306			
	XR	L, RL RD 06		1993 → 2000	F306			
	XR	R PE 04		2000 →	F306		J301	
	XRV	Africa Twin RD 03	37kW	1988 → 1991	F301		J307	
700cc	NT 700	Deaville RC 52	48kW	2006 →	F308			
	XL 700	Transalp RD 13A/RD 13B	44kW	2008 →	F308			
750cc	CB	C, F, F1, FZ CB 750(F,K)	46, 54kW	1970 → 1984	X315			
	CB	K RC 01	57kW	1979 → 1984	X315		J306	
	CB	C, F RC 04/ RC 06	58kW	1982 → 1984	X315		J306	
	CB	F2 Seven Fifty RC 42	20, 25, 37, 54kW	1992 → 2000	F301		J317	
	CB	F2 Seven Fifty RC 42	54kW	2001 → 2003	F306		J317	
	CBX	F RC 17	67kW	1983 → 1987	F302			
	NR	RC 40	74kW	1992 → 1994	F302			
	RVF	R RC 45	72kW	1994 → 1998	F301			
	VF	C, F, S RC 07, 09, 15, 43	25, 37, 63, 65, 66kW	1982 → 1984	F302			
	VFR	F RC 24	74kW	1986 → 1989	F301			
	VFR	F RC 36	74kW	1990 → 1995	F301			
	VFR	R RC 30	74kW	1988 → 1995	F301			
	VT	C, SHADOW RC 29	37, 46kW	1987 → 1997	F302			
	VT	C2, SHADOW RC 44	37kW	1997 → 2001	F301			
	VT	C, SHADOW RC 44A	33kW	1997 → 2000	F301			
	VT	C, SHADOW RC44A	33kW	2001 → 2006	F308		J314	
	VT	D2 Black Windo RC 48	33, 25kW	2001 →	F308			
	VT 750 C2	Shadow Spirit RC 53A		2007 →	F308			
	XLV	R RD 01	37, 45kW	1984 →	F302			
	XRV	Africa Twin RD 04	37, 43kW	1992 → 1993	F301			
	XRV	Africa Twin RD 07	37, 44kW	1993 →	F301		J314	
	800cc	Pacific Coast			1989 →	F301		
		VFR	Fi RC 46	72kW	1998 → 2001	F301		J346
VFR		RC 46	81kW	2002 → 2006	F308			
900cc	CB	F, F2 SC 01/SC09	70kW	1980 → 1985	X315		J306	
	CB	F2 Hornet SC 48	80kW	2002 →	F308			
	CBR	RR SC 28/SC33		1992 → 1999	F301		J315	
	CBR	RR SC 28/SC33		2000 → 2001	F301		J315	
	CBR	RR SC 44	108kW	2000 → 2002	F308			
	CBR	RR SC 50	110kW	2003 →	F308			
1000cc	CB	F SC 30	37, 74kW	1993 → 1996	F301			
	CBF	SC 58	75kW	2006 →	F308			
	CBR 1000RR	Fireblade SC 57	118, 126kW	2004 → 2007	F308			
	CBR 1000RR	Fireblade SC 59A	131kW	2008 →	F308			
	CBR	F SC 21	74kW	1987 → 1988	F301		J316	
	CBR	F SC 24	74kW	1989 → 1992	F301			
	CBR	F SC 24	72kW	1993 → 1999	F301			
	CBX	SC 03,06	74kW	1980 → 1987	X315			
	GL	Goldwing (K1,K2,KZ) GL1/GL2	68kW	1975 → 1987	X303	X321		
	VF	F, F2, R SC 15/SC16	74kW	1984 → 1988	F302			
	VTR	F SC 36	72kW	1997 → 2000	F301		J342	
	VTR	F SC 36	72kW	2001 →	F306		J342	
	VTR	SP-1 SC 45	97kW	2000 →	F308			
	VTR	SP-2 SC 45	99kW	2002 →	F308			
	XL	Varadero SC 01		1999 → 2002	F301		J342	
	XL	Varadero SC 01		2003 → 2006	F308		J342	

HONDA





kW

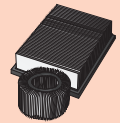
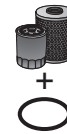
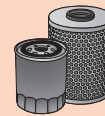

...HONDA

1100cc	CB	F, F2, R SC 05/SC11	74kW	1980 → 1987	X315		J306
	CB	R SC 08	74kW	1982 → 1985	F301		J306
	X - ELEVEN	SC 42	103kW	2000 →	F306		J340
	CBR	XX SUPER BLACKBIRD SC 35		1999 → 2006	F308		J340
	CBR	XX SUPER BLACKBIRD SC 35		1997 → 1998	F301		J339
	GL	DX SC 02	61kW	1982 → 1987	X315		
	ST	AN Pan Europeean SC 26	72kW	1990 →	F301		
	VF	C SC 12	74kW	1983 → 1987	F302		
	VT	C, SHADOW SC 23	74kW	1988 → 1993	F302		Y340
	VT	C2, SHADOW SC 32		1994 → 2000	F301		Y340
VT	C3, SHADOW SC 39		1998 → 2002	F301		Y340	
1200cc	GL	DX, E SC 14/SC16	69kW	1983 → 1987	X315		Y339
1300cc	CB	, S SC 54	85kW	2003 →	F308		
	ST	PAN EUROPEAN SC 51		2002 → 2006	F308		
	VTX	, S SC 52		2003 → 2006	F308		
1500cc	F6	Custom SC 34	72kW	1997 → 2003	F301		
	GL	Gold Wing (C)		1997 → 2002	F301		
	GL	Gold Wing (A,SE,) SC 22		1990 → 2000	F301		J338
1800cc	GL	Gold Wing (A,) SC 47		2001 →	F308		
	VTX	SC 46		2002 → 2006	F308		

HUSQVARNA

410cc	TE 410			2000 →	X337		
	TE E			1999 →	X337		
450cc	TE, TC			2003 →	X337		
510cc	TE, TC			2002 →	X337		
570cc	SMR 570			2002 →	K301		
610cc	610E			2000 →	X337		
	610S	SM		2000 →	X337		
	TE E	SM		1998 →	X337		Y323
	TE E LT			1999 →	X337		
630cc	SMR			2005 →	X337		

HYOSUNG

125cc	Aquila GV			2000 →	X327		
	Comet GT			2000 →	X327		
	Cruise II GA125F			1999 →	X327		
	Cruise II Classic GA125F			1999 →	X327		
	Exceed MS1			2001 →	X327		
	GF125			2000 →	X327		
	GT125 R			2005 →	X327		
	GT Naked 125			2001 →	X327		
	Karion RT			2005 →	X327		
	Hyper 125			2000 →	X327		
	XRX	, RX		2001 →	X327		
	250cc	Aquila GV			2005 →	X327	
Comet GT				2005 →	X327		
650cc	GV 650	Aquila		2006 →	TBA		
	GT 650	Naked		2004 →	TBA		
	GT 650	S, R		2005 →	TBA		

ITALJET

125cc	Torpedo			1999 →	X330		
	Jupiter			2000 →	X330		
	Millenium			1999 →	X330		
	Jet-Set			2000 →	X330		



kW

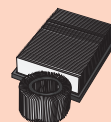
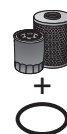
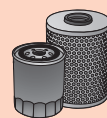

...ITALJET

150cc	Jet-Set			2000 →	X330		
	Torpeto			2001 →	X330		
	Jupiter			2001 →	X330		
	Millenium			2001 →	X330		

KAWASAKI

125cc	Eliminator 125	BN125A	9kW	1998 →	X301		
	KLX125	KLX125A/B		2003 → 2006	X328		
200cc	Z	KZ200A		1978 → 1982	X310		
250cc	EL	EL250E	13, 20, 23, 24kW	1988 → 1996	X303	X321	Y308
	EL 252	EL250B	22kW	1996 → 2003	X303	X321	Y308
	Estrella	BJ250C	13kW	1994 → 2000	X310		
	EX	E, F, H EX250	20kW	1983 → 1988	X324		
	GPZ	EX250E	18kW	1983 → 1985	X324		
	KL	A3-5 KL250A	15kW	1980 → 1984	X310		
	KLR	KL250D		1984 → 1990	X310		
	KLX	KL250B	18kW	→ 1982	X310		
	KLX	E LX250E	18kW	1993 → 1996	X301		
	KX	F		2004 → 2005	X351		
	KX	F		2006 →	X351		
	KZ	C KZ250C	20kW	1977 → 1985	X310		
	KZ	D		1980 → 1986	X303	X321	
	KZ	G		1983 →	X310		
	Z	LTD, Belt Drive		1980 → 1986	X324		
	Z	A,A2,A3,A4,J ,KZ250A,J		1979 → 1985	X324		
	ZZ-R	EX250H		1996 → 2003	X303	X321	
300cc	KLX	R KLX300A/B	19kW	1997 → 2006	X301		
305cc	GPZ	Belt Drive EX305A,B		1983 → 1990	X324		
400cc	GPZ	KZ400M/Z400GP		1980 → 1986	X303	X321	
	GPZ	ZX400A		1984 → 1987	X303	X321	J305
	KZ	B, E, J, K ,KZ500M		1980 → 1985	X303	X321	
	Z	F, J1, J2 KZ400J/ZR400B		1980 → 1986	X303	X321	
	ZR	B, F Z400	20, 30kW	1982 → 1986	X303	X321	
	ZXR	ZX400L	19, 25, 48kW	1991 → 1997	F306		
	ZXR	ZX400L		1998 →	F308		
440cc	Z 440	C, H KZ440C, H (2 Cyl.)		1980 → 1985	X303	X321	
	Z 440	LTD, Belt Drive KZ440A, D		1980 → 1985	X303	X321	Y313
450cc	KX	F		2006 →	X301		
	LTD	Belt Drive EN450A, B	20, 36kW	1985 → 1992	F302		
500cc	EN	EN500A, B	20, 25, 34, 37kW	1990 → 1995	F304		
	EN	EN500C	25, 34kW	1996 → 2002	F306		
	EN	EN500C	25, 34kW	2003 → 2006	F306		
	ER-5	ER500A, B	25, 37kW	1997 → 1998	F304		Y342
	ER-5	ER500C, D	25, 37kW	1999 → 2004	F306		Y342
	ER-5		25, 37kW	2005 →	F306		
	GPZ	S EX500A1-A4	37, 44kW	1987 → 1989	F302		J335
	GPZ	S EX500A, D	20, 25, 37kW	1990 → 1997	F306		J335
	GPZ	S EX500E	20, 25, 37, 44kW	1998 → 2003	F306		J335
	KL	A,B LE500	34kW	1980 → 1989	F304		Y308
	KLE	LE500A1	20, 25kW	1990 → 1999	F304		Y308
	KLE		20, 25, 35kW	2000 →	F306		Y308
	Z 500 B1, B2	B2 KZ500B		1980 → 1985	X303	X321	J305
	ZZ-R 500	ZX500		1995 →	F306		
550cc	GPZ	Z550H1	37kW	1980 → 1983	X303	X321	J305
	GPZ	ZX550A, A6	37, 48kW	1984 → 1991	X303	X321	J320

KAWASAKI





kW

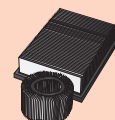
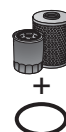
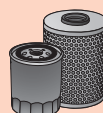

...KAWASAKI

Capacity	Model	Year	kW	Year	Spark Plug	Spark Plug	Spark Plug	
...550cc	GT	KZ550G	37kW	1982 → 1990	X303	X321	J320	
	GT	KZ550G	37kW	1982 → 1991	X303	X321	J305	
	Z 550	C1, C2, C3, C4 KZ550B, C	37kW	1981 → 1985	X303	X321	J305	
	Z 550	F ZR550A	37kW	1981 → 1985	X303	X321		
	Zephyr	ZR550B, B2	20, 25, 37kW	1990 → 1997	X303	X321	J320	
600cc	GPX	R ZX600C	25, 57kW	1987 → 1996	X303	X321	Y308	
	GPX	R ZX600C	20, 25, 57kW	1994 →	X303	X321	Y308	
	GPZ	R ZX600C1-C	37, 57kW	1986 → 1992	X303	X321	J320	
	KLR	KL600A, B	20, 31kW	1984 → 1990	X310			
	Ninja	R (USA) ZX600B	72kW	1993 → 1997	F308		Y310	
	ZL	ZL600A	54, 37kW	1985 → 1990	X303	X321	Y319	
	ZL	Eliminator ZL600A, B	25, 45kW	1995 → 2000	X303	X321	Y319	
	ZX-6R	,Ninja ZX600B, F	74kW	1995 → 1997	F306		Y310	
	ZX-6R	Ninja ZX600G, H	72kW	1998 → 2000	F306		Y310	
	ZX-6R	Ninja ZX600J	80kW	2001 → 2003	F308		J337	
	ZX-6R	Ninja ZX636A, B	25, 72, 83kW	2002 →	F308		J337	
	ZX-6R	Ninja	96kW	2005 →	F308		J337	
	ZX-6R	Ninja	72kW	2007 →	F308			
	ZX-6RR	Ninja ZX601K1A	88kW	2003 →	F308			
	ZZ-R	ZX600E, D1	20, 25, 37, 72kW	1990 → 2000	F306			
	ZZ-R	ZX600E	72kW	2001 → 2006	F308			
	650cc	ER-6n		53kW	2006 →	F308		
		ER-6f		53kW	2006 →	F308		
KLR		KL650A1-A2, C	25, 31kW	1984 → 2002	X310		Y314	
KLR		Tengai KL650B	25, 31kW	1989 → 2004	X310		Y314	
KLX		R KLX650C	25, 33kW	1993 → 1995	X310		Y314	
KLX		R KLX650R	33kW	1996 → 2001	X310			
Versys 650			47kW	2007 →	F308			
W650		EJ650A		1998 → 2000	F308			
W650		EJ650C	25, 37kW	2001 →	F308			
Z 650		KZ650D		1978 → 1980	X303	X321		
Z 650		F2,3,4 KZ650F		1980 → 1985	X303	X321		
750cc	GP	R ZX750G	68kW	1985 →	X303	X321	J323	
	GPX	R		1987 → 1989	X303	X321	Y308	
	GPZ 750	ZX750A	68kW	1983 → 1985	X303	X321		
	GPZ 750	R ZX750G	68kW	1984 → 1990	X303	X321	J323	
	GPZ 750	R ZX750F	74kW	1987 → 1992	X303	X321	Y308	
	GT	KZ750P		1983 → 1992	X303	X321		
	LTD	Belt Drive KZ750Y (2 Cyl.)		1982 → 1990	X314			
	LTD	Twin Z750H,K	59kW	1980 → 1989	X303	X321		
	VN 750	Twin VN750A	44kW	1986 → 1990	F302		Y307	
	VN 750	Vulkan VN750A1,-A5	37, 48kW	1986 → 1990	F306		Y307	
	Z 750	KZ750 2 Cyl.		1977 → 1982	X314			
	Z 750	E,L KZ750E, L		1980 → 1986	X303	X321		
	Z 750	GP KZ750R		1980 → 1983	X303	X321		
	Z 750	GP Z750A	64kW	1982 → 1988	X303	X321		
	Z750		72, 81kW	2004 →	F308			
	Z 750	Turbo ZX750E	68kW	1982 → 1989	X303	X321		
	Z750	,S Z750K1	72, 80kW	2004 → 2006	F308			
	Zephyr	ZR750C1	20, 25, 37, 56kW	1991 → 1995	X303	X321	J320	
	Zephyr	ZR750D		1995 → 1997	X303	X321	J320	
	ZR-7	ZR750F	72kW	1999 → 2000	X303	X321	Y311	
	ZR-7	ZR750F	25, 56kW	2001 →	X303	X321	J320	
	ZR-7	,S ZR750H	25, 56kW	2001 →	X303	X321	J320	

KAWASAKI





kW

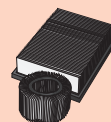
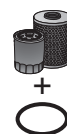

...KAWASAKI

Capacity	Model	Year	Power (kW)	Filter Part	Filter Part	Filter Part	
...750cc	ZRX ZX750H	1988 → 1992		F306			
	ZXR 750 ZX750L, J	1990 → 1995	72kW	F306			
	ZXR 750 ZX750K, L, M	1990 → 1995	72kW	F306			
	ZX-7R Ninja ZX750N, P	1996 → 2002	72kW	F306		Y311	
	ZX-7RR Ninja ZX750N, P	1996 → 2000	72kW	F306		Y311	
800cc	VN 800 CLASSIC, DRIFTER VN800A, C	1995 → 2006		F306			
	VN 800 CLASSIC, DRIFTER VN800D, B	2001 →		F306			
900cc	GPZ R (ZX 900) ZX900A1-A6, A7	1983 → 1997	74kW	X303	X321	J323	
	VN 900 Classic	2006 →	25, 41kW	F308			
	VN 900 Custom	2007 →	37kW	F308			
	Z 900 Z1	1975 → 1980	45kW	X314			
	Z 900 Z1F	1975 → 1980	45kW	X314			
	ZL Z900	1983 → 1988	45kW	X303	X321	J323	
	ZX ZX900A	1983 → 1993		X303	X321	J323	
	ZX-9R Ninja ZX900B	1994 → 1997	74kW	F306			
	ZX-9R Ninja ZX900C, D	1998 → 2001	72kW	F308		J336	
	ZX-9R Ninja ZX900E, F	2000 → 2003		F308		J336	
	1000cc	GPZ RX ZX1000A1-2	1985 → 1994	74kW	X303	X321	J323
		GPZ ZX00B	1995 → 2000	72kW	X303	X321	J323
GTR ZG100A		1996 → 2000	72kW	X303	X321	J323	
GTR ZG10A		2001 → 2003	72kW	X303	X321	J323	
KL 1000		2004 → 2005		K301			
KZ 1000 A, MK II, ST Z1000		1979 → 1983		X314			
LTD 1000 T1000K		1983 → 1987		X303	X321		
Z 1000 K1, J, R KZTOOR		1980 → 1986	72kW	X303	X321		
Z 1000 R2 ZX1000A		1980 → 1986		X303	X321		
Z1000		2003 → 2006	72, 93kW	F308			
Z 1000		2007 →	72kW	F308			
Z1R KTT00D		1978 → 1980		X303	X321		
Z1R II KTT00D		1978 → 1980		X303	X321		
ZG A ZG100A		1985 → 1997	72kW	X303	X321	J323	
ZL ZL100A		1985 → 1988	74kW	X303	X321	J323	
ZX ZXT00B		1988 → 1992	74kW	X303	X321		
ZX 10 ZXT00B1-3		1987 → 1991	74kW	X303	X321		
ZX -10R Ninja		2004 → 2006	129kW	F308			
1100cc		GPZ ZXT10A	1983 → 1984	72, 74kW	X303	X321	
		GPZ ABS ZXT10E	1995 → 2000	72kW	X303	X321	
	KZ KZ1100A	1980 → 1985		X303	X321		
	LTD Z1100K	1983 → 1987	68kW	X303	X321		
	Z GPST KZT10A, B	1980 → 1987		X303	X321		
	Zephyr ZRT10A	1992 → 1995		X303	X321		
	Zephyr ZRT10B	1995 → 1999		X303	X321	Y337	
	ZRX ZRT10C	1997 → 1999	72kW	X303	X321	Y337	
	ZRX ZRT10D	1999 → 2003	72kW	X303	X321	Y337	
	ZZ-R ZXT10C	1989 → 1992	72, 74kW	X303	X321		
	ZZ-R ZRT10D	1993 → 2000	72kW	X303	X321	Y312	
	ZZ-R ZRT10G	2001 → 2003	72kW	X303	X321	Y312	
	1200cc	ZRX ,R, S ZR12A, B, C	2001 → 2006		X303	X321	Y337
ZX-12R Ninja ZX12A		2000 → 2001		F308			
ZX-12R Ninja ZX12B		2002 → 2006		F308			
ZZ-R ZX12C		2002 → 2004		X303	X321	Y312	
1300cc	Z DFi Z1300A1-A3	1980 → 1985	74kW	X314			
	ZG DFi ZG1300A1-5	1980 → 1987	74kW	X314			
1400cc	GTR	2007 →		F308			
	ZZR	2006 →		F308			

KAWASAKI





kW

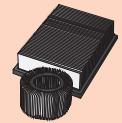
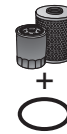
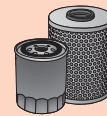

...KAWASAKI

1500cc	VN	ALL MODELS		1996 → 2006	F308		Y338
	VN	SE VNT50A, B	20, 25, 37, 47kW	1992 → 1995	F306		Y307
	VN 15	Mean Sreak VN1500P	53kW	2002 → 2003	F308		Y338
1600cc	VN	CLASSIC		2003 → 2006	F308		
	VN	Mean Sreak	54kW	2004 → 2006	F308		Y338
2000cc	VN			2004 → 2006	F308		

KTM

125cc				1998 →			Y301
200cc				1998 →			Y301
250cc				1998 →			Y301
		EXC Racing		2003 →	X320 (Long Filter)		
		EXC Racing		2003 →	X335 (Short Filter)		
		SX 4T		2005 →	TBA (Long Filter)		
		SX 4T		2005 →	X335 (Short Filter)		
		SX-F		2005 →	TBA (Long Filter)		
		SX-F		2005 →	X335 (Short Filter)		
		EXC-F		2007 →	TBA (Long Filter)		
		EXC-F		2007 →	X335 (Short Filter)		
300cc		SX, EXE		1998 →			Y301
350cc		EGS, EXC	40kW	1993 →	X320		
380cc				1998 →			Y301
400cc		SC	18kW	1994 → 1997	X320		
		EGS, EXC	22kW	1994 → 1997	X320		Y300
		EGS, EXC	22kW	1994 → 1997	F303 (Additional Filter)		Y300
		EGS, EXC	22kW	1997 → 2000	X320		Y315
		EGS, EXC	22kW	1997 → 2000	F303 (Additional Filter)		Y315
		EXC, SX, EGS		2000 →	X320 (Long Filter)		
		EXC, SX, EGS		2000 →	X335 (Short Filter)		
450cc		SX, EXC, MXC		2003 →	X320 (Long Filter)		
		SX, EXC, MXC		2003 →	X335 (Short Filter)		
		SMR		2005 →	X335 (Short Filter)		
		SMR		2005 →	TBA (Long Filter)		
		EXC - R		2007 →	X335 (Short Filter)		
		EXC - R		2007 →	TBA (Long Filter)		
		SX-F		2007 →	X335 (Short Filter)		
		SX-F		2007 →	TBA (Long Filter)		
477cc		SX-F		2007 →	X335 (Short Filter)		
		SX-F		2007 →	TBA (Long Filter)		
500cc		GS		1982 → 1984	X320		
520cc		EXC		2000 →	X320 (Long Filter)		
		EXC		2000 →	X335 (Short Filter)		
		SX		2000 →	X320 (Long Filter)		
		SX		2000 →	X335 (Short Filter)		
		SX, MXC, EXC		1999 → 2003	X320 (Long Filter)		
		SX, MXC, EXC		1999 → 2003	X335 (Short Filter)		
525cc		SMR		2004 →	X320 (Long Filter)		
		SMR		2004 →	X335 (Short Filter)		
		SX, MXC		2002 → 2006	X320 (Long Filter)		
		SX, MXC		2002 → 2006	X335 (Short Filter)		
		EXC Racing		2003 →	X320 (Long Filter)		
		EXC Racing		2003 →	X335 (Short Filter)		
530cc		EXC		2007 →	TBA (Long Filter)		
540cc		SX Racing		2002 →	X320 (Long Filter)		
		SX Racing		2002 →	X335 (Short Filter)		

KTM

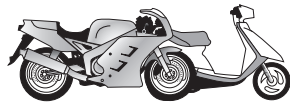

kW

21

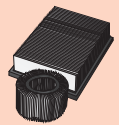
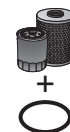
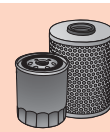

...KTM

560cc	SMR		2007 →	X320 (Long Filter)	
	SMR		2007 →	X335 (Short Filter)	
600cc	GS		1984 → 1986	X320	
609cc	SX,EXC	43kW	1993 →	X320	Y300
620cc	Duke E	37kW	1997 →	X320	Y315
	Duke E	37kW	1997 →	F303 (Additional Filter)	Y315
	SC		1994 → 1997	X320	Y300
	SX		1994 → 1997	X320	Y300
	EGS		1994 →	X320	Y315
	EGS		1994 →	F303 (Additional Filter)	Y315
	EXC		1994 → 1997	X320	Y315
	EXC		1994 → 1997	F303 (Additional Filter)	Y315
625cc	SXC		2002 → 2005	X320 (Long Filter)	
	SXC		2002 → 2005	X335 (Short Filter)	
	SMC		2004 → 2005	X320	
640cc	DUKE		1999 → 2006	X320 (Long Filter)	
	DUKE		1999 → 2006	X335 (Short Filter)	
	LC4		1999 → 2006	X320 (Long Filter)	
	LC4		1999 → 2006	X335 (Short Filter)	
660cc	SUPERMOTO		2002 → 2003	X320 (Long Filter)	
	SUPERMOTO		2002 → 2003	X335 (Short Filter)	
	LC4 Rally		2003 →	X320 (Long Filter)	
	LC4 Rally		2003 →	X335 (Short Filter)	
	SMC		2004 → 2005	X320 (Long Filter)	
	SMC		2004 → 2005	X335 (Short Filter)	
	Supermoto, Prestige		2007 →	X335 (Short Filter)	
	Supermoto, Prestige		2007 →	X320 (Long Filter)	
950cc	ADVENTURE,S		2003 → 2005	X340	
	LC8 Rally		2004 →	X340	
	Supermoto		2005 →	X340	
	Super Enduro R, Supermoto		2006 →	X340	
1000cc	Superduke		2005 →	X340	
	Aventure S		2006 →	X340	
	Superduke RC8		2007 →	X340	

KYMCO

125cc	Grand Dink 4T		2000 →	TBA	
250cc	Xciting	14kW	2006 →	TBA	
	Grand Dink 4T	15kW	2000 →	TBA	
500cc	Xciting	32kW	2005 →	F307	

LAVERDA

650cc	Formula	52kW	1995 → 1996	C302	U306
	Ghost	52kW	1995 →	C302	U306
	Hidalgo 668	52kW	1995 →	C302	U306
	Sport	52kW	1995 → 1996	C302	U306
750cc	Diamante	62, 68kW	1997 →	C302	U305
	Formula	62, 68kW	1997 →	C302	U305
	Ghost	62, 68kW	1997 →	C302	U305
	S	Formula	62, 68kW	1997 →	C302
1000cc	SFC 1000	(Mot. Aprilia)	104kW	2004 →	X312

LAVERDA



kW

21

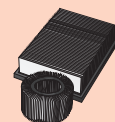
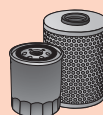
**MALAGUTI**

180cc	180 R Madison		2002 →	C320		
200cc	200 S Madison		2003 →	C320		
	200 F12 Phantom Max		2004 →	C320		
250cc	250 F12 Phantom Max		2003 →	C320		
	250 S Madison		2002 →	C320		
400cc	400 Madison		2002 →	TBA		
500cc	GT 500 Spider Max		2005 →	C316		

MBK

125cc	Flame R (4Takt)	7kW	1995 → 1999	X313		
	Flame XC Flame		2000 →	X313		
	Flame Vertex		1997 →	X313		

MOTO GUZZI

100cc	California	ALUMINIUM, TITANIUM	2003 → 2005	C305		U307
350cc	Nevada	NEW TYPE	1993 → 1997	X329		
	Nevada 350	CLUB	1998 → 1999	X329		
	Nevada 350	OLD TYPE	1992 → 1993	X329		
	NTX		1986 → 1990	X318		
	V35	FLORIDA	1986 → 1990	X318		
	V35 Carabinieri	PA	1992 → 2001	X329 or X318		
	V35 Carabinieri		1990 → 1991	X329		
	V35 II		1980 → 1985	X318		
	V35 III		1985 → 1987	X329 or X318		
500cc	V50	PA	1992 → 2001	X329 or X318		
	V50 III		1980 → 1984	X318		
	V50 III Polizia	PA OLD TYPE	1982 → 1990	X318		
650cc	65GT		1988 → 1989	X318		U300
	NTX		1986 → 1990	X318		U300
	V65	CUSTOM	1983 → 1986	X318		U300
	V65	FLORIDA	1985 → 1992	X329 or X318		U300
	V65 Polizia	PA-NEW TYPE	1988 → 1995	X329 or X318		U300
750cc	750 Polizia	PA SECOND SERIES	1995 → 2002	X329		U300
	750SP		1990 → 1992	X329		U300
	750X Polizia	PA FIRST SERIES	1992 → 1994	X329		U300
	Breva		2003 → 2006	X329		
	Nevada	CLASSIC	2004 → 2006	X329		
	Nevada		2002 → 2003	X329		U300
	Nevada	CLUB	1998 → 2001	X329		U300
	Nevada	NEW TYPE	1993 → 1997	X329		U300
	Nevada	OLD TYPE	1991 → 1993	X329		U300
	Strada		1993 → 1995	X329		U300
	Targa		1990 → 1992	X329		U300
	V75	PA NEW TYPE	1996 → 2001	X329		U300
	V75	PA OLD TYPE	1992 → 1996	X329		U300
	850cc	850 Le Mans III		1981 → 1984	H302	
850 T5		III SERIES	1984 → 1987	H302		U300
850 T5 Polizia		CC-PA (NC)	1995 → 2001	C305		U300
850 T5 Polizia		CC-PA VR36416-40000	1994 → 1995	C305		U300
850 T5 Polizia		CC-PA	1988 → 1993	H302		U300
850 T5 Polizia		CC-PA OLD TYPE	1985 → 1989	H302		U300
Breva			2006 → 2007	C305		
Griso			2006 → 2007	C305		
1000cc	1000 SP		1979 → 1983	H302		
	1000GT		1987 → 1991	H302		U300
	1000S		1989 → 1994	H302		U300



kW

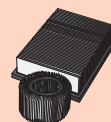
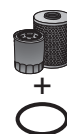
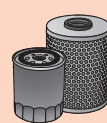

...MOTO GUZZI

...1000cc	1000SP II		1984 → 1987	H302		U300
	1000SP III		1989 → 1994	H302		U300
	California II		1981 → 1987	H302		U300
	California III	INJECTION	1990 → 1993	H302		U300
	California III	CARBURATOR	1988 → 1993	H302		U300
	Daytona	RS	1997 → 1998	C305		U307
	Daytona	RACING	1996 → 1996	C305		U307
	Daytona		1992 → 1995	H302		U307
	Le Mans		1984 → 1993	H302		U300
	Quota		1992 → 1997	H302		U307
	Strada		1993 → 1994	H302		U300
	V10 Centauro		1997 → 1999	C305		U307

1100cc	Breva		2005 → 2007	C305		
	California	VINTAGE	2006 → 2007	C305		U307
	California	CLASSIC-TOURING	2006 → 2007	C305		U307
	California	EV, EV TOURING	2003 → 2005	C305		U307
	California	STONE-METAL	2002 → 2003	C305		U307
	California	SPECIAL SPORT-ALUMINIUM	2002 → 2003	C305		U307
	California	EVPI.	2002 → 2002	C305		U307
	California	STONE-SPORT	2001 → 2002	C305		U307
	California	EV	2001 → 2002	C305		U307
	California	JAKAL	1999 → 2001	C305		U307
	California	SPECIAL	1999 → 2000	C305		U307
	California		1994 → 1997	C305		U307
	California EV	(V11 EV USA)	1997 → 2000	C305		U307
	California Stone		2003 → 2005	C305		U307
	Griso		2005 → 2007	C305		
	Quota 1100	ES	1999 → 2001	C305		U307
	Sport 1100	INIEZIONE	1996 → 1999	C305		U307
	Sport 1100	CARBURATOR	1994 → 1996	C305		U307
	Sport Corsa		1998 → 1999	C305		U307
	V11	SPORT	1999 → 2001	C305		U307
	V11 Cafe Sport	BALLABIO, COPPA ITALIA	2003 → 2005	C305		U307
	V11 Le Mans	NAKED, SPORT	2003 → 2005	C305		U307
	V11 Le Mans		2002 → 2002	C305		U307
	V11 Le Mans	NAKED	2001 → 2002	C305		U307

1200cc	Norge		2006 → 2007	C305		
	Sport		2006 → 2007	C305		

MV AGUSTA

750cc	Brutale	S		2003 → 2005	F305	
	F4	F4, F4 Series ORO		1998 → 2003	F305	
	F4	S, SPR	103kW	2000 → 2002	F305	
	F4	S 1+1		2000 → 2002	F305	
	F4	Senna	103kW	2001 → 2003	F305	

910cc	Brutale	R, S		2005 → 2006	F305	
--------------	---------	------	--	-------------	------	--

1000cc	F4	S, R		2005 → 2006	F305	
	F4	Tamburini		2004 → 2005	F305	
	F4	Senna		2006 →	F305	

MZ

125cc	125 SX		11kW	2001 →	X305	
	125 SM		11kW	2000 →	X305	
	125 RT	Supermoto,	11kW	2005 →	X305	
	125 SM	Gangsta, Cup Replica	11kW	2005 →	X305	
	Moskito 125			2001 →	X305	



MZ



kW

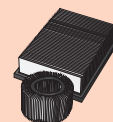
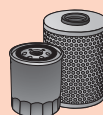

...MZ

500cc	Green Star		20, 25kW	1996 → 2000	X305		
	MZ		20kW	1990 → 1993	X305		
	Red Star	Classic		1997 → 2000	X305		
	Saxon	Fun	20, 25kW	1992 → 1994	X305		
	Saxon	Tour	20, 25kW	1993 → 1998	X305		
	Saxon	Voager, Country	20, 25kW	1993 → 1999	X305		
	Silver Star	Classic		1993 → 1998	X305		
	Silver Star	Gespann	25kW	1994 → 1998	X305		
660cc	Baghira	Enduro	36kW	1997 → 2000	X302		
	Baghira	Black Panther		1999 →	X302		
	Baghira	Street Moto		1999 →	X302		
	Baghira	Forest	25, 35kW	1999 →	X302		
	Mastiff		25, 35kW	1997 → 2001	X302		
	Skorpion	Gespann 3YF	35kW	1994 →	X302		
	Skorpion	Race Replica 660 3YF	37kW	1994 → 2000	X302		
	Skorpion	Sport, Tour 3YF	25, 35kW	1994 → 2001	X302		
	Skorpion	Supersport, Traveller 3YF	44kW	1995 → 2000	X302		
	Supermoto	, S	25, 35kW	2005 →	X302		
850cc	Kobra	3VD	67kW	1994 → 1999	X302		
1000cc	1000 S		85kW	2004 →	C301		
	1000 SF, ST, FS		83kW	2005 →	C301		

NHUSABERG

450cc	FE 450	FS 450 E		2000 →			
550cc	FC 550/4	/6		2000 →	X320		
600cc	FC 600			2000 →	X320		
650cc	FE 650	FX 650		2000 →	X320		
	FS 650			2000 →	X320		

PEUGEOT

125cc	Eliseo			1999 → 2001	X325		
	Eliseo	, Advantage		2001 → 2003	X325		
	Elystar			2002 → 2003	X325		
	Geopolis			2006 →	X325		
	Ludix			2004 →	X325		
	Looxor			2003 →	X325		
	Jet force	, Kompressor		2003 →	X325		
	Satelis	, Kompressor		2006 →	X325		
150cc	Eliseo			1999 → 2003	X325		
	Elystar			2001 → 2004	X325		
	Looxor			2003 →	X325		
250cc	SV 250			2001 →			
	Satelis 250			2006 →	X325		

PIAGGIO

125cc	Beverly	eng. LEADER		2001 → 2003	C320		
	Beverly	RST		2004 → 2006	C320		
	Hexagon	GTX eng. LEADER		2000 → 2004	C320		
	FLY			2005 →	C320		
	Liberty	eng. LEADER	8kW	2000 → 2005	C320		
	Skipper	eng. LEADER		2000 → 2004	C320		
	Vespa	ET4	8kW	1994 → 1999	X330		Y309
	Vespa	ET4 eng. LEADER		2000 →	C320		
	Vespa	LXV 4T		2006 →	C320		
	Vespa	LX		2005 → 2006	C320		
	Vespa	LX EURO 3		2006 → 2007	C320		
	Vespa	GRATURISMO		2006 →	C320		



kW

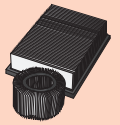
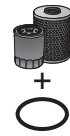
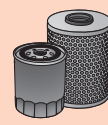

...PIAGGIO

...125cc	Vespa	GRATURISMO		2003 → 2005	C320		
	X8			2004 → 2006	C320		
	X8	STREET EURO2		2006 →	C320		
	X8	PREMIUM EURO2	11kW	2004 →	C320		
	X9	, EVOLUTION eng. LEADER	11kW	2000 →	C320		
	ZIP	eng. LEADER		2000 → 2005	C320		
	Sfera		8kW	1994 →	X330		Y309
150cc	Beverly	4T eng. LEADER		2002 →	C320		
	FLY			2005 →	C320		
	Liberty	4T eng. LEADER		2000 → 2002	C320		
	Skipper	ST eng. LEADER		2000 → 2002	C320		
	Vespa	ET4 eng. LEADER		2000 →	C320		
	Vespa	LX		2005 → 2006	C320		
	Vespa	LX EURO 3		2006 → 2007	C320		
	X8	STREET EURO2		2006 →	C320		
	X9	ET4 eng. LEADER		2000 →	C320		
180cc	Hexagon	Super, GTX eng. LEADER		2000 →	C320		
	X9	eng. LEADER		2000 → 2004	C320		
200cc	Beverly	GT eng. LEADER		2001 → 2003	C320		
	Liberty	RST, 4T, SPORT		2004 → 2006	C320		
	Vespa	GRATURISMO		2006 → 2006	C320		
	Vespa	GRATURISMO		2003 → 2005	C320		
	X8			2005 → 2006	C320		
	X9	EVOLUTION eng. LEADER		2000 → 2003	C320		
250cc	Beverly	SPORT,RST, EURO3, GT		2003 → 2006	C320		
	MP3			2006 → 2007	C320		
	Vespa	GTV		2006 → 2006	C320		
	Vespa	GTS I.E.		2005 → 2006	C320		
	X8	i.e.		2005 → 2006	C320		
	X9	4T		2000 → 2003	C320		
	X9	EVOLUTION		2004 → 2006	C320		
400cc	Beverly			2006 →	C316		
	X8	i.e.		2006 →	C316		
500cc	Beverly			2002 → 2006	C316		
	X9	EVOLUTION		2003 → 2007	C316		
	X9			2002 → 2003	C316		

SACHS

125cc	Roadster 125			1998 → 2003	X302		
650cc	Roadster 650			2000 →	X308		
800cc	Roadster 800			2000 → 2004	K301		
	B-805	S-805, Spezial Edition		2002 → 2003	K301		

SUZUKI

125cc	AN			1991 → 2000	X327		
	CS 125			1983 → 1987	X328		
	UH 125	Burgman BP		2002 → 2005	X327		
	UH 125	Burgman BP		2006 →	X327		
	UE 125	WVBH		2001 →	X327		
	DR	SE,SJ SF43B, SF44A	9kW	1994 → 1995	X328		
	UC 125	Epicuro AX121, AX311		1999 → 2003	X327		
	GN	NF41A		1982 → 2000	X327		
	RV 125	Van Van WVB T1		2002 → 2005	X328		
	RV 125	Van Van WVB T1		2006 →	X328		
	VL	Intruder A4131, A4211		2000 → 2004	X319		
	VL	Intruder WVA4		2005 →	X319		





kW

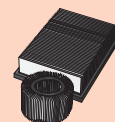
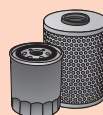

...SUZUKI

...125cc	GZ	Maurauder AP		1998 → 2005	X327		
	GZ	Maurauder AP		2006 →	X327		
150cc	AN			1996 → 2000	X327		
	Epicuro			1999 →	X327		
	Burgman			2002 → 2006	X327		
200cc	UH 200	Burgman		2007 →	X327		
250cc	AN 250	Burgman AN121	12kW	1998 → 2005	X328		
	DR	S, SZ-H, EZ-J SJ41A, NJ42A	9, 16, 14kW	1982 → 1996	X328		
	GN	D, E, F, ED, L-N NJ42A	9kW	1982 → 2000	X319		
	GNX	E	13kW	1982 →	X307	X323	
	GSX	ET, EX, EZ, L, T, T1 ,GJ53B		1982 → 1985	X307	X323	
	GZ	MARAUDER AR		1999 → 2005	X319		
	GZ	MARAUDER		2006 →	X319		
	RM-Z			2004 → 2006	X351		
	TU	X		1997 → 2001	X319		
	VL	INTRUDER A5		2000 → 2007	X319		
350cc	DR	N, S, SE, SH, SZ, L-P SK42B	22, 23, 24kW	1990 → 2000	X319		
400cc	DR	ST, SX		1980 → 1982	X319		
	Burgman	X	25kW	1999 → 2000	X328		
	Burgman			1999 → 2005	X328		
	Burgman			2006 →	X327		
	DR-Z	Y BE, BF		1999 → 2003	X345		
	DR-Z	E, S WVBC	29kW	2000 → 2005	X345		
	DR-Z	Z WVB8	29kW	2006 →	X345		
	GN	LT, TD, TX, TT GS400	20kW	1982 → 1984	X319		
	GS	R, EC, N, EN, X GL51F	20kW	1982 → 1985	X307	X323	
	GSF	Bandit GK75B	37kW	1990 → 1995	X307	X323	Y302
	GSX	E,L, FX, LX, S GS40X	20kW	1983 → 1986	X307	X323	
	GSX	FWSE, FWSD GK71A		1982 → 1984	X307	X323	
	GSX	EE, ED, EZ, FD, FX, FZ, LT, LX, S, TD GK51	31kW	1982 → 1986	X307	X323	
	GSX	EF, EG, SE, SF, SG GK53C		1982 → 1988	X307	X323	
450cc	GS	E, L, S GL51D	31kW	1988 → 1990	X307	X323	
	GS	L, T, X GS450	31kW	1982 → 1987	X307	X323	
	RM-Z			2005 → 2006	X351		
500cc	DR	D, R, S, SX-Z DR500	20kW	1982 → 1984	X308		
	GS	E, K, L,M, N		1988 → 2000	X307	X323	J303
	GS	E		1988 → 2002	X307	X323	
	GS	E GM51B		2001 → 2002	X307	X323	J303
	GS	GM51D	39kW	1989 → 1996	X307	X323	J303
	GS	WVBK	32, 33kW	2001 → 2005	X307	X323	J303
	GS	WVBK4	35kW	2004 → 2005	X307	X323	J303
	GS	WVBK4	25, 35kW	2006 →	X307		
550cc	GS	E, ES GS550		1983 → 1986	X307	X323	
	GS	MX, LN, T	37kW	1983 → 1986	X307	X323	
	GSX	E GN71D		1983 → 1987	X307	X323	
	GT	AB, K, M			X307	X323	
600cc	DR	R, S SN41A, SN41B	32, 33kW	1985 → 1990	X308		
	GSF	Bandit GN77B	25, 57kW	1995 → 1999	K301		J304
	GSF	Bandit WVA8	25, 57kW	2000 → 2005	K301		J333
	GSR	WVB9	72kW	2006 →	K301		
	GSX	F, FU, FU2, EF, ES, FJ GN72B		1988 → 1989	K301		J322
	GSX	F, FU, FU2, EF, ES, FJ GN72B		1990 → 1997	K301		Y336
	GSX	FW, FX AJ111		1998 → 1999	K301		Y336
	GSX	FW, FX AJ121		2000 →	K301		Y336

SUZUKI



kW

21

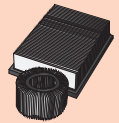
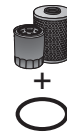
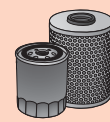

...SUZUKI

...SUZUKI								
600cc	GSX	F AJ3111		2000 →	K301		Y336	
	GSX	WN, WP		1992 → 1993	K301		J304	
	GSX	R AD		1997 → 2001	K301		Y335	
	GSX	R WVBG		2001 → 2003	K301		J334	
	GSX	R WV B2		2004 → 2005	K301			
	GSX	R WVCE		2006 →	K301			
	RF	R GN76B	25, 37, 72kW		1993 → 1997	K301		J325
	VS	GLS Intruder VN51B	25, 33kW		1995 → 1997	K301 (Front Intake)		V310
	VS	GLS Intruder VN51B	25, 33kW		1995 → 1997	K301 (Back Intake)		J313
	VS	GLV Intruder VN51B	25, 33kW		1998 →	K301 (Front Intake)		V310
	VS	GLV Intruder VN51B	25, 33kW		1998 →	K301 (Back Intake)		J313
	650cc	AN 650	AN Burgmann WVBU11		2002 → 2004	K301		
		AN 650	AN Burgmann WVBU11		2005 →	K301		
DL		V-STROM WV B1	53kW		2003 → 2004	K301		
DL		V-STROM WV B1	25, 53kW		2005 →	K301		
DR		SP41B, SP42P			1990 → 1997	X308		Y304
DR		R, RE, RS, RSE SN41B			1991 → 1995	X308		Y304
DR		SE SP43B, SP44B			1990 → 1997	X308		Y304
DR		SET, SEW SP46B			1997 →	X308		
GR		E, D, XD, G, XG GP51A	37kW		1982 → 1985	X307	X323	
GS		G, GS, X - Z GP51A	53kW		1981 → 1986	X307	X323	
GSF		Bandit WV B5			2005 →	K301		
GX		GP51A	37kW		1984 → 1987	X307	X323	
LS		Savage NP41B	20, 25kW		1986 → 1990	X308		
LS		Savage, Pathfinder NP41B	23kW		1991 → 2004	X308		U308
SV		X, SX AV			1999 → 2002	K301		Y334
SV		WVBY			2003 → 2004	K301		
SV		WVBY	53kW		2005 →	K301		
SV		WVBY	25, 53kW		2006 →	K301		
XF		FREEWIND AC111			1997 → 2001	X308		
XF		FREEWIND AC211			1998 →	X308		
700cc	GV	GL		1984 → 1989	K301 (Front Intake)		V310	
	GV	GL		1984 → 1989	K301 (Back Intake)		J313	
750cc	DR			1988 → 1989	X308			
	GS	BD, ET		1979 → 1982	X309			
	GS	D, E, ED, ESD, L, P, S		1981 → 1984	X307	X323		
	GSX	R		1992 → 1995	K301		J304	
	GSX	R		1994 → 2000	K301		V307	
	GSX	F WVAK		2003 → 2004	K301		Y336	
	GSX	F, K5, K6 WVAK		2005 →	K301			
	GSX	F, FX, FY AK		1999 →	K301		Y336	
	GSX	W, XY AE121		1998 →	K301		Y336	
	GSX	F AE		1998 → 2000	X307	X323	V307	
	GSX	F AE		2001 → 2000	K301		Y336	
	GSX	E, EZ, S, T GR71A		1981 → 1985	X307	X323	V307	
	GSX	S Kantana GR71A		1983 → 1986	X307	X323	V307	
	GSX	EF GR72A		1983 → 1987	X307	X323		
	GSX	EE, ESD, ESE GR78A		1985 → 1988	X307	X323		
	GSX	F, K, L, M, N, R GR78A		1989 → 1997	K301		Y336	
	GSXR	GR77AB, B	72, 74kW		1988 → 1991	K301		J321
	GSXR	R, RG GR75A	74kW		1985 → 1987	C303		Y335
	GSXR	F, G, H GR75A, AB	72kW		1989 → 1997	K301		Y335
	GSXR	J, K, L, M GR77AB, B	74kW		1988 → 1991	K301		J321
	GSXR	RK GR79B	74kW		1989 → 1993	K301		Y335

SUZUKI



kW

21

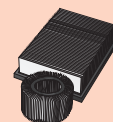
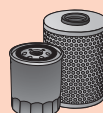

...SUZUKI

Capacity	Model	Year	kW	Filter	Gasket	Filter
...750cc	GSXR L, M GR7AB, D	1990 → 1992	74kW	K301		J321
	GSXR T-V GR7DB	1995 → 2000	72kW	K301		J334
	GSXR W GR7BB	1993 → 1996	72kW	K301		J304
	GSXR Y WVBD	2000 → 2003		K301		J334
	GSXR WVB3	2004 → 2005		K301		
	GSXR WVCF	2006 →		K301		
	VS GLF VR51B	1985 → 1986	37kW	K301 (Front Intake)		V310
	VS GLF VR51B	1985 → 1986	37kW	K301 (Back Intake)		J313
	VS GL, Intruder VR51B	1987 → 1989	37kW	K301 (Front Intake)		V310
	VS GL, Intruder VR51B	1987 → 1989	37kW	K301 (Back Intake)		J313
	VS GL, Intruder VR51B	1990 → 1998		K301 (Front Intake)		V310
	VS GL, Intruder VR51B	1990 → 1998		K301 (Back Intake)		J313
800cc	DR S SR42A, B	1990 → 2000		X308		
	VL Intruder, Volusia WVBM	2001 → 2004		K301		
	VL Intruder, Volusia WVBM	2005 →	38kW	K301		
	VL Intruder C800 WVBM	2006 →	39kW	K301		
	VS GL Intruder VS52B	1992 → 2004	25, 37kW	K301 (Front Intake)		V310
	VS GL Intruder VS52B	1992 → 2004	25, 37kW	K301 (Back Intake)		J313
	VX VS51B	1990 → 1997	25, 37, 45kW	K301 (Back Intake)		V304
	VZ INTRUDER WVB4	2005 → 2007		K301		
	VZ Marauder AF111	1997 → 2004		K301		
850cc	GS G, GE, GL GS72A	1980 → 1986	59kW	X307	X323	
	GS GT (E,G) GS72A	1980 → 1986	69kW	X307	X323	
900cc	RF GT73B	1993 → 2000	72kW	K301		J325
1000cc	DL V-Strom WVBS	2002 → 2003	72kW	K301		
	DL V-Strom WVBS	2004 →	72kW	K301		
	GS GG, GT-X GU71A	1986 → 1989	67, 69kW	K301		
	GSX E, S	1986 → 2000		K301		
	GSX R WVBL, WV BZ	2001 → 2004		K301		J334
	GSX R WV B6	2005 → 2006		K301		
	GSX R WV B6	2006 →		K301		
	SV S WV BX	2003 → 2005		K301		
	SV S WV BX	2006 →		K301		
	TL SV, SX AG311	1998 → 2000	72kW	K301		J332
TL R	1998 → 2002		K301			
1100cc	GS E,T,S	1978 → 1982		X307	X323	
	GS GE, GF, GG, GT-X, GU71A, GS100G	1982 → 1989	69kW	K301		
	GSX GE, GG, GF GU71A	1982 → 1987		X307	X323	
	GSX EFEG, EFG, ESE GV71C	1983 → 1987		X307	X323	
	GSX EZ, ESD GU71B	1986 → 1990	74kW	K301		
	GSX GM, GN, GR GV74A	1991 → 1995	72kW	K301		
	GSX Kantana GS1100	1982 → 1985	74kW	X307	X323	
	GSX F GV72C	1988 → 1996	78kW	K301		J322
	GSX R GU74C	1986 → 1988		K301		
	GSX R GV73C, GU74C	1986 → 1994		K301		J321
	GSX R GU75C	1993 → 1997	72kW	K301		J304
	1200cc	GSF S Bandit GV75A	1996 → 1998		K301	
GSF Bandit, S Bandit GV75A		1999 → 2000		K301		J304
GSF Bandit WVA9		2001 → 2005		K301		J333
GSF Bandit WVA9		2006 →		K301		
GSF Bandit WVCB		2006 →		K301		
GSX X, Y JS1A3		1999 → 2001	72kW	K301		
GSX R JS1A3		2001 → 2002	72kW	K301		
GV GL		1987 → 1988	69kW	K301		

SUZUKI



kW

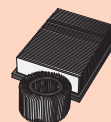
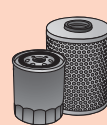

...SUZUKI

1300cc	GSX	R Hayabusa WVA1		1999 → 2006	K301		
	GSX	Hayabusa WVA1	129kW	2006 →	K301		
1400cc	GV			1987 → 1988	K301		
	GSX	WVBN	78kW	2002 → 2006	K301		
	VS	INTRUDER VX51L	49kW	1985 → 1994	K301		Y320
	VS	INTRUDER VX51L		1987 → 1998	K301 (Front Intake)		
	VS	INTRUDER VX51L		1987 → 1998	K301 (Back Intake)		Y320
	VS	INTRUDER VX51L		1999 → 2005	K301 (Back Intake)		Y320
1500cc	VL	Intruder LC WVAL		1998 → 2004	K301		
	VL	Intruder LC WVAL		2005 →	K301		
1600cc	VZ	Intruder VNT60B		2004 → 2005	K301		
1800cc	VZ	Intruder		2006 →	K301		

TRIUMPH

600cc	600 Daytona			2003 → 2004	F308		
	600 Speed Four			2001 → 2006	F308		
	600 TT			2000 → 2004	F308		
650cc	650 Daytona			2005 →	F308		
675cc	675 Daytona			2006 →	F308		
750cc	Speed Triple			1996 → 1999	X303		
	Daytona	20, 37, 66kW		1991 → 1998	X303		
	Trident	66kW		1991 → 1998	X303		
800cc	800 America			2002 → 2006	F308		
	800 Bonneville			2001 → 2006	F308		
	800 Bonneville	T100 (Centennial Edition)		2002 →	F308		
	800 Bonneville	T100		2003 → 2005	F308		
	800 Speedmaster			2003 → 2005	F308		
900cc	Bonneville Black			2007 →	F308		
	America			2007 →	F308		
	Scrambler			2006 →	F308		
	900 Bonneville	T100		2005 →	F308		
	900 Speedmaster			2004 →	F308		
	Thrupton			2004 → 2006	F308		
	Legend	TT		1999 → 2000	X303		
	Adventurer			1997 → 2001	X303		
	Daytona	Super III	72, 85kW	1994 → 1998	X303		
	Speed Triple		72kW	1994 → 1996	X303		
	Speed Triple	T 509	72kW	1997 → 2001	F301		
	Thunderbird			1995 → 2003	X303		
	Thunderbird	Klassik, sport	51kW	1995 → 2000	X303		
	Tiger		61kW	1991 → 2000	X303		
	Trident	Sprint	72kW	1991 → 2000	X303		
	Trophy		72kW	1991 → 2000	X303		
955cc	Daytona	T 595	72kW	1997 → 2000	F301		
	955i Daytona			1999 → 2006	F308		
	955i Speed Triple			1999 → 2005	F308		
	955 Sprint RS			2001 → 2004	F308		
	955 Sprint ST			2001 → 2004	F308		
	955 Tiger			2001 → 2006	F308		
1000cc	Daytona	Speed Triple	96kW	1996 → 2000	X303		
	Daytona		74kW	1991 → 1995	X303		
1050cc	1050 Speed Triple			2005 →	F308		
	1050 Sprint ST			2005 →	F308		
	Tiger			2007 →	F308		
1200cc	Tiger		72kW	1992 → 1998	X303		

TRIUMPH





kW

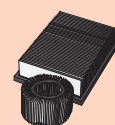
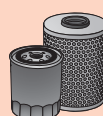

...TRIUMPH

...1200cc	Daytona	72kW	1993 → 1998	X303	
	Trophy	72kW	1991 → 1998	X303	
2300cc	Rocket III		2004 → 2005	F308	
	Rocket III Classic		2006 →	F308	

VOXAN

1000cc	Cafe Racer, Scrambler, Roadster		1998 →	X312	V301
---------------	---------------------------------	--	--------	-------------	-------------

YAMAHA

125cc	SR	SE 3MW	9kW	1997 → 2002	X313	
	TDR	4GW, 5AN	11kW	1992 → 2000	X302	
	TW	DE011	9kW	2000 → 2004	X313	
	XC	T, Beluga, Cygnus 4TH, 4UT	7kW	1994 → 2003	X313	
	XT	J, K, KC, L 2YE, 2YU		1982 → 1996	X313	
	XVS 125	Drag Star VP05	9kW	1999 → 2004	X302	
	XV	Virago 5AJ	8kW	1997 → 2001	X302	
150cc	XC 150	Flu One		1998 → 1999	X313	
180cc	XC	Cygnus 32H	10kW	1984 → 1988	X302	
200cc	AG	E, F 1FE		1993 → 1996	X313	
	BW	N, S, ES		1985 → 1988	X313	
	TW	E, EC, F,N, NC		1993 → 2004	X313	
225cc	XT 225	D, E, F, G		1992 → 2002	X313	
240cc	XV 240	Virago			X302	
250cc	SR	SE 3Y8	13kW	1980 → 1984	X302	
	SR	SP Classic		1991 → 2000	X302	
	TT			1980 → 1984	X302	
	TT	R, RF		1994 → 2002	X348	
	WR-F			2001 → 2002	X348	
	WR-F			2003 → 2006	X354	
	XG	TRICKER DG141	15kW	2005 →	X354	
	XT	4Y1	16kW	1982 → 1989	X302	
	XT	H, J, K, KC, L, LC, T, TL, TT 3Y3	13, 16kW	1982 → 1989	X302	
	XV	S Virago 3LS, W	13, 16kW	1989 → 2001	X302	
	XVS	DRAG STAR VG031	15kW	2001 → 2004	X302	
	YZ-F			2001 → 2002	X348	
	YZ-F			2003 → 2006	X354	
350cc	ATV	YFM WARRIOR		2002 →	X348	
	BW	T		1985 → 1987	X302	
	BW	U		1988 →	X313	
	RD	LC		1983 → 1986		Y303
	TT	E, F, T, 1TJ		1986 → 1993	X313	
	XT	3YT	13, 20kW	1991 → 1998	X313	
	XT	55V	23kW	1985 → 1991	X313	
	XT	59Y, 1WM		1985 → 1991	X313	
400cc	FZ	L		1992 → 1994	F306	
	FZR	RR 4DX		1987 → 1995	F306	
	SRX				X302	
	WR-F	F	27kW	1998 → 2001	X348	
	XJ	L, S Deversion			F306	
	XJR			1992 → 1998	X306	
	XS	2A2, 4A3		1980 → 1988	X306	
	XS	12E, 12F	20, 27, 45kW	1980 → 1988	X306	
	XS	SE 4G5	20, 33kW	1980 → 1988	X306	
	XT			1981 → 1986	X302	
	XV	SE, SP			X302	
	YP 400	Majesty SH025	25kW	2004 → 2006	X355	

YAMAHA



kW

21

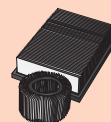
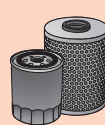

...YAMAHA

...400cc	YP 400	Majesty SH054		2006 →	X355		
	YZ-F	5GR		1998 → 1999	X348		
426cc	WR-F	CJ02		2001 → 2002	X348		
	YZ-F			2000 → 2004	X348		
450cc	WR	F, R, ST		2003 → 2006	X354		
	YZ-F	F		2003 → 2006	X354		
	YZ-F	R, ST		2003 → 2007	X354		
500cc	RD	LC 47X, 1GE	65kW	1983 → 1988			Y321
	SR	2J4, 4E6, 4F9	20kW	1980 → 1986	X302		
	SR	48T, 48U	20kW	1984 → 1992	X302		Y305
	SR	1RU, 3EB	17kW	1987 → 2000	X302		Y305
	TT	C, E, H		1978 → 1980	X302		
	XJ	4V8	37kW	1978 → 1983	X306		
	XS	E 1H2, 4V8	37, 43kW	1978 → 1983	X302		
	XT	4E5, 56U	38kW	1980 → 1990	X302		
	XT	3BH	20, 37kW	1988 → 1995	X302		Y306
	XT	Z 1E6, 1V6		1976 → 1989	X302		
	XT	E		1993 → 2000	X302		
	XP	T-MAX XP500	29kW	2000 → 2002	F307		Y324
	XP	A - T-MAX SJ034	32kW	2003 → 2006	F307		Y324
	XV	S, U, SE, Virago 1U6, 26R	36kW	1981 → 1986	X302		
535cc	XV	Virago 3BT, 2YL, 3BR	25, 34kW	1988 → 1997	X302		V305
	XV	DX, Virago VJ011, VJ012	25, 34kW	1997 → 2002	X302		
	XV	Virago FOR (CH) MODEL		1999 → 2001	X302		V305
	XV	S 4KU, 4MC	25, 34kW	1993 → 1997	X302		V305
550cc	XJ	4V8, 27A	37, 47kW	1980 → 1988	X306		
	XT	K, J 5Y3, 28E	17, 20kW	1980 → 1988	X302		Y305
	XZ	S 11U, 11V	37, 47kW	1980 → 1988	X302		
600cc	FZ6	RJ071, RJ074		2004 → 2006	F306		J329
	FZ6	FAZER RJ074, RJ076		2004 → 2006	F306		J329
	FZ6	FAZER S2, ABS RJ148		2007 →	F306		
	FZ6	FAZER S2 RJ149		2007 →	F306		
	FZR	F, G, H, J, N, M		1989 → 1994	F306		V303
	FZR	RJ021, RJ022		1989 → 1999	F307		Y327
	FZR	R 4JH, MH	25, 72kW	1994 → 1995	F306		V309
	FZS	Fazer 5 DM		1999 → 2003	F307		Y327
	FZS	S Fazer RJ025		2002 → 2003	F307		Y327
	SRX	1XL,M	20,33kW	1986 → 1991	X302		
	SRX	CH 1XN, 2TM		1985 → 1991	X302		
	TT	1XM	13, 32kW	1984 → 1990	X313		
	TT	E		1997 → 2000	X302		
	TT	E, R DJ011		1999 → 2003	X302		
	TT	R, RE DJ012		2004 → 2005	X302		
	XJ	51J, 51H		1984 → 1991	X306		J310
	XJ	N 4BR, 4DS		1992 → 1994	F306		V311
	XJ	N		1995 → 1997	F306		V311
	XJ	S Diversion 4BR, 3KN, RJ011		1992 → 2003	F306		V311
	XJ	N		1999 → 2001	F306		V311
	XT	43F, 49H, 3PW		1984 → 1991	X302		
	XT	N, H 2KF, 2NF, 3KF, 18J		1984 → 1991	X302		U304
	XT	Z Tenere 34L, 55W		1983 → 1985	X302		
	XT	Z Tenere 3AJ, 1VJ	20, 34, 36, 45kW	1986 → 1991	X302		
	XT	E, K, KN, KH 3TB, 3UW		1991 → 1995	X302		U304
	XT	3YP, 4AE		1990 → 1994	X302		U304

YAMAHA



kW

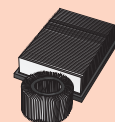
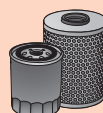

...YAMAHA

Capacity	Model	Year	kW	Filter Part	Filter Part	Filter Part
...600cc	XT	4PT, 4SK		1994 → 1996	X302	U304
	XT	4PT		1996 → 2003	X302	
	YZF	R Thundercat 4TV, 4WD	25, 72kW	1996 → 2000	F306	
	YZF	R Thundercat 4WD		2001 →	F306	
	YZF-R6	5EB, RJ05		1999 → 2002	F306	Y331
	YZF-R6	RJ031		2001 → 2002	F306	Y331
	YZF-R6	RJ032, RJ091		2003 → 2005	F306	
	YZF-R6	(R46) RJ111		2004 → 2007	F306	
	YZF-R6	S RJ095		2004 →	F306	
650cc	XJ	11N, 11R		1981 → 1989	X306	J300
	XJ	27G, 17F		1982 → 1990	X306	J300
	XJ	K,L,SK,SL 4KO	34, 52kW	1980 → 1988	X306	J300
	XJ	SP 4KO	52kW	1980 → 1988	X306	
	XJ	Turbo 11T	66kW	1981 → 1986	X306	
	XVS	4VR, 4XR		1998 → 2004	X302	V308
	XVS	Drag Star 4VR, 4XR		1997 → 2004	X302	V308
	XVS	A Drag Star VM041		2004 →	X302	V308
660cc	MT-03	RM021		2006 →	X302	
	SZR	4SU	25, 35kW	1996 → 2000	X302	
	XT	R, X DM011, DM014		2004 → 2006	X302	
	XTZ	Tenere 3YF	20, 25, 34kW	1989 → 1995	X302	J302
	XTZ	Tenere 4MY, 4NW		1994 → 1995	X302	J302
	XTZ	Tenere 4MY, 4NW		1996 → 1999	X302	
700cc	FZX	SC 1FN	68kW	1984 → 1988	X306	
	XJ	N, S 41Y	63kW	1982 → 1986	X306	
750cc	FZ	1FN, 1TV, 2KK	74kW	1984 → 1992	X303	X321
	FZ	P 3KT, 3DY	72kW	1987 → 1994	X303	X321
	FZR	3CV, 3JE	74kW	1986 → 1993	F306	V311
	FZR	R 3PJ, 3WM	37, 74kW	1989 → 1994	F306	V311
	FZR	RT, RU, Genesis 2KK		1987 → 1990	X303	X321
	FZX	2JE	70kW	1986 → 1990	X303	X321
	FZX	T 1UG	25kW	1986 → 1988	X303	X321
	XJ	Laguna Seca 11M	62kW	1982 → 1988	X306	J300
	XJ	RH 41Y	64kW	1983 → 1988	X306	J312
	XS	C, CT, D, E, T 1T5	51kW	1980 → 1988	X311	
	XS	SE 3L3	51kW	1980 → 1988	X311	
	XTZ	Super Tenere 3LD, 3WM	20, 25, 37, 51kW	1989 → 1995	X302	J327
	XV	SE 5K4, 5G5	45kW	1981 → 1988	X302	J319
	XV	SP 4FY	41kW	1994 → 1997	X302	J309
	XV	Virago 4FY, 4PW	20, 37, 40kW	1990 → 1999	X302	J309
	YZ-F	R,SP 4HN, 4HT	72, 74kW	1993 → 1998	F306	J318
	YZ-F	R7 RM011		1899 → 2001	F306	
850cc	TDM	H,N 3VD, 4TX		1991 → 2001	X302	V311
	TRX	4UN	25, 61kW	1996 → 2000	X302	
	XS	G, LG, SG, LH, H, SH 4E2	58kW	1980 → 1988	X311	
900cc	TDM	RM081, RM111		2002 → 2004	X302	J331
	TDM	A RM114		2005 →	X302	J331
	XJ	1FW, 31A, 42N, 58L	72, 75kW	1983 → 1993	X306	J312
	XJ	F 2HL, 3NG, 4BB	68, 72kW	1986 → 1996	X306	J312
	XJ 900 P	S Diversion 4KM	66kW	1994 → 2003	F306	V311
920cc	XV	RH 5A8	68kW	1981 → 1984	X306	

YAMAHA





kW

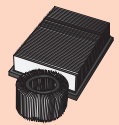
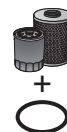
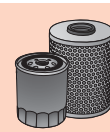

...YAMAHA

Capacity	Model	Power (kW)	Year Range	Filter Part	Filter Part	Filter Part	
1000cc	FZ1		2006 →	F306			
	FZ1		2006 →	F306			
	FZ1		2007 →	F306			
	FZR	2LA	74kW	1986 → 1988	X303	X321	V311
	FZR	3LE	72kW	1989 → 1990	X303	X321	V306
	FZR	3LE	72kW	1991 → 1994	F306		V306
	FZS	FAZER RN061, RN066		2001 → 2005	F306		
	FZS	FAZER RN141		2005 →	F306		
	GTS	A 4BH, 4FE	72kW	1993 → 2000	F306		
	TR1	(XV1000) 5A8	68kW	1981 → 1986	X302		J319
	XV	SE 3DR	37kW	1983 → 1989	X302		J309
	XV	SE 23W	37kW	1981 → 1986	X302		
	XV	Virago 19T	45kW	1982 → 1988	X302		J319
	XV	Virago 2AE	47kW	1986 → 1988	X302		J309
	YZF-R1	R,R1 5EP, RN012		1998 → 2000	F306		Y325
	YZF-R1	,R1 4VD5		2000 → 2001	F306		V306
	YZF-R1	,R1 RN091		2002 → 2003	F306		
	YZF-R1	R Thunder ACE 4VD, 4VS		1996 → 2002	F306		V306
	YZF-R1	R1 RN121		2004 →	F306		
	YZF-R1	R1, SP RN129		2006 →	F306		
1100cc	BT		2002 → 2004	X302		V311	
	BT		2005 →	X302		V311	
	FJ	2H9, 47E	68, 74kW	1983 → 1994	X303	X321	J311
	XS	2H9, 3X0	70kW	1980 → 1989	X311		
	XS	S 5K7	70kW	1980 → 1989	X311		
	XV	SP 3LP	68kW	1994 → 1998	X302		J309
	XV	Virago 3LP	20, 45kW	1989 → 2000	X302		J309
	XVS	DRAG STAR 5EL, VP052		1999 → 2002	X302		
	XVS	A DRAG STAR VP055		2000 → 2003	X302		
	XVS	A DRAG STAR Classic VP161		2004 →	X302		
1200cc	FJ	(A) 1XJ, 3CW, 3YA	72, 74kW	1984 → 1995	X303	X321	J311
	V Max	3LR, 2WE		1986 → 1995	X311		Y330
	V Max	3LR, 2WE		1996 → 1998	F306		Y330
	V Max	2EN		1999 → 2006	F306		Y330
	XJR	SP 4PU	72kW	1995 → 1999	X303	X321	
	XVZ	T 47G	73kW	1984 → 1987	X311		
1300cc	FJR	, A RP041, RP115		2001 → 2005	F306		
	FJR	A, AS RP131, RP135		2006 →	F306		
	XJR	5EA2, 3, 4		1999 → 2000	X303	X321	Y328
	XJR	RP022		2001 → 2004	X303	X321	Y328
	XJR	RP062		2002 → 2003	X303	X321	Y328
	XJR	RP102		2004 →	X303	X321	Y328
	XJR	RP191		2007 →	X303	X321	Y328
	XVZ	A Royal Star, DE 4NL, 4NK		1994 → 1998	F306		Y329
	XVZ	T 3JS	71, 72kW	1989 → 1992	X311		
	XVZ	TF ROYAL STAR VENTURE 4YP		1999 → 2006	F306		
	XVS	VP261		2007 →	F307		
1600cc	XV	WILD STAR 5JA5		1999 → 2004	F306		
	XV	WILD STAR VP081		2004 → 2006	F306		
1700cc	MT-01	RP121		2005 →	F306		
	XV	WARRIOR VP14E		2003 → 2005	F306		
1900cc	XV	MIDNIGHT STAR VP231		2006 →	F306		

YAMAHA



**21****AIXAM**

400cc	400	1997 → 2000	F306
	400 EVOLUTION	2000 → 2002	F306
	500 BERLINA	2002 →	F306
	500 MINIVAN	2002 →	F306
	500 PICK UP	2002 →	F306
	A721	2005 →	F306
	A741	2005 →	F306
	MEGA UTILITAIRE 400	2003 → 2005	F306
500cc	500	1998 → 2000	F306
	500 EVOLUTION	2000 → 2002	F306
	A751	2005 →	F306
	MEGA UTILITAIRE 500	2003 → 2005	F306

ARCTIC CAT

250cc	250 2x4	1999 → 2005	X328
	250 DVX Sport-Quad	2005 →	X328
300cc	300 4x4	1999 → 2005	X328
400cc	400 4x4	2004 →	K301
	400 4x4 Autom.	2005 →	K301
	400i 4x4 Sport	2004 →	X345
	400 TBX	2004 →	X345
	400 TVX	2004 → 2008	X345
500cc	500 4x4 Autom.	1999 → 2002	K301
	500 4x4, Autom.	2003 → 2004	K301
	500 TBX 4x4	2005 →	K301
	500 TRV 4x4	2005 →	K301
650cc	650 V2 4x4	2005 →	F308
	650 V2 4x4	2006 →	F308

BOMBARDIER

330cc	330 OUTLANDER	2004 →	X312
400cc	400 OUTLANDER MAX, XT	1999 → 2006	X312
500cc	500 TRAXTER ,XT, XL, MAX	1999 →	C322
	500 TRAXTER ,AUTO CVT	2005 →	X347
	500 QUEST	2003 → 2004	X347
650cc	DS 650 ,BAJA, X	2001 →	X312
	650 QUEST ,MAX, XT	2002 →	X347
	650 TRAXTER ,AUTO CVT, MAX	2005 →	X347
800cc	800 OUTLANDER 800, MAX	2006 →	X312

HONDA

200cc	TRX D	1990 → 1997	X356
250cc	TRX X, FOURTRAX	1985 → 1992	X356
300cc	TRX 2WD	1988 → 2001	X356
	TRX EX	1993 → 2002	X356
	TRX EX SPORTRAX	2003 → 2006	X356
	TRX 4WD FW FOURTRAX	1987 → 2001	X356
350cc	TRX D, FOURTRAX FOREMAN	1986 → 1989	X356
	TRX TM, FOURTRAX RANCHER	2000 → 2006	X356
	TRX TE, FOURTRAX RANCHER ES	2000 → 2006	X356
	TRX FE, FOURTRAX RANCHER ES4x4	2000 → 2006	X356
	TRX FE, FOURTRAX RANCHER 4x4	2000 → 2006	X356
	TRX EX, SPORTRAX	2002 →	X356

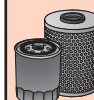
**21****...HONDA**

400cc	TRX FW, FOURTRAX FOREMAN	1995 → 2002	X356
	TRX EX	1999 → 2000	X356
	TRX EX SPORTRAX	2001 → 2006	X356
	TRX FA, FOURTRAX RANCHER AT	2004 → 2006	X304
	TRX FAG FOURTRAX RANCHER AT	2004 → 2006	X304
420cc	TRX TM Fourtrax Rancher	2007 → 2008	X356
	TRX FE Fourtrax Rancher 4x4	2007 → 2008	X356
	TRX TE FOURTRAX RANCHER ES	2007 → 2008	X356
	TRX FM FOURTRAX RANCHER ES 4x4	2007 → 2008	X356
450cc	TRX S/SE, FOURTRAX FOREMAN	1998 → 2002	X356
	TRX FM, FOURTRAX FOREMAN	2003 →	X356
	TRX FM, FOURTRAX FOREMAN S	2003 → 2004	X356
	TRX FE, FOURTRAX FOREMAN ES	2003 → 2004	X356
	TRX R	2004 →	X357
500cc	TRX FA, FGA FOURTRAX FOREMAN RUBICON	2000 →	X304
	TRX FA, FGA FOURTRAX FOREMAN 4x4 ES	2005 → 2006	X356
	TRX FM, TM, FOURTRAX FOREMAN 4x4	2005 → 2006	X356
650cc	TRX FA, FGA, FOURTRAX RINCON	2003 → 2005	X304
680cc	TRX FA-6, FGA-6, FOURTRAX RINCON	2006 →	X304

KAWASAKI

250cc	KLF250 KLF220 A1-A15 Bayou	1988 → 2002	X310
	KLF250 KLF250 A1-A3, A6F, A7F Bayou	2003 → 2007	X310
	KLF250 KSF250 A1-A4 Mojave	1987 → 1990	X310
	KSF250 KSF250 A5-A18 Mojave	1991 → 2004	X310
300cc	KEF300 KEF300 A1-A6 Lakota	1995 → 2000	X310
	KEF300 KEF300 B1-B3 Lakota	2001 → 2003	X310
	KLF300 KLF300 A1, A2 Bayou	1986 → 1987	X310
	KLF300 KLF300 C1-C16 Bayou	1989 → 2004	X310
	KLF300 KLF300 A8, A9 Bayou	1996 → 1997	X310
	KLF300 KLF300 B1-B17 Bayou	1988 → 2004	X310
	KVF300 KVF300 A1-A4, B1-B4 Prairie	1999 → 2002	F308
360cc	KVF360 KVF360 A1-A3, A6F, A7F Prairie 4x4	2003 → 2007	F308
	KVF360 KVF360 B1-B3, B6F, B7F Prairie	2003 → 2007	F308
	KVF360 KVF360 C1 Prairie Advantage Classic	2003 →	F308
	KVF360 KVF360 C2-C3, C6F, C7F Prairie 4x4 Hardwoods Green HD	2004 → 2007	F308
400cc	KFX400 KFX400 A1-A3, A6F (KSF400)	2005 → 2006	X345
	KLF400 KLF400 B1-B6 Bayou	1993 → 1998	F308
	KVF400 KVF400 A1-A3 Prairie	1997 → 2001	F308
	KVF400 KVF400 B1 Prairie	1998 →	F308
	KVF400 KVF400 C1-C4 Prairie	1999 → 2002	F308
	KVF400 KVF400 D1-D4 Prairie	1999 → 2002	F308
450cc	KAF450 KAF450 B1 MULE 1000		F308
540cc	KAF540 KAF540 C1 MULE 2010		F308
	KAF540 KAF540 D1 MULE 2020		F308
	KAF540 KAF540 E1 MULE 2030		F308

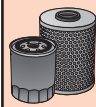
**21****...KAWASAKI**

650cc	KVF650	KVF650 A1-A2, B1-B2 Prairie	2002 → 2003	F308
	KVF650	KVF650 D1, D6F, D7F Brute Force 4x4	2005 → 2007	F308
	KVF650	KVF650 E1, E6F, D7F Brute Force 4x4 Realtree Hardwoods Green HD	2005 → 2007	F308
	KVF650	KVF650 F6F Brute Force 4x4i	2006 →	F308
	KVF650	KVF650 F7F Brute Force 4x4i	2007 →	F308
	KVF650	KVF650 G6F, G7F Brute Force 4x4i Realtree Hardwoods Green HD	2006 → 2007	F308
	700cc	KFX700	KFX700 A1-A2, B2 V Force (KSV700)	2004 → 2005
KFX700		KFX700 A6F, A7F, B6F, B7F, C6F (KSV700)	2006 → 2007	F308
KVF700		KVF700 A1-A2, A6F Prairie 4x4	2004 → 2006	F308
KVF700		KVF700 B1-B2 Prairie 4x4 Hardwoods Green HD	2004 → 2005	F308
KVF700		KVF700 D1, D6F Team Green Special Edition	2005 → 2006	F308
750cc	KVF750	KVF750 A1 Brute Force 4x4i	2005 →	F308
	KVF750	KVF750 A1 Brute Force 4x4i Realtree Hardwoods Green HD	2005 →	F308
	KVF750	KVF750 A6F, A7F, B6F, B7F, C6F, C7F Brute Force 4x4i	2006 → 2007	F308
	KVF750	KVF 750 E8A Brute Force 4x4i NRA Outdoors	2008 →	F308

POLARIS

300cc	300 Hawkeye 2x4		2007 →	F306
	300 Hawkeye 4x4		2007 →	F306
325cc	325 Magnum 2x4		2000 → 2002	F306
	325 Magnum 4x4		2000 → 2002	F306
	325 Trail Boss		2000 → 2002	F306
	325 Xpedition		2000 → 2002	F306
330cc	330 ATP		2004 → 2005	F306
	330 Hawkeye 2x4		2006 →	F306
	330 Hawkeye 4x4		2006 →	F306
	330 Magnum 2x4		2003 → 2005	F306
	330 Magnum 4x4		2003 → 2006	F306
	330 Magnum 4x4 Mossy Oak		2004 →	F306
	330 Trail Boss		2003 → 2007	F306
335cc	335 Sportsman		1999 → 2001	F306
	400cc	400 Sportsman 4x4	2001 → 2005	F306
400L Xplorer			1996 → 2001	F306
425cc	425 Magnum 2x4		1996 → 1998	F306
	425 Magnum 4x4		1995 → 1998	F306
	425 Magnum 6x6		1996 → 1997	F306
	425 Xpedition		2000 → 2002	F306
450cc	450 Sportsman		2006 → 2007	F306

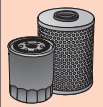
**21****...POLARIS**

500cc	500 ATP HO		2004 → 2005	F306
	500 Magnum		2000 → 2002	F306
	500 Outlaw		2007 →	X301
	500 Predator		2003 → 2007	X301
	500 Predator Troy Lee Edition		2005 → 2005	X301
	500 Ranger 2x4, 4x4, 4x4 EFI		2006 → 2007	F306
	500 Scrambler		2006 → 2007	F306
	500 Sportsman HO		2000 → 2006	F306
	500 Sportsman HO Mossy Oak		2004 → 2004	F306
	500 Sportsman EFI		2006 → 2007	F306
	500 Sportsman 6x6		2000 → 2007	F306
	500 Sportsman X2		2006 → 2007	F306
	500 Xplorer 4x4		1997 → 1997	F306
600cc	600 Sportsman Twin		2004 → 2006	F306
700cc	700 Ranger 6x6 EFI		2007 →	F306
	700 Sportsman Twin		2004 → 2006	F306
	700 Sportsman Twin EFI		2005 → 2007	F306
	700 Sportsman X2 Efi		2008 →	F306
800cc	800 Sportsman Twin		1995 → 2005	F306
	800 Sportsman EFI		2006 → 2007	F306
	800 Sportsman X2 EFI		2007 →	F306
	800 Ranger RZR		2008 →	F306

SUZUKI

90cc	LT-Z90	LT-Z90 K7 QuadSport	2007 →	X327
125cc	LT 125	LT 125 D, E, F, G, H	1993 → 1997	X327
	160cc	LT-F160	LT-F160 M, N, P, R, S, T, V, W	1991 → 1998
LT-F160		LT-F160 X, Y, K1, K2	1999 → 2002	X328
LT160		LT160 K3, K4 Quadrunner	2003 → 2004	X328
185cc	LT185	LT185 E, F, G, H	1984 → 1987	X327
	230cc	LT230	LT230 GEF, GEG	1985 → 1987
LT230		LT230 SF, SG, SH, SJ	1985 → 1988	X328
LT-F230		LT-F230 G, H	1986 → 1987	X328
LT230		LT230 E- H, J, K, L, M, N, P	1986 → 1993	X328
250cc	LT250	LT250 EF, EFF, EFG	1985 → 1986	X328
	LT-F250	LT-F250 J, K, L, M, N, P, R, S, T, V, W, X, Y, K1, K2 Quadrunner	1988 → 2002	X328
	LT-F250	LT-F250 K3, K4, K5, K6, K7 Ozark	2003 → 2007	X328
	LT-Z250	LT-Z250 K4, K5, K6, K7 QuadSport	2004 → 2007	X328
	LT 4WD	LT 4WD H, J, K, L, M, N, P, R, S, T, V, W, X	1987 → 1999	X328
	LT-F 4WD	LT-F 4WD X M, N, P, R, S, T, V, W King Quad	1991 → 1999	X328
300cc	LT300	LT300 EH, EJ, EK	1987 → 1989	X328
	LT-F300F	LT-F300F King Quad	2000 → 2002	X328

SUZUKI

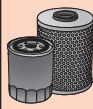
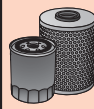
**21****21****...SUZUKI**

400cc	LT-F400	LT-F400 K2, K3, K4 Eiger 2x4	2002 → 2004	K301
	LT-A400	LT-A400 K2, K3, K4 Eiger 2x4 Automatic	2002 → 2004	K301
	LTF400 K	LTF400 K7 Eiger 2WD	2007 →	K301
	LT-F400F	LT-F400F-K2, K3, K4 Eiger 4x4	2002 → 2004	K301
	LT-A400F	LT-A400F-K2, K3, K4, K5, K6 Eiger 4x4 Automatic	2002 → 2007	K301
	LT-A400F	LT-A400F K7 Eiger 4x4 Automatic	2007 →	K301
	LT-F400FC	LT-F400FC-K4, K5, K6, K7 Eiger Automatic 4x4 Camouflage	2004 → 2007	K301
	LT-Z400	LT-Z400 K3, K4, K5, K6, K7 QuadSport	2003 → 2007	X345
450cc	LT-A450X	LT-A450X K7, K8 King Quad	2007 →	K301
	LT-R450	LT-R450 K6, K7 Quadracer	2006 → 2007	X345
500cc	LT-F500F	LT-F500F Quadrunner	1998 → 2002	K301
	LT-A500F	LT-A500F Quadrunner	1998 → 2002	K301
	LT-F500F	LT-F500F-K2, K3, K4, K5, K6 Vinson 4x4	2002 → 2006	K301
	LT-F500F	LT-F500F K7 Vinson 4x4 Camouflage	2007 →	K301
	LT-F500FC	LT-F500FC-K5, K6 Vinson 4x4 Manual Camouflage	2005 → 2006	K301
	LT-A500F	LT-A500F-K3, K4, K5, K6, K7 Vinson Automatic 4x4	2003 → 2007	K301
	LT-A500FB	LT-A500FB-K4, K5 inson Automatic 4x4	2004 → 2005	K301
	LT-A500FC	LT-A500FC-K4, K5, K6 Vinson Automatic 4x4 Camouflage	2004 → 2006	K301
700cc	LTA700 X	LTA700 X-K5, K6, K7 King Quad	2005 → 2007	K301
	LTV700 F	LTV700 F-K4, K5 Twin Peaks 4x4	2004 → 2005	F308

YAMAHA

200cc	YFM	YFM200 N	1985 → 1989	X313
	YFM	YFM200 DXS, DXW	1986 → 1987	X313
225cc	YFM	YFM225 S, T, U	1986 → 1990	X313
230cc	YFM	YFM230 BearTracker	2003 → 2004	X313
250cc	YFB	YFB250 D, G	1992 → 1995	X313
	YFB	YFB250 F, FWF, G, H, K, H, UH, UJ, UK Timberwolf	1994 → 1999	X313
	YFB	YFB250 FW Timberwolf	2000 →	X313
	YFM	YFM250 W	1989 → 1992	X313
	YFM	YFM250 ERW, ERA, D	1989 → 1993	X313
	YFM	YFM250 Bear Tracker	1991 → 2004	X313
	YFM	YFM250 Bruin	2006 →	X313
	350cc	YFM	YFM350 XT, XU Warrior	1987 → 1988
YFM		YFM350 ERT, ERU	1987 → 1988	X348
YFM		YFM350 FWT, FWU, FWW, FWF Big Bear	1987 → 1992	X348
YFM		YFM350 FWJ, UJ, FWBJ Big Bear	1997 → 1999	X348
YFM		YFM350 FW-A, B, D, E, F, G	1990 → 1995	X348
YFM		YFM350 UH	1996 →	X348
YFM		YFM350 BA-S, T, V Bruin Automatic 2WD	2004 → 2006	F306
YFM		YFM350 FA-S, T, V Bruin Automatic 4x4	2004 → 2006	F306

...YAMAHA

350cc	YFM	YFM350 FAH-T, V Bruin Hunter 4x4	2005 → 2006	F306	
	YFM	YFM350 FX-H, J, K, L, M, N, P, R, S, T Wolverine 4x4	1996 → 1995	X348	
	YFM	YFM350 FX-V Wolverine 2WD	2006 →	F306	
	YFM	YFM350 X- W, B, D, E, F, G, H, J, L, M, N, P, R, S Warrior	1989 → 1995	X348	
	YFM	YFM350 R-T, V Raptor	2005 → 2006	X348	
	YFM	YFM350 R-W Raptor	2007 →	X348	
	YFP	YFP350 T, U Terrapro	1988 →	X348	
	400cc	YFM	YFM400 FWF, FWG, FWH, FWK Kodiak	1994 → 1999	X348
YFM		YFM400 A Kodiak 400 Automatic	2000 → 2004	F306	
YFM		YFM400 FA Kodiak 400 Automatic 4x4	2003 → 2006	F306	
YFM		YFM400 Big Bear	1993 → 2002	X348	
YFM		YFM400 N, S Big Bear 2WD	2003 → 2004	X348	
YFM		YFM400 FW Big Bear 4x4	2003 → 2006	X348	
450cc		YFM	YFM450 FA Kodiak 450 4WD	2003 → 2006	F306
		YFM	YFM450 FAH Kodiak 450 4WD Hunter	2003 → 2005	F306
	YFM	YFM450 Wolverine 4x4	2006 →	F306	
	YFZ	YFZ450 S, T, V	2004 → 2006	X354	
	YXR	YXR450 Rhino Auto 4x4	2006 →	F306	
	600cc	YFM	YFM600 FWAQ Grizzly	1998 → 2001	X302
660cc	YFM	YFM660 R-N. P. R. S. T Raptor	2001 → 2005	F307	
	YFM	YFM660 RLE-R, S Raptor Black Limited Edition	2003 → 2004	F307	
	YFM	YFM660 F-P, R, S, T, V Grizzly 4x4 Automatic	2002 → 2006	F306	
	YFM	YFM660 FR-C Grizzly 660 Limited	2003 →	F306	
	YFM	YFM660 FHR Grizzly 660 4x4 Wetlands Hunter Edition	2003 →	F306	
	YFM	YFM660 FHS Grizzly 660 4x4 Hardwoods Hunter Camo	2004 →	F306	
	YFM	YFM660 FG-W Grizzly	2007 →	F306	
	YFM	YFM660 FGH-W Grizzly Hunter	2007 →	F306	
	YXR	YXR660 Rhino	2004 → 2006	F306	
	YXR	YXR660 Rhino Hardwood Camo	2004 → 2005	F306	
	YXR	YXR660 Rhino Exploring Edition	2006 →	F306	
	YXR	YXR660 Rhino Special Edition	2006 →	F306	
700cc	YFM	YFM700 FGH-W, X Grizzly Hunter Fi Auto 4x4	2007 → 2008	F306	
	YFM	YFM700 G Grizzly Fi Auto 4x4	2007 →	F306	
	YFM	YFM700 G Grizzly Fi Auto 4x4 Ducks Unlimited Edition	2007 →	F306	
	YFM	YFM700 G Grizzly Fi Auto 4x4 Outdoorsman Edition	2007 →	F306	
	YFM	YFM700 R-V, W Raptor	2006 → 2007	X302	

OE#



OE#

OE001	N9YC
OE004	RN9YCC
OE005	RC9YC
OE006	RN9YC
OE007	L87YC
OE008	RN7YCC
OE010	N7YC
OE013	RC12YC
OE014	RC7YCC
OE015	N12YC
OE017	C7YC
OE018	RN7YC
OE021	RC7BMC
OE022	N9YCC
OE023	C9YCC
OE026	RC8DMC
OE031	RES9YCC4
OE037	L86C
OE038	L82YC
OE039	RC9YC4
OE040	N2C
OE042	RN12YC
OE043	RC7YC
OE045	RN11YCC
OE048	RN9YC4
OE049	RN11YC4
OE051	RN11YC
OE052	RA4HCX
OE059	L92YC
OE060	RN9LCC
OE064	RL82YC
OE065	N11YC
OE068	N3C
OE073	RA4HC
OE074	N5C
OE075	C6YCC
OE077	RC7BYC4
OE078	N3G
OE079	N4C
OE083	RA6HC
OE084	N6YCC
OE086	RL82C
OE087	N6YC
OE091	RN2C
OE092	RG4HC
OE094	RC6YCC
OE098	RN4C
OE103	A59GC
OE108	RN3C
OE109	N6BYC
OE112	A6GC
OE116	RN6YC
OE122	RG4PHP
OE125	N2G
OE132	A6HC
OE156	RN13LYC
OE179	RC8WYP4

A59GC	OE103
A6GC	OE112
A6HC	OE132
C6YCC	OE075
C7YC	OE017
C9YCC	OE023
L82YC	OE038
L86C	OE037
L87YC	OE007
L92YC	OE059
N11YC	OE065
N12YC	OE015
N2C	OE040
N2G	OE125
N3C	OE068
N3G	OE078
N4C	OE079
N5C	OE074
N6BYC	OE109
N6YC	OE087
N6YCC	OE084
N7YC	OE010
N9YC	OE001
N9YCC	OE022
RA4HC	OE073
RA4HCX	OE052
RA6HC	OE083
RC12YC	OE013
RC6YCC	OE094
RC7BMC	OE021
RC7BYC4	OE077
RC7YC	OE043
RC7YCC	OE014
RC8DMC	OE026
RC8WYP4	OE179
RC9YC	OE005
RC9YC4	OE039
RES9YCC4	OE031
RG4HC	OE092
RG4PHP	OE122
RL82C	OE086
RL82YC	OE064
RN11YC	OE051
RN11YC4	OE049
RN11YCC	OE045
RN12YC	OE042
RN13LYC	OE156
RN2C	OE091
RN3C	OE108
RN4C	OE098
RN6YC	OE116
RN7YC	OE018
RN7YCC	OE008
RN9LCC	OE060
RN9YC	OE006
RN9YC4	OE048
RN9YCC	OE004

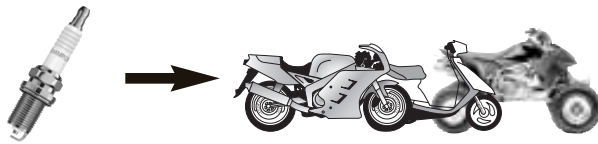

A6GC (OE112)

HONDA 500
JAWA/CZ 500

A6HC (OE132)

CAGIVA 500
HONDA 650
KEEWAY 150
KREIDLER 125
REX 125
YAMAHA 200

A59C

DUCATI 851
SUZUKI 750, 1100

A59GC (OE103)

BIMOTA 50, 1100
DUCATI 850, 888
GBM 992

C6YCC (OE075)

BETA 250
CAGIVA 600
FANTIC 210, 212, 250

C7YC (OE017)

FANTIC 250

C9YCC (OE023)

SCORPA 250

C53CX

MORBIDELLI 125

C55

BETA
HIRO MOTORI 250
MAICO 685
ROYAL ENFIELD 250
SVM 125

C55CX

APRILIA 125
GILERA 125
GREEVES

C55R

DOT 175
GILERA 50, 125
GREEVES
HONDA 80
JAWA/CZ 500
LAVERDA 750
MTK 1000
SUZUKI 175
TAU MOTORI

C57

CLIPIC 50
KTM 500
MOTO GEROSA 50

C57YC

GILERA 98

C59R

AMC 500
FANTIC 50, 125

C61

GAS GAS 200, 250, 300

C63YC

VOXAN 996

CJ6

ALGAT

CJ7Y

E-TON 40

CJ8

MSA 50

CJ8Y

SV 35

CJ14

ARGO
JOHN DEERE
KAWASAKI 620

D6

ARGO 399
PRAIRIE BOBCAT 295
SIERRA
STARCRAFT
SUNBEAM

D9

ALSPORT 395, 440
AMPHICAT 225, 280, 290
ARGO 440
ATEX
COOT
HUSTLER
MAX 297
RUPPSTER
SPD
TERRA-TIGER

D14

ATEX
BMW 736
GÖRICKE 50
HARLEY DAVIDSON 750, 1000, 1200, 1300
HEINKEL 150

D16

ARIEL 500

G54V

APRILIA 1000
HUSQVARNA 570, 630
MV AGUSTA 1000

G55C

CCM 500

G55R

GM 500
JAWA/CZ 500
SUZUKI 250
WESLAKE 500

G57C

BIMOTA 600
YAMAHA 600

G57R

GM 500
GODDEN 500
JAWA/CZ 500
WESLAKE 500
YAMAHA 750

G59C

BIMOTA 50
HONDA 50
HUSABERG 400, 499, 500, 501, 600
HUSQVARNA 350, 400, 410, 510, 577, 580, 610
KAWASAKI 1100
MBK 125
MINARELLI 50, 125
NORTON 588

G63

CCM 500
TRIUMPH 750

H8C

HARLEY DAVIDSON 900, 1000

J4C

ALSPORT-STEEN 80, 100
CHIBI
CUSHMAN
INDIAN 100
TRACKSTER

J8C

PEUGEOT 100

J12YC

HARLEY DAVIDSON 1000, 1200

L77JC4

AMC 150, 175, 250
AMERICAN EAGLE 175, 250
BULTACO 100
CASAL 50
FANTIC 75
GARELLI 80
HERKULES 80
JAWA/CZ 360
KAWASAKI 175, 250, 350, 400, 500, 750
KREIDLER 50
KTM 80, 100, 250, 400
MAICO 50, 125, 175, 250, 277, 350, 360, 400
MALANCA 125
MOTORI MORINI FRANCO 50
PUCH 50, 80
SUZUKI 250
YAMAHA 180
ZUNDAPP 125

L78C

ADLER 100, 125, 150, 250
AGS 125
AMC 250
BATAVUS 50
BETA 125
BMW 250, 600
BULTACO 75
CAGIVA 50
CAPRI 125
CASAL 50
CYRUS 50, 73
DAELIM 50
DERBI 50
DKW 48, 50, 125
DUCATI 250
DÜRRKOPP 171
ENDRESS 50
FAMEL 50
FANTIC 50, 75
FLANDRIA 50
GARELLI 50
GAS GAS 50

...L78C

GIULIETTA PERIPOLI 50
HEINKEL
HERKULES 50, 80, 100, 125
HM RACING 50
HONDA 50, 100
HUSQVARNA 50
INDIAN 70, 75
JAWA/CZ 50, 90, 125, 175, 250, 350
KAWASAKI 90, 100, 125, 250, 400
KTM 50, 80, 125, 175
KYMCO 50
LEM 50
MAICO 125, 250, 400
MALAGUTI 50
MARS 50
MBK 50, 75, 125
MINARELLI 50
MONARK 125
MONDIAL 50
MONTESA 250
MOTOBECANE (MBK/Yamaha) 125
MOTORI MORINI FRANCO 125
MZ 125, 150, 175, 250, 301
NSU 125, 200, 250, 500
PENTON 100, 125
PEUGEOT 50
PIAGGIO / VESPA 50, 80, 125
PUCH 50
RIXE 50
SACHS 50, 80, 100, 125
SANYANG 50
SIMONINI IMEA 50
SIMSON 50, 80
SIS 50
STARFLITE 50
SUZUKI 50, 60, 75, 90, 100, 120, 125, 200, 250, 300, 500
TEMPO 50, 100
TESTI 50, 80
TOMOS 49, 50, 90
VELOCIFERO 50
YAMAHA 50, 80, 90, 100, 125, 200, 250, 350
ZUNDAPP 50, 75, 100, 125

L78YC

APRILIA 50
DERBI 50

L82C

ADLER 200, 250
ARIEL 350, 500, 650, 1000
ATALA 50
AWO 425
BENELLI 50, 125
BMW 494, 500
BOOM TRIKE 1600
BSA 250, 350, 500
BULTACO 75
CAGIVA 50
CARREFOUR 50
CASAL 50
CLIPIC 50
DERBI 50
DKW 48, 50, 175
DUCATI 100, 125, 175, 250, 350, 450, 500
DÜRRKOPP 150, 175, 194, 200
FANTIC 125, 200, 210
G.A.C. MobyLe. 50
GÖRICKE 50
HEINKEL 175
HUSQVARNA 50
INDIAN 50
ITALJET 50, 125
JAWA/CZ 48, 125, 175

**...L82C**

KAWASAKI 90, 100, 250
 KREIDLER 50
 KTM 50
 LEM 50
 MAICO 150, 175, 200
 MALAGUTI 50
 MBK 49, 50, 80, 125
 MONDIAL 50, 125
 MONTESA 50
 MOTO MORINI 49, 50
 MOTOR HISPANIA 50
 MOTORI MORINI FRANCO 49
 MZ 50, 70, 125, 150, 250
 NEVAL 649, 650
 NORTON 500
 NSU 125, 175, 200, 350, 500
 PEUGEOT 50, 150, 155, 175, 250
 PIAGGIO / VESPA 75, 125, 190
 PUCH 50, 125
 RIEJU 50
 RIXE 50
 RIZZATO 50
 ROYAL ENFIELD 197, 250, 350
 SACHS 50, 80
 SIMONINI IMEA 50
 SIMSON 50, 51, 53, 70, 80, 83
 SIS 50
 SUZUKI 50, 125, 185
 TOMOS 50, 80
 TORPADO 50
 TORROT 50
 TRIUMPH 650
 URAL 750
 YAMAHA 80, 100, 125
 ZUNDAPP 50

L82YC**(OE038)**

BIMOTA 750
 BLANEY 79, 90, 100
 CCF 50, 100
 DERBI 50
 DINLI 100
 DNEPR 650
 DUCATI 750, 864, 900
 ERING 50
 HERKULES 50
 HYOSUNG 50, 100
 ITALJET 50, 125
 ITTECO 50
 IZH 347
 KINETIC 50, 80
 KTM 50
 MALAGUTI 50
 MBK 50
 MINARELLI 50
 MINSK 125
 MOTOTECHNIKA 50
 PGO 50, 75, 80, 125
 PUCH 80
 SACHS 50
 SUZUKI 50
 TGM 50
 TRAILBLAZER 50, 90
 URAL AMERICA 650
 WINKING 50
 YAMAHA 50
 YERF-DOG 90

L86C**(OE037)**

ALKRO 48
 ALL STATE
 AMC 100, 125
 ANKER
 ASPES 50

...L86C**(OE037)**

AT MOTO 50
 ATALA 50
 BAJAJ 50
 BATAVUS 50
 BENELLI 50
 BETA 50
 BM 49
 BMW 192, 305, 500, 600, 736, 745
 BOOM TRIKE 1600
 BSA 50
 BULTACO 50, 75, 100, 125, 150, 175
 CAPRI 50, 70, 80, 98, 125, 150
 CARABELA 60, 100
 CASAL 50
 CAZENAVE VAP PALOMA 50, 200
 CCM 500, 550, 580
 CECCATO 49, 175
 CHIORDA 50
 CIMATTI 50, 100, 150
 COSSACK , 350, 650
 DEMM 49, 125
 DERBI 49, 50, 75
 DKW 50, 200
 DOT 50
 DUCATI 125, 160, 175, 200, 250, 350, 500, 860, 864
 DUCSON 50
 DÜRRKOPP 47
 EMW 350
 ERING 50
 FANTIC 50, 125, 160
 FLANDRIA 50
 FN , 125
 FUCHS
 G.A.C. MobyLe. 50
 GARELLI 25, 35, 50
 GAZELLE 35
 GILERA 50
 GIMSON 50
 GITANE 50, 80, 125
 GIULIETTA PERIPOLI 50
 GÖRICKE 50, 500
 GUILER
 HARLEY DAVIDSON 80
 HELKAMA
 HERKULES 50, 100, 175
 HMW 50
 ILO ROCKWELL 48, 50
 INDIAN 50
 INTRAMOTOR GLORIA 50
 ITALJET 50, 100
 JAWA/CZ 49, 50, 125, 175, 250, 350
 JLO 50
 JOHN DEERE
 KAWASAKI 125
 KIEFT 50
 KREIDLER 50
 KTM 50, 125
 KYMCO 50
 LAMBRETTA 50
 LAURA MOTOREN 50
 LAVALETTE
 LAVERDA 60
 LEM 50
 LEOPARD
 MAICO 50, 125, 150, 175, 200, 250, 277, 400
 MALAGUTI 50
 MALANCA 50
 MANUFRANCE
 MARS 25, 50
 MBK 49, 50, 80
 MECATECNO 50
 MERLIN 50, 410
 MINARELLI 50

...L86C**(OE037)**

MONARK 125
 MONTESA 50, 125, 175, 250
 MOTO BM 49
 MOTO GEROSA 50
 MOTO GUZZI 50, 75, 110
 MOTO MORINI 49, 80
 MOTO VESPA 75, 125, 150
 MOTOBECANE (MBK/Yamaha) 49
 MOTOBICI (-> Benelli) 49
 MOTOBIC 49
 MOTOR HISPANIA 50
 MOTORI MORINI FRANCO 49, 50, 80
 MTK 50
 MZ 50
 NSU 50, 150, 175, 250
 OGLAND 500
 OMER 50
 OSSA 50
 PEUGEOT 50, 100, 125
 PEUGEOT MOVESA 50
 PIAGGIO / VESPA 25, 50, 80, 125, 150, 175, 180
 PLANET
 POLINI 50
 PROMOT 125
 PUCH 49, 50, 125
 RABBIT 49
 RCA 350
 REGENT 125, 175
 REX 50
 RIEJU 50, 75
 RIXE 50
 RIZZATO 50, 125
 ROYAL ENFIELD 50, 125, 250, 350, 500, 700
 SACHS 50
 SAROLEA 350
 SCO
 SEMIAC
 SIMONINI IMEA 50
 SIS 50
 SOLIFER 50
 SOLO 50
 SPARTA 50
 STARFLITE 50
 SUZUKI 50, 90
 SVM 50
 TAARNBY
 TECNOMOTO 50
 TESTI 50
 TGM 50
 TOKAIDO 25
 TOMOS 49
 TORPADO 50
 TOYOTA
 TRIMAK 50
 TUNTURI 50
 VAP
 VELOSOLEX 49
 VICOPED
 VILLIERS 122, 246, 249
 WINKING 50
 YAMAHA 50, 80
 ZANELLA 50
 ZUNDAPP 50

L87YC**(OE007)**

ADLY 50
 BAJAJ 125
 BOSS 90, 155
 BUFFALO 50
 CAGIVA 50
 DRR 50, 90
 DUCATI 350
 GARELLI 50

...L87YC**(OE007)**

HERKULES 125
 HMZ 50
 HYOSUNG 50, 100
 IZH 346, 347
 KUANG YANG 50
 LECSON 50
 MARS 50
 MINARELLI 50
 MONTESA 50, 75
 MOTOTECHNIKA 45, 50, 200
 MZ 50, 100
 PEUGEOT 125
 PGO 50
 QINGQI 50
 SACHS 50, 125
 SHE LUNG 50
 STEFFEN 50
 SUZUKI 50, 75, 90, 100
 TGB 49, 50
 TNG 50
 TOKAIDO 50
 VELOCETTE 350
 VIVA 50
 WINKING 50
 YAMAHA 50, 60, 75, 80, 100
 ZID 175, 197, 200
 ZONGSHEN 50
 ZUNDAPP 600, 601

L90C

JAWA/CZ 50
 PUCH 50
 RIXE 50
 ROYAL ENFIELD 150

L92YC**(OE059)**

BAJAJ 100, 145, 150, 173
 CARABELA 50
 DERBI 75
 DNEPR 649
 HONDA 50, 75
 IMPULS 50
 KTM 50
 PGO 50
 SACHS 50
 SUZUKI 50
 URAL 648, 650
 YAMAHA 50
 ZUNDAPP 50

N1C

BETA 50
 FANTIC 125
 GILERA 50

N2C**(OE040)**

ACCOSSATO 80
 ALFER 80, 125, 250, 490
 APRILIA 50
 AVIAN 125
 BELGARDA 125
 BENELLI 50
 BETA 125
 BLATA 40
 BMW 600
 BULTACO 50, 125, 175, 200, 250, 350, 360, 370
 CAGIVA 50, 125, 500
 CCM 125, 250, 350, 490
 CLIPIC 80
 DERBI 50, 100, 125
 FAMEL 50
 FANTIC 50
 GAS GAS 125, 200, 250, 300, 330
 GILERA 50, 125

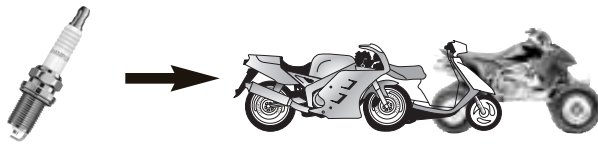

...N2C (OE040)

GRECAV 50
HERKULES 125
HUSQVARNA 50, 125, 390, 400, 430
INDIAN 50
ITALJET 180
JAWA/CZ 500
KAWASAKI 80, 125
KRAMER 250
KTM 500, 540
LEM 50
MAICO 125, 250, 440, 450, 490, 500
MALAGUTI 125
MBK 50
MECATECNO 50
MONTESA 250
MOTO KOSMOS 100, 125, 250
OSSA 125, 175, 250
PIAGGIO / VESPA 50, 75, 80, 125, 150
PUCH 80, 125, 175, 250, 350
ROYAL ENFIELD 100
SACHS 50, 125, 175, 250
SUNDIRO 50, 80
SUZUKI 175, 250, 370, 750
TM 80, 125, 250, 300
YAMAHA 80, 125, 175, 360
ZUNDAPP 50, 80

N2G (OE125)

BLATA 40
HUSQVARNA 125, 250, 260
KAWASAKI 80, 250
KTM 50, 80, 85, 125, 250, 300, 350, 390, 420, 440, 495, 500, 540
LEM 50
OSSA 250
PUCH 500
RIEJU 75, 80
SACHS 125, 350
SIMONINI IMEA 50, 125, 250
SUZUKI 125, 175, 250
VALENTI 80
YAMAHA 250, 750

N3C (OE068)

ALFER 125, 250, 300
AMC 500, 750
AVIAN 250
BAJAJ 100
BSA 125, 175, 250, 500, 650, 750
BULTACO 200, 250, 350, 360, 370, 450
CAPRI 50
CARABELA 100, 125, 175, 200, 250, 360, 400, 450
CASAL 50
CCM 250, 450
DERBI 50, 80
FANTIC 50, 74
G.A.C. MobyLe. 50
GAS GAS 250
GILERA 125
HARLEY DAVIDSON 50
HM RACING 50
INDIAN 80, 125, 175, 200
KAWASAKI 80, 90
MALAGUTI 50, 80, 125
MBK 49, 125, 250, 350
MONTESA 50
MOTO GEROSA 50
MOTO GUZZI 650, 750
MOTO KOSMOS 125, 250, 350, 500
MV AGUSTA 350, 600, 750
OSSA 150, 175, 230, 350, 500
PEUGEOT 50, 100
PIAGGIO / VESPA 50, 125

...N3C (OE068)

PUCH 125, 250, 366
RIZZATO 80
ROYAL ENFIELD 500
SUZUKI 100, 175, 250, 1000
TESTI 125
TRIUMPH 650, 750
YAMAHA 80, 100, 175
ZUNDAPP 175, 350

N3G (OE078)

FANTIC 160, 175, 250, 260, 300, 330
GAS GAS 125
HONDA 480
HUSQVARNA 250, 360
KAWASAKI 250
MAICO 610
SUZUKI 175, 185, 200, 250, 380, 400, 425, 465, 495
TRIUMPH 650, 750
YAMAHA 125

N4C (OE079)

AMC 350, 500, 750
ARIEL 250, 350, 500
BETA 240
BSA 175, 350, 440, 500, 650
BULTACO 200
CAPRI 50
CARABELA 100, 125, 450
HONDA 250
KAWASAKI 80, 175
LAMBRETTA 125, 150, 200
MALAGUTI 75
MONDIAL 50
MOTO GUZZI 350
MV AGUSTA 750, 800, 900
OSSA 160
RIEJU 50, 75, 80
ROYAL ENFIELD 750
SACHS 50
SUZUKI 80
TRIUMPH 650
YAMAHA 100, 250, 750

N5C (OE074)

ACCOSSATO 50
APRILIA 50
ARIEL 500, 600, 1000
BENELLI 50
BETA 50
BSA 50, 350, 600
CARABELA 100, 125, 175, 200, 400, 450
CCM 350
GILERA 50
LEM 50
LML- VESPA 200
MOTO GEROSA 50
MOTO MORINI 175
MOTOR HISPANIA 50
MOTORI MORINI FRANCO 175
NORTON 500, 600
PEUGEOT 175
RIEJU 50, 75
ROYAL ENFIELD 350, 500, 700
TESTI 50
TRIUMPH 750

N6BYC (OE109)

PIAGGIO / VESPA 50

N6YC (OE087)

BMW 900
KAWASAKI 80
LML- VESPA 125, 150
MÜNCH 1000, 1200
OSSA 125
PIAGGIO / VESPA 25, 50
ROYAL ENFIELD 350, 500
SUZUKI 50, 125
YAMAHA 650, 920

N6YCC (OE084)

FANTIC 212, 249, 250, 300
MOTO GUZZI 350, 400, 500, 650, 1000
NORTON 745, 750
SUZUKI 50, 80
YAMAHA 125, 135

N7YC (OE010)

BETA 50, 125, 250
BMW 475, 500, 600, 750, 800, 990
JCM 240, 333
LAVERDA 750
NORTON 650, 750, 850
SANGLAS 400
SUZUKI 80, 185
YAMAHA 150, 175, 250, 500, 650, 700, 850
ZUNDAPP 50

N9YC (OE001)

BMW 650, 800
BULTACO 125, 175, 250, 350
CARTER
DNEPR 650
GAS GAS 125, 240, 320
JCM 125
KTM 50
LEM 50
MBK 49, 50
MOTO GUZZI 750, 850, 1000
MOTO SPEZIAL 1100
MTV 50
OMER 50
OSSA 230, 250, 350
SANGLAS 350, 400, 500
SCORPA 250, 280
SHERCO 125, 250
SUZUKI 200
URAL 650
YAMAHA 125, 360, 1100
ZUNDAPP 50

N9YCC (OE022)

MONTESA 310, 311
MOTO GUZZI 700
MOTO MORINI 80

N11YC (OE065)

APRILIA 240
GAS GAS 143, 238, 240, 250, 272, 330
HARLEY DAVIDSON 65

N12YC (OE015)

APRILIA 125, 280, 320
BOOM TRIKE 1600
CCM 240, 250, 310, 320, 350
DUCATI 350
HIRO MOTORI 320
ITALJET 250, 350
SWM 125, 200, 240, 250, 320, 350

P7

HONDA 90, 125, 175, 200

P8Y

HONDA 90
P-RA7HC
ARCTIC CAT 246, 250, 300
BETA 125, 150
BMW 750, 990, 1000, 1100
ERING 250
FYM 125, 150
GUANRI 125, 150
HONDA 125, 250, 400, 450, 500, 550, 700, 750, 800, 1100, 1500
KAWASAKI 160, 400, 750, 1500
KYMCO 125, 150, 250, 300
PEUGEOT 250
PIAGGIO / VESPA 250
QINGQI 125, 150
SANLG 125, 150
SUZUKI 125, 160, 185, 230, 250, 280, 800, 1400, 1500
SYM 125
TIANYI 125, 150
YAMAHA 185, 200, 225, 230, 250, 400, 550, 600, 650, 1300, 1600, 1670

P-RG7C

GUANRI
QINGQI
SANLG
TIANYI

P-RZ9HC

BAJAJ 111
FYM , 50, 110
HONDA 50, 70, 90, 100, 125, 250
KAWASAKI 50
KEEWAY 250
KYMCO , 50, 110
MBK 125
MIDWEST 50, 70, 90
PANDA 50, 80, 125
QINGQI 139
SACHS 125
SUZUKI 50, 80, 90, 100, 111
SYM 50
YAMAHA 90, 125, 240, 250

QA55V

DUCATI 550, 748, 851, 888, 916, 950, 996

QC57

ATK 50
FRIGERIO MOTO 80, 125, 250, 350, 400, 496
HIRO MOTORI 125
KAWASAKI 80, 85, 100, 125
MOTO VILLA 125, 250, 500
SVM 250

QC57C

HONDA 350
MAICO 250
PEUGEOT 50
SUZUKI 80

QC59C

AMERICAN EAGLE 360, 405
MAICO 250, 320, 360, 380, 440, 500, 640
YAMAHA 200

QC59YC

HONDA 450, 650, 1000
MONDIAL 1000

**QL55**

DOT 197
 DUCATI 125, 250
 GREEVES
 HODAKA 100
 JAWA/CZ 125, 250, 350, 360, 400
 KTM 125
 MAICO 125
 MONDIAL 125, 175
 MOTORI MORINI FRANCO 50
 PUCH 75
 TEMPO 50, 100

QL77JC4

FANTIC 50
 GARELLI 50
 MBK 50
 YAMAHA 50

QL78C

ALSPORT 171, 400, 634
 DERBI 50
 HERKULES 80
 HONDA 50, 80
 HUSTLER
 MALAGUTI 50
 MBK 50
 SUZUKI 50
 TOKOYA 50, 80, 125
 TWIST-N-GO 49
 YAMAHA 50, 80, 100, 500

QN19V

PRAIRIE BOBCAT 440

QN84

APRILIA 50, 125, 250, 320
 ARM 125
 ASPES 125
 BENELLI 125
 BETA 125, 250, 350, 500
 CAGIVA 50, 125, 250, 500
 CCM 125, 250
 DERBI 75, 125, 250
 FANTIC 50, 80, 125
 GAS GAS 75, 125, 250
 GILERA 75, 125, 200, 250
 HARLEY DAVIDSON 250, 350
 HERKULES 50, 125, 175, 250, 350
 HONDA 125, 250
 HUSQVARNA 125, 240, 250, 360
 ITALJET 50, 80
 KAWASAKI 65, 125, 250
 KTM 60, 65, 85, 105, 125, 273, 390, 420, 495
 MAICO 500
 MALAGUTI 50
 MINARELLI 50, 75, 80, 125
 MONTESA 125, 414
 MOTO MORINI 49
 MOTORI MORINI FRANCO 50
 PIAGGIO / VESPA 50
 PUCH 350
 SUZUKI 125, 175, 250, 500
 SVM 50
 SWM 50, 125, 175, 250, 350, 370, 400
 TAU MOTORI
 TECNOMOTO 50
 TGM 50, 125, 250
 YAMAHA 80, 85, 90, 100, 125, 175, 250, 350, 490, 500

QN86

GAS GAS 50, 125, 250, 350
 HONDA 500
 HUSQVARNA 400
 KAWASAKI 250
 KTM 50, 65, 125, 250, 300, 360, 380
 MONTESA 350, 414
 SUZUKI 125, 250
 YAMAHA 80, 125, 175, 250

RA2HC

BIMOTA 750
 HONDA 100, 125, 600, 650
 KAWASAKI 400, 500, 550, 600, 900, 1000
 SUZUKI 350, 400, 500, 550, 600, 650, 750, 800, 1000

RA4HC (OE073)

APRILIA 1000
 BIMOTA 650, 851
 BMW 800
 BUELL 984, 1000, 1200
 CAGIVA 350, 900
 CAN-AM 998
 DERBI 125
 DUCATI 600, 620, 695, 750, 800, 906, 907, 916, 944, 996, 998
 E-ATV 625
 HARLEY DAVIDSON 1130, 1250
 HONDA 90, 100, 110, 125, 135, 145, 185, 200, 250, 350, 400, 450, 500, 600, 700, 750
 KAWASAKI 160, 250, 305, 400, 500, 550, 650, 750, 1200
 KTM 50
 LAVERDA 650, 668, 700, 750
 MOTO GUZZI 1250
 PIAGGIO / VESPA 50
 SUZUKI 100, 125, 200, 250, 300, 370, 400, 450, 500, 550, 600, 650, 700, 750, 850
 VYRUS 992
 YAMAHA 125, 400, 500, 600, 660

RA4HCX (OE052)

BIMOTA 1000
 BMW 1100, 1150, 1200
 BUELL 984, 1200

RA6HC (OE083)

AJP 125, 200
 APRILIA 250, 300, 350, 600, 650
 ATK 125, 348, 494, 500, 560, 600
 BAROSSA MOTOR 150, 170, 250
 BENELLI 250, 350, 500, 650, 750, 900
 BETA 125, 200
 BIMOTA 750, 900, 904, 906, 1000, 1150, 1200
 BMW 650, 1200
 BOMBARDIER 330, 400, 500, 650
 BSM 125
 CAGIVA 350, 500, 900, 904
 CARREFOUR 125
 CCM 500, 560, 600, 636
 CR & S 650
 DAREN 125, 150
 DAZON 175
 DERBI 170
 DUCATI 400, 600, 748, 750, 900, 904, 992, 1000, 1100
 EAR RACING 510, 625, 992
 E-ATV 510, 992
 FRIGERIO MOTO 350, 500
 GAS GAS 500
 GILERA 125, 600
 HERKULES 300
 HESKETH 1000
 HMZ 125

...RA6HC (OE083)

HONDA 110, 125, 150, 175, 185, 200, 250, 300, 350, 400, 450, 500, 550, 600, 650, 680, 700, 750, 900, 1000, 1050, 1100, 1200, 1300
 HUSABERG 400, 450, 470, 500, 501, 550, 650
 HUSQVARNA 500, 510
 HYOSUNG 125
 ITALJET 250, 350
 JAWA/CZ 125, 650
 JINCHENG 125
 JOHN DEERE 500, 650
 KARCHER 170
 KAWASAKI 50, 220, 250, 300, 305, 360, 400, 450, 500, 550, 600, 650, 700, 750, 900, 1000, 1200, 1500
 KEEWAY 125
 KREIDLER 125, 170
 KTM 125, 250, 350, 400, 450, 500, 510, 520, 525, 540, 565, 600, 609, 612, 620, 625, 640, 650, 654, 1000
 KYMCO 125, 150
 K-ZWO 125
 LAVERDA 350, 500, 600
 LINHAI 260
 MALAGUTI 250
 MANCO 260
 MBK 125, 250, 300
 MERLIN 452, 500
 METEORIT / ATU 125
 MIDWEST 125, 150, 200
 MOTO GUZZI 250, 350, 400, 1100
 MOTOR TEK 175
 MZ 500
 NORTON 650
 PIAGGIO / VESPA 250
 POLARIS 500
 PUCH 125
 REX 125
 SACHS 800
 SMC 125
 SUZUKI 100, 125, 200, 250, 300, 400, 500, 600, 650, 700, 750, 800, 1000, 1100, 1200, 1400
 SVM 350
 SYM 125
 TRAILBLAZER 170
 TRIUMPH 750, 790, 865, 885, 955, 956, 2300
 VENTO 250
 YAMAHA 125, 150, 180, 185, 200, 225, 250, 300, 350, 360, 400, 500, 550, 600, 660, 700, 750, 850, 900, 1000, 1100, 1200, 1300, 1900
 ZONGSHEN 125, 200

RA8HC

AMERICAN IRON HORSE 1819, 1918, 2033
 BIG DOG 1750, 1918
 BUELL 492, 1200
 DUCATI 750
 HARLEY DAVIDSON 883, 1100, 1200, 1450, 1584
 HONDA 250, 350, 433, 500, 1300
 KAWASAKI 450, 1500, 1600
 PIAGGIO / VESPA 250
 SUZUKI 1600
 SYM 125
 TITAN 2003
 VICTORY 1500
 ZONGSHEN 125, 150

RA59GC

DUKATI 748, 750, 916, 996
 LAVERDA 668, 750

RA59PP

PIAGGIO / VESPA 50

RAX92C

APRILIA 650
 BIMOTA 1000
 HONDA 125, 200, 250, 350, 500
 JAWA/CZ 125
 KAWASAKI 185, 220, 250, 400, 500, 550, 600, 750, 900, 1000
 KTM 650
 MAGNI 1000, 1100
 MOTO GUZZI 1000
 SUZUKI 250, 500, 550, 600, 650, 750, 1100, 1150

RAX92DC

SUZUKI 750, 1000, 1100, 1200

RAX92YC

GILERA 350, 500, 550
 HONDA 125, 500, 600, 650, 700, 750, 1000, 1300
 KAWASAKI 250, 305, 400, 550, 600
 KTM 500, 600, 620, 625, 650
 MZ 660, 850
 PUCH 500, 560
 SUZUKI 250, 350, 500, 600, 650, 750, 800, 1100, 1150
 TRIUMPH 750, 885, 1000, 1180, 1200
 YAMAHA 600, 660, 850

RC6YCC (OE094)

HONDA 450

RC7BMC (OE021)

MZ 1000

RC7BYC4 (OE077)

BMW 850, 1100, 1200
 PIAGGIO / VESPA 422

RC7PYCBX

POLARIS 500, 600, 700, 800

RC7YC (OE043)

POLARIS 330, 334, 400, 500, 800

RC7YCC (OE014)

BMW 850, 1100, 1200

RC8DMC (OE026)

BMW 850, 1100, 1150, 1200
 G+G 1130, 1200

RC8WYP4 (OE179)

KAWASAKI 2000

RC9YC (OE005)

MOTO GUZZI 650
 POLARIS 325

RC9YC4 (OE039)

HONDA 1500, 1800

RC12YC (OE013)

ARGO 480, 570, 614
 BUSH HOG
 COLUMBIA PAR CAR
 HONDA 500, 650
 POLARIS , 325, 330, 400, 425, 500
 POWER TRAC
 ZONGSHEN 125

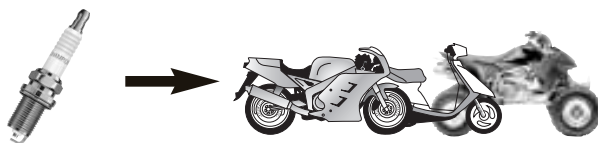

RC14YC	...RG4HC (OE092)	RG96C	RJ18YC
AMERICAN PRIDE HYDRO TRAXX MANCO STREAKER	VYRUS 999 YAMAHA 125, 250, 500, 600, 750, 1000 ZONGSHEN 50, 100	APRILIA 100, 125, 150, 650 ARCTIC CAT 375, 500, 650 CAGIVA 125 DERBI 660 HRD 125 HUSQVARNA 510, 570, 610 ITALJET 50, 125, 150 KAWASAKI 125, 400, 650, 700, 750, 800 MALAGUTI 125, 150 MBK 125, 150, 400 MZ 150 PEUGEOT 50, 125, 150, 250 PIAGGIO / VESPA 125 SUZUKI 125, 150, 400, 500, 1250 UNILLI 150 YAMAHA 125, 150, 400, 500, 600, 660, 700	SACHS 30
RCJ6Y	RG4PHP (OE122)	RGU94C	RJ19LM
GO-PED	APRILIA 250 BAJAJ 220 KAWASAKI 650, 1000, 1400 MOTO GUZZI 877, 1100, 1200 PIAGGIO / VESPA 50, 250 SUZUKI 1000 YAMAHA 1000	DAELIM 100, 125 HONDA 50, 125, 150, 250, 400, 500, 600, 750, 900, 1100, 1300 HYOSUNG 125	AMPHICAT ARGO CARTER MANCO MINATI SPD STREAKER TAURUS TERRA-JET TRAILSPOORT TRI-SPORT WHIZZER
RCJ7Y	RG6YC	RH8C	RL78C
PHANTOM	APRILIA 125, 200, 300 BMW 125, 200 GILERA 50, 500 HONDA 125, 680 KAWASAKI 900 MALAGUTI 500 PEUGEOT 50 PIAGGIO / VESPA 125, 150, 198, 200, 400, 460 ROYAL ENFIELD 350, 500 SYM 500 YAMAHA 250 ZONGSHEN 125	HARLEY DAVIDSON , 175	ACCESS 50, 100 ALFER 50 APRILIA 50, 51, 100 ATK 50, 90 BENELLI 50, 100 BETA 50 BS VILLA 50 CAGIVA 50 CPI 50, 100 DAELIM 50, 100 DERBI 50 GARELLI , 50, 106 HERKULES 50 HYOSUNG 50 ITALJET 50 KEEWAY 50 KOLPIN 50, 90 KTM 50, 125 KYMCO 50, 100 LEM 50 MALAGUTI 50, 70 MBK 50, 100 MOTOR TEK 50 MSA 50, 100 MZ 50 OTTO 50 PEUGEOT 80 PIAGGIO / VESPA 50, 220 RENAULT SPORT 50, 100 SACHS 50 SAN YANG 50 SANYANG 50 SYM 50, 100 UNISOM 50, 90 UNITED MOTORS 50, 90 VILLA BS 50 YAMAHA 50, 80, 100
RCJ8	RG6YCA	RH10C	
ARGO 617, 674 AVENGER FRONTIER-TML (Quadra) HEATH KIT HONCHO JOHN DEERE LITTLE DAVID TANAKA TRI-SPORT VIZA 33	APRILIA 50 PIAGGIO / VESPA 50 VICTORY 1500, 1634	CUSHMAN HUSTLER JAWA 40	
RCJ8Y	RG59V	RH12	
MOSQUITO 50, 90 PHANTOM SHANAHAN TERRATRAN 35, 41 TSI POWERED SPORTS	DUCATI 998	PUCH 50	
RD16	RG94C	RJ6C	
CUSHMAN	AJP 250 APRILIA 150, 450, 550 ARCTIC CAT 400, 454, 650 BENELLI 125, 150 BOMBARDIER 175, 200 CAGIVA 650 DAZON 150, 175, 250 EAR RACING 950 E-ATV 950 GAS GAS 400, 450 GILERA 125, 180 HERKULES 150 HIGHLAND 450, 750, 950 HONDA 125 HUSABERG 350 HUSQVARNA 250, 400, 450, 510, 610 HYOSUNG 125, 250, 650 ITALJET 125, 150 KAWASAKI 125, 250, 400, 650, 1000 KTM 250, 400, 520, 540, 950 KYMCO 125, 500 LAVERDA 650 MALAGUTI 200 MBK 125 MZ 125 PEUGEOT 125 PIAGGIO / VESPA 100, 125, 200 SACHS 125 SHERCO 450 SUZUKI 125, 200, 250, 400, 450, 650, 1000, 1400, 1800 SYM 125, 200, 250 TM 250, 450 VOR 400, 503, 530 YAMAHA 125, 152, 250, 400, 426, 450, 600, 1300	HODAKA 100 RABBIT 49 STEEN 100 SUZUKI 55, 100, 120	
RES9YCC4 (OE031)		RJ8C	
BOOM TRIKE 1600, 2000		ADVENTURER 100 ALL STATE AMERICAN CONTINENTAS ARCO E-Z RIDER ARCTIC CAT ASM 30, 50 BRISTER CARTER COOT E-Z RIDER HUSTLER KAWASAKI 75 LIL INDIAN MANCO MICHIRINA SANDPIPER SCAMP STREAKER SUZUKI 55 TECUMSEH ENGINES	
RF11YC		RJ12C	
ALL STATE CUSHMAN		ARGO	
RF14YC		RJ14YC	
CUSHMAN		HERKULES 30 SACHS 30	
RG4HC (OE092)		RJ17LM	
ALFER 125 APRILIA 125, 150, 200, 250 ATK 600 BAJAJ 95, 125, 135, 150, 180, 200, 220 BENELLI 400, 900, 1130 BETA 350 BIMOTA 600, 996, 1000, 1100 CAGIVA 1000 CANNONDALE 432, 440 CCM 650 DERBI 50, 125, 150 DUCATI 748, 749, 992, 998 HONDA 125, 250, 500, 750, 800, 900, 1100 HRD 125 ITALJET 125 KAWASAKI 250, 400, 500, 600, 636, 750, 800, 900, 1000, 1100, 1200 KTM 250, 450, 477 MALAGUTI 400 MBK 125 MOTO MORINI 1200 MV AGUSTA 750, 910, 1000 PIAGGIO / VESPA 50, 125, 180, 182, 250 RENAULT SPORT 125 SACHS 650 SUZUKI 125, 250, 350, 400, 600, 650, 750, 900, 1000, 1100, 1300 TRIUMPH 600, 650, 675, 955, 1050 VERTEMATI 503		CARTER TECUMSEH ENGINES TRAILSPOORT	RL82C (OE086)
			ACTION AMC 100, 125, 175, 250 APRILIA 25, 50 ARGO BENELLI 50 BETA 50, 125 BM 49 BS VILLA 50 BUFFALO 50 CAGIVA 350 CASAL 50 CECCATO 100 CHRYSLER ENGINES CIMATTI 50 COSSACK 125, 175, 350, 650 DALESMAN 125 DERBI 49, 50, 75 DOT 50, 175, 197, 246

**...RL82C**

DUCATI 350, 450, 500
 FAMEL , 50
 FANTIC 50, 240
 GARELLI 35, 50
 GEACE CICLOS
 GIULIETTA PERIPOLI 50
 GREEVES
 HODAKA 125
 HONDA 50, 100
 ITALJET 50, 80, 100, 125
 KAWASAKI 75, 90, 100
 KREIDLER 50, 80
 KTM 50
 K-ZWO 50
 LEM 50
 MACAL 50
 MAICO 125, 175, 350
 MALAGUTI 50, 100
 MALANCA 125, 150
 MBK 49, 50, 80
 MINARELLI 50, 60, 80
 MINATI
 MINI BRUTE
 MOBYLETTE (GAC) 49
 MONARK 125
 MONDIAL 48, 160
 MOTO VESPA 49, 75, 125
 MOTOBECANE (MBK/Yamaha) 49, 75
 MOTOGAC 50
 MOTORI MORINI FRANCO 50, 100
 MOTRON 50
 MUSTANG
 MZ 50
 NEVAL 125, 150, 250, 350, 650, 750
 OTTO 50
 PEUGEOT 50, 80
 PIAGGIO / VESPA 50, 80, 90, 100, 125, 150
 PREMIER BEBE
 PUCH , 49
 RIEJU 50
 RIERA 50
 SACHS , 50
 SIAM 50
 SIAMOTO 50
 SOLO 50
 SUZUKI 50, 75, 100, 120, 125, 185, 350, 500
 TECNOMOTO 50, 80
 TEMPO 100
 TERRA-JET
 TOKAIDO 50
 TOMOS 49
 TRIUMPH 200
 VILLIERS 122, 147, 148, 173, 197, 225, 246,
 250, 325, 350
 WSK 125, 175
 YAMAHA 50, 60, 65, 70, 75, 80, 90, 100, 125
 ZANELLA 100, 125

RL82YC (OE064)

AEON 50, 100
 APRILIA 50
 ARCTIC CAT 90
 ATALA 50
 BAROSSA MOTOR 50, 100
 BOMBARDIER 50, 83
 BS VILLA 50
 BSM 50, 100
 CAGIVA 49, 50, 600, 650, 750
 CHUNLAN 50
 DAELIM 50
 DAREN 50, 100
 DINLI 50, 90
 DUCATI 350, 400, 500, 600, 650, 750, 864, 972
 E-TON 50, 90
 FOX 50, 100

...RL82YC (OE064)

GARELLI 50, 110
 HARLEY DAVIDSON 1000
 HERKULES 50, 80, 100
 HONDA 50, 55, 75, 80, 90, 100, 125
 HYOSUNG 50, 90
 ITALJET 50
 KREIDLER 50
 MALAGUTI 50
 MANCO 50, 90
 MBK 49, 50
 MZ 50
 PEGASUS 50
 PEUGEOT 50
 PGO 50, 80, 82, 90, 110, 125
 POLARIS 50, 90
 REX 25, 50
 RIVERO 50
 SACHS 50, 80, 100, 110
 SASY 50
 SIAM 50
 SIAMOTO 25, 50
 SMC 50, 90, 100
 SUZUKI 50, 70, 75, 80, 100, 110, 120, 125, 250
 SYM 50
 TGB 50
 TOMOS 49
 TRAILBLAZER 50
 UNITED MOTORS 50, 90
 VENTO 100
 VILLA BS 50
 WP 50
 YAMAHA 50, 80, 90, 100, 110, 115, 125, 135

RL86C

ACTION
 ARCTIC CAT
 ASM 90, 100
 ATTEX
 BAJAJ
 BLATA 40
 COMMUTER
 DI BLASI
 HONDA 50, 90
 INDIAN
 ITALJET 125
 KYMCO 100
 MANCO , 50, 169, 404
 MAX
 MBK 50
 MICRO-SOUND
 MIDWEST 50
 MINI BRUTE
 PEUGEOT 50
 PUCH 50
 ROYAL ENFIELD 350
 RUPPSTER
 SACHS 50
 SUNBEAM
 SUNDOWNER
 SUZUKI 50
 TRACK AND SPORTS
 YAMAHA 50

RL87YC

CAGIVA 106, 125
 EASY RIDER 50, 100
 HONDA 50, 100
 ITALJET 50
 MALAGUTI 50
 MARS 50
 MIDWEST 80
 POLARIS 50, 90
 SIMSON 50
 SUZUKI 50

RL95YC

BAJAJ 150
 KASEA 50
 KAWASAKI 50, 80
 MULAN 50
 SUZUKI 50

RNIC

APRILIA 50
 BETA 50
 PIAGGIO / VESPA 50
 SUZUKI 85

RN2C (OE091)

APRILIA 50, 125, 150, 250
 ARGO
 ARM 125, 250, 350
 ASPES 50, 125
 ATK 125, 249, 250, 260, 406
 ATTEX
 BENELLI 125
 BETA 50, 125
 BIMOTA 500
 BOMBARDIER 50, 90, 176, 330, 400, 498, 644,
 653
 CAGIVA 50, 125, 200, 250
 CAN-AM 125, 175, 250, 275, 370, 400
 CASAL 50, 125
 DERBI 50, 75, 125, 200, 250
 FANTIC 50, 75, 80, 125, 250
 GARELLI 35, 50, 125
 GAS GAS 50
 GILERA 50, 80, 123, 125, 150, 176, 250
 HARLEY DAVIDSON 125, 175, 250
 HERKULES 50
 HIRO MOTORI 125
 HONDA 50, 60, 75, 80, 85, 125, 150, 200, 250,
 450
 HUSQVARNA 50, 125, 250, 390, 420, 430, 450,
 500
 ITALJET 50, 125
 KAWASAKI 60, 80, 125, 175, 250, 400, 420,
 450, 750
 KTM 125, 200, 250, 300
 LAVERDA 125, 175, 250, 750, 1000, 1200
 MAICO 400
 MBK 50
 MINARELLI 50, 125
 MONTESA 50, 75
 MOTO GUZZI 125
 MOTO VESPA 50, 125, 200
 MOTO VILLA 50, 80, 125, 350, 380
 MOTOR HISPANIA 50
 PIAGGIO / VESPA 50, 75, 80, 125, 150, 180
 PRAIRIE BOBCAT 340
 PUCH 75
 ROYAL ENFIELD 500
 SACHS 125
 SHERCO 50
 SUZUKI 50, 80, 100, 125, 200, 250, 400, 500,
 550, 750, 850
 SVM 50
 TM 125
 TRI-SPORT
 YAMAHA 50, 80, 100, 125, 200, 240, 250, 350,
 400, 490

RN3C (OE108)

ALFER 250
 AMC 250, 370
 AMERICAN EAGLE 150, 750
 APRILIA 50
 ARGO
 ATTEX
 BENELLI 50, 125, 250

...RN3C (OE108)

BETA 50, 125, 240, 250, 260
 BUFFALO 50
 CAGIVA 50, 75, 125, 175, 250, 350
 CCM 250
 CECCATO 75, 100, 125, 175
 CIMATTI 100, 150, 160
 CPI 50
 DALESMAN 125
 DERBI 75
 FANTIC 50, 75, 80, 100, 125, 211, 240, 300
 GARELLI 125
 GAS GAS 200, 250, 300
 GBM 345, 750
 GILERA 98, 125, 150, 200
 GREEVES
 HARLEY DAVIDSON 100, 250
 HERKULES 294
 HONDA 50, 75, 80, 90, 125, 135, 200, 220, 240,
 250, 350, 360, 400, 500
 HOREX 400
 HRD 50
 HUSQVARNA 250
 HUSTLER
 ITALJET 125
 KAWASAKI 50, 80, 100, 110, 125, 140, 185,
 200, 250, 300, 420, 440, 450, 500, 700, 750, 900,
 1000, 1100, 1300
 KEEWAY 50
 KTM 125, 200, 250, 360
 LAVERDA 50, 125, 200, 1000, 1200
 MACAL 50
 MAX 340, 399, 440
 MBK 50
 MIDWEST 100
 MINARELLI 125
 MONTESA 125, 250, 350
 MOTO GUZZI 125, 250, 350, 750
 MOTO MORINI 100, 175
 MOTO VESPA 125
 MOTO VILLA 125, 250, 450
 MOTOBECANE (MBK/Yamaha) 80, 125, 350
 MOTOGAC 50
 MOTORI MORINI FRANCO 100, 125
 MSA 50
 NVT 500
 PEUGEOT 50, 100, 125
 PIAGGIO / VESPA 200
 POLARIS 250, 283, 300, 350, 379, 400
 RENAULT SPORT 50
 RIEJU 50, 125
 SACHS , 50, 125
 SHERCO- HRD 50
 SUZUKI 80, 100, 120, 125, 230, 240, 250, 325,
 400, 450, 500, 850, 1000, 1100
 SVM 125
 TECNOMOTO 50
 TM 250, 300
 TRIUMPH 125, 250, 500
 VELOCETTE 350, 500
 VILLIERS 246
 YAMAHA 50, 60, 75, 80, 100, 125, 165, 175,
 180, 200, 250, 350, 360, 400, 425, 465, 500, 650

RN4C (OE098)

AMC 750
 ARGO
 BENELLI , 50, 650
 BETA 50
 BM 49
 BULTACO 175
 CCM 500
 CIMATTI 50
 CPI 50, 125, 150, 200
 FANTIC 50
 GARELLI 50

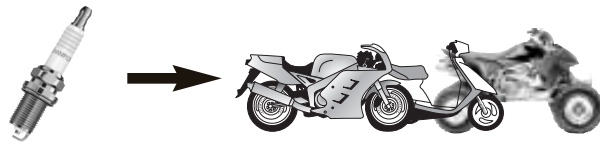

...RN4C (OE098)

GILERA 50, 90, 125
 HARLEY DAVIDSON 125
 HERKULES 50
 HONDA 175, 250
 ITALJET 350
 KAWASAKI 50, 125, 175, 200, 250, 400, 440, 650, 750
 KTM 250, 300
 LAMBRETTA 125, 150, 200
 LAVERDA 50
 MALAGUTI 50
 MANCO
 MINARELLI 50
 MINATI
 MONTESA 123, 125, 175
 MOTO BM 125
 MOTO GUZZI 50, 500
 MOTO MORINI 50, 150, 165, 175
 MOTO VESPA 150
 PIAGGIO / VESPA 50, 80, 200
 SACHS 294
 STREAKER
 SUZUKI 80, 185, 250, 400, 425
 TRAILSPORE
 VELOCETTE 350
 YAMAHA 100, 125, 175, 195, 200, 250

RN5C

AMC 100, 250
 ASPES 50
 BENELLI 50
 BETA 50, 72, 125, 250
 BRISTER
 CARTER
 DOT 175
 GARELLI 35, 50
 GILERA 50
 HONDA 50
 INTRAMOTOR GLORIA 50
 ITALJET 50, 125
 KAWASAKI 750
 MALAGUTI 50
 MERLIN 125
 MINARELLI 50
 MONTESA 315
 MOTO GUZZI 50
 MOTO VESPA 200
 MOTOBECANE (MBK/Yamaha) 49
 MOTORI MORINI FRANCO 50
 NEGRINI 50
 NVT 500
 ROYAL ENFIELD 350
 TRIUMPH 750
 VELOCETTE 350, 500
 VELOSOLEX 49
 VINCENT 500, 1000
 YAMAHA 50
 YERF-DOG 150

RN6YC (OE116)

PIAGGIO / VESPA 25
 SUZUKI 50
 YAMAHA 650, 900

RN7YC (OE018)

HARLEY DAVIDSON 1000
 MONTESA 309
 MOTO GUZZI 350
 SUZUKI 250
 YAMAHA 535, 750, 1000, 1100

RN7YCC (OE008)

KAWASAKI 80, 1300
 MONTESA 50, 200, 240, 250
 MOTO MORINI 125, 250, 350, 400, 500, 501
 SUZUKI 50, 80, 250
 YAMAHA 100, 120, 150, 250, 400, 500, 535, 650, 850

RN9LCC (OE060)

BUSH HOG
 CUB CADET

RN9YC (OE006)

COSMO
 MANCO

RN9YC4 (OE048)

BRISTER
 TITAN 1573, 1753, 1852

RN9YCC (OE004)

BULTACO 125, 200, 250, 290
 BUSH HOG
 CARTER
 GAS GAS 125, 200, 250, 320, 350
 GBM 1064
 GREEVES
 JOHN DEERE
 KAWASAKI 520, 540, 750, 1300
 MOTO GUZZI 877, 1100, 1200
 MOTOBECANE (MBK/Yamaha) 49
 MOTORI MORINI FRANCO 125
 PIAGGIO / VESPA 998
 SOLIFER 50
 SUZUKI 50
 TITAN 1573
 YAMAHA 350

RN11YC (OE051)

MANCO
 MINATI
 STREAKER

RN11YC4 (OE049)

AMERICAN IRON HORSE 1573, 1753, 1852
 BIG DOG 1310, 1440, 1570, 1750

RN11YCC (OE045)

CAGIVA 350
 CUB CADET
 GARELLI 320
 GAS GAS 50, 125, 160, 200, 249, 250, 270, 280, 327, 330, 350, 370
 HARLEY DAVIDSON 65, 90, 125
 JOHN DEERE 250, 290
 KAWASAKI 300
 MANCO 450
 MECATECNO 330
 MERLIN 350
 MONTESA 125, 200, 240, 250, 330, 335, 349, 350
 MOTO VILLA 308
 SVM 125, 330

RN12YC (OE042)

HARLEY DAVIDSON 1200, 1340
 INDIAN 1442, 1640, 1720
 IRONHEART MOTOR CO. 1340
 POLARIS 653

RN13LYC (OE156)

HARLEY DAVIDSON 1340

RN14YC

BOSS HOSS 8226
 KAWASAKI 620

RN57YCC

KTM 50, 65, 125
 SUZUKI 65

RS14YC

BOSS HOSS 6000

RS14YC6

BOSS HOSS 5700

RV15YC4

CUSHMAN

RV17YC

ARGO

RZ94C

AEON 125, 180
 DERBI 250
 HONDA 110, 125
 KARCHER 250
 KAWASAKI 250
 KREIDLER 250
 KTM 65
 MOTO GUZZI 125, 250
 SACHS 250
 SUZUKI 250, 400
 TRAILBLAZER 250

RZ96C

ADLY 125
 AEON 125, 180, 220
 BOMBARDIER 90
 BSM 125
 CARTER
 CCF 125
 CPI 125, 250
 CRAZY VEHICLE 125
 DAZON 50, 150
 ERING 125
 FOX 90
 GARELLI 125, 150
 HONDA , 50, 65, 70, 80, 90, 100, 125, 185, 200, 250
 KEEWAY 125
 KREIDLER 125
 KYMCO 50, 125
 MALAGUTI 125, 150
 MOTOR TEK 125
 MSA 90
 MZ 125
 PEGASUS 125
 PGO 125, 150
 POLARIS 200
 REX 125
 SACHS 50, 125
 SUZUKI 50, 250
 SYM 125
 TRAILBLAZER 90
 YAMAHA 50, 80, 125, 150

UL81C

AMERICAN EAGLE 350
 KAWASAKI 500

WT4

HARLEY DAVIDSON 1000, 1200

Z6

BENELLI 125, 230, 250
 HONDA 50, 125, 195
 KYMCO 125, 150
 MIDWEST
 SANYANG 125
 YAMAHA 80

Z9Y

BAOTIAN 49, 50
 CHUNLAN 125
 DAELIM 110
 DINLI 150
 DRR 90
 ERING 50
 E-TON 150
 HERKULES 50
 HONDA 50, 55, 65, 70, 75, 80, 90, 100, 125, 250
 HYOSUNG 110
 JAWA/CZ 50
 JINCHENG 50, 100
 KAWASAKI 80, 90, 110, 160
 KREIDLER 50
 KYMCO 125
 K-ZWO 50, 125
 MBK 125
 MOTO GUZZI 350, 500, 650, 750
 MZ 125
 PGO 125
 QINGQI 125, 150
 SACHS 110, 125, 150
 SAN YANG 125
 SASY 50
 SIAMOTO 125
 STAR QUAD 50
 SUNDIRO 125
 SYM 125
 TGB 125
 TNG 125, 150
 UNITED MOTORS 90
 VELOCETTE 200
 VINSON 150, 250
 XING FU 150, 250
 YAMAHA 50, 80, 100, 125
 ZONGSHEN , 50, 110

**8018**

CUSHMAN

8071

AMERICAN PRIDE
ARGO 480, 570, 614
BUSH HOG
COLUMBIA PAR CAR
HONDA 500, 650
HYDRO TRAXX
MANCO
POLARIS , 325, 330, 400, 425, 500
POWER TRAC
STREAKER
ZONGSHEN 125

8332

BETA 50, 125, 250
BMW 475, 500, 600, 750, 800, 990
HARLEY DAVIDSON 1000
JCM 240, 333
KAWASAKI 80, 1300
LAVERDA 750
MONTESA 50, 200, 240, 250, 309
MOTO GUZZI 350
MOTO MORINI 125, 250, 350, 400, 500, 501
NORTON 650, 750, 850
SANGLAS 400
SUZUKI 50, 80, 185, 250
YAMAHA 100, 120, 150, 175, 250, 400, 500,
535, 650, 700, 750, 850, 1000, 1100
ZUNDAPP 50

8339

ACCOSSATO 50
AMC 100, 250, 350, 500, 750
APRILIA 50
ARGO
ARIEL 250, 350, 500, 600, 1000
ASPES 50
BENELLI , 50, 650
BETA 50, 72, 125, 240, 250
BM 49
BRISTER
BSA 50, 175, 350, 440, 500, 600, 650
BULTACO 175, 200
CAPRI 50
CARABELA 100, 125, 175, 200, 400, 450
CARTER
CCM 350, 500
CIMATTI 50
CPI 50, 125, 150, 200
DOT 175
FANTIC 50
GARELLI 35, 50
GILERA 50, 90, 125
HARLEY DAVIDSON 125
HERKULES 50
HONDA 50, 175, 250
INTRAMOTOR GLORIA 50
ITALJET 50, 125, 350
KAWASAKI 50, 80, 125, 175, 200, 250, 400,
440, 650, 750
KTM 250, 300
LAMBRETTA 125, 150, 200
LAVERDA 50
LEM 50
LML- VESPA 200
MALAGUTI 50, 75
MANCO
MERLIN 125
MINARELLI 50
MINATI
MONDIAL 50

...8339

MONTESA 123, 125, 175, 315
MOTO BM 125
MOTO GEROSA 50
MOTO GUZZI 50, 350, 500
MOTO MORINI 50, 150, 165, 175
MOTO VESPA 150, 200
MOTOBECANE (MBK/Yamaha) 49
MOTOR HISPANIA 50
MOTORI MORINI FRANCO 50, 175
MV AGUSTA 750, 800, 900
NEGRINI 50
NORTON 500, 600
NVT 500
OSSA 160
PEUGEOT 175
PIAGGIO / VESPA 50, 80, 200
RIEJU 50, 75, 80
ROYAL ENFIELD 350, 500, 700, 750
SACHS 50, 294
STREAKER
SUZUKI 80, 185, 250, 400, 425
TESTI 50
TRAILSPORT
TRIUMPH 650, 750
VELOCETTE 350, 500
VELOSLEX 49
VINCENT 500, 1000
YAMAHA 50, 100, 125, 175, 195, 200, 250, 750
YERF-DOG 150

8405

AMERICAN IRON HORSE 1573, 1753, 1852
APRILIA 125, 240, 280, 320
BIG DOG 1310, 1440, 1570, 1750
BOOM TRIKE 1600
CAGIVA 350
CCM 240, 250, 310, 320, 350
CUB CADET
DUCATI 350
GARELLI 320
GAS GAS 50, 125, 143, 160, 200, 238, 240, 249,
250, 270, 272, 280, 327, 330, 350, 370
HARLEY DAVIDSON 65, 90, 125, 1200, 1340
HIRO MOTORI 320
INDIAN 1442, 1640, 1720
IRONHEART MOTOR CO. 1340
ITALJET 250, 350
JOHN DEERE 250, 290
KAWASAKI 300
MANCO , 450
MECATECNO 330
MERLIN 350
MINATI
MONTESA 125, 200, 240, 250, 330, 335, 349,
350
MOTO VILLA 308
POLARIS 653
STREAKER
SVM 125, 330
SWM 125, 200, 240, 250, 320, 350

8415

BMW 650, 800
BRISTER
BULTACO 125, 175, 200, 250, 290, 350
BUSH HOG
CARTER
COSMO
DNEPR 650
GAS GAS 125, 200, 240, 250, 320, 350
GBM 1064
GREEVES
JCM 125
JOHN DEERE

...8415

KAWASAKI 520, 540, 750, 1300
KTM 50
LEM 50
MANCO
MBK 49, 50
MONTESA 310, 311
MOTO GUZZI 700, 750, 850, 877, 1000, 1100,
1200
MOTO MORINI 80
MOTO SPEZIAL 1100
MOTOBECANE (MBK/Yamaha) 49
MOTORI MORINI FRANCO 125
MTV 50
OMER 50
OSSA 230, 250, 350
PIAGGIO / VESPA 998
SANGLAS 350, 400, 500
SCORPA 250, 280
SHERCO 125, 250
SOLIFER 50
SUZUKI 50, 200
TITAN 1573, 1753, 1852
URAL 650
YAMAHA 125, 350, 360, 1100
ZUNDAPP 50

8654

BIMOTA 600
CCM 500
HONDA 800
KAWASAKI 750
YAMAHA 600

8698

AJP 250
ALFER 125
APRILIA 100, 125, 150, 200, 250, 450, 550, 650
ARCTIC CAT 375, 400, 454, 500, 650
ATK 600
BAJAJ 95, 125, 135, 150, 180, 200, 220
BENELLI 125, 150, 400, 900, 1130
BETA 350
BIMOTA 50, 600, 996, 1000, 1100
BOMBARDIER 175, 200
CAGIVA 125, 650, 1000
CANNONDALE 432, 440
CCM 650
DAELIM 100, 125
DAZON 150, 175, 250
DERBI 50, 125, 150, 660
DUCATI 748, 749, 992, 998
EAR RACING 950
E-ATV 950
GAS GAS 400, 450
GILERA 125, 180
HERKULES 150
HIGHLAND 450, 750, 950
HONDA 50, 125, 150, 250, 400, 500, 600, 750,
800, 900, 1000, 1100, 1300
HRD 125
HUSABERG 350, 400, 499, 500, 501, 600
HUSQVARNA 250, 350, 400, 410, 450, 510,
570, 577, 580, 610
HYOSUNG 125, 250, 650
ITALJET 50, 125, 150
KAWASAKI 125, 250, 400, 500, 600, 636, 650,
700, 750, 800, 900, 1000, 1100, 1200, 1400
KTM 250, 400, 450, 477, 520, 540, 950
KYMCO 125, 500
LAVERDA 650
MALAGUTI 125, 150, 200, 400
MBK 125, 150, 400
MINARELLI 50, 125
MOTO GUZZI 877, 1100, 1200

...8698

MOTO MORINI 1200
MV AGUSTA 750, 910, 1000
MZ 125, 150
NORTON 588
PEUGEOT 50, 125, 150, 250
PIAGGIO / VESPA 50, 100, 125, 180, 182, 200,
250
RENAULT SPORT 125
SACHS 125, 650
SHERCO 450
SUZUKI 125, 150, 200, 250, 350, 400, 450, 500,
600, 650, 750, 900, 1000, 1100, 1250, 1300,
1400, 1800
SYM 125, 200, 250
TM 250, 450
TRIUMPH 600, 650, 675, 955, 1050
UNILLI 150
VERTEMATI 503
VOR 400, 503, 530
VYRUS 999
YAMAHA 125, 150, 152, 250, 400, 426, 450,
500, 600, 660, 700, 750, 1000, 1300
ZONGSHEN 50, 100

8809

AJP 125, 200
APRILIA 250, 300, 350, 600, 650
ATK 125, 348, 494, 500, 560, 600
BAROSSA MOTOR 150, 170, 250
BENELLI 250, 350, 500, 650, 750, 900
BETA 125, 200
BIMOTA 750, 900, 904, 906, 1000, 1150, 1200
BMW 650, 1200
BOMBARDIER 330, 400, 500, 650
BSM 125
CAGIVA 350, 500, 900, 904
CARREFOUR 125
CCM 500, 560, 600, 636
CR & S 650
DAREN 125, 150
DAZON 175
DERBI 170
DUCATI 400, 600, 748, 750, 900, 904, 992,
1000, 1100
EAR RACING 510, 625, 992
E-ATV 510, 992
FRIGERIO MOTO 350, 500
GAS GAS 500
GILERA 125, 350, 500, 550, 600
HERKULES 300
HESKETH 1000
HMZ 125
HONDA 110, 125, 150, 175, 185, 200, 250, 300,
350, 400, 450, 500, 550, 600, 650, 680, 700, 750,
900, 1000, 1050, 1100, 1200, 1300
HUSABERG 400, 450, 470, 500, 501, 550, 650
HUSQVARNA 500, 510
HYOSUNG 125
ITALJET 250, 350
JAWA/CZ 125, 500, 650
JINCHENG 125
JOHN DEERE 500, 650
KARCHER 170
KAWASAKI 50, 185, 220, 250, 300, 305, 360,
400, 450, 500, 550, 600, 650, 700, 750, 900,
1000, 1200, 1500
KEEWAY 125, 150
KREIDLER 125, 170
KTM 125, 250, 350, 400, 450, 500, 510, 520,
525, 540, 565, 600, 609, 612, 620, 625, 640, 650,
654, 1000
KYMCO 125, 150
K-ZWO 125
LAVERDA 350, 500, 600



...8809

LINHAI 260
MAGNI 1000, 1100
MALAGUTI 250
MANCO 260
MBK 125, 250, 300
MERLIN 452, 500
METEORIT / ATU 125
MIDWEST 125, 150, 200
MOTO GUZZI 250, 350, 400, 1000, 1100
MOTOR TEK 175
MZ 500, 660, 850
NORTON 650
PIAGGIO / VESPA 250
POLARIS 500
PUCH 125, 500, 560
REX 125
SACHS 800
SMC 125
SUZUKI 100, 125, 200, 250, 300, 350, 400, 500, 550, 600, 650, 700, 750, 800, 1000, 1100, 1150, 1200, 1400
SVM 350
SYM 125
TRAILBLAZER 170
TRIUMPH 750, 790, 865, 885, 955, 956, 1000, 1180, 1200, 2300
VENTO 250
YAMAHA 125, 150, 180, 185, 200, 225, 250, 300, 350, 360, 400, 500, 550, 600, 660, 700, 750, 850, 900, 1000, 1100, 1200, 1300, 1900
ZONGSHEN 125, 200

8812

AMERICAN IRON HORSE 1819, 1918, 2033
ARCTIC CAT 246, 250, 300
BETA 125, 150
BIG DOG 1750, 1918
BMW 750, 990, 1000, 1100
BUELL 492, 1200
DUCATI 750
ERING 250
FYM 125, 150
GUANRI 125, 150
HARLEY DAVIDSON 883, 1100, 1200, 1450, 1584
HONDA 125, 250, 350, 400, 433, 450, 500, 550, 700, 750, 800, 1100, 1300, 1500
KAWASAKI 160, 400, 450, 750, 1500, 1600
KYMCO 125, 150, 250, 300
PEUGEOT 250
PIAGGIO / VESPA 250
QINGQI 125, 150
SANLG 125, 150
SUZUKI 125, 160, 185, 230, 250, 280, 800, 1400, 1500, 1600
SYM 125
TIANYI 125, 150
TITAN 2003
VICTORY 1500
YAMAHA 185, 200, 225, 230, 250, 400, 550, 600, 650, 1300, 1600, 1670
ZONGSHEN 125, 150

8814

ACTION
ADLER 200, 250
AEON 50, 100
AMC 100, 125, 175, 250
AMERICAN EAGLE 350
APRILIA 25, 50
ARCTIC CAT 90
ARGO
ARIEL 350, 500, 650, 1000
ATALA 50

...8814

AWO 425
BAROSSA MOTOR 50, 100
BENELLI 50, 125
BETA 50, 125
BIMOTA 750
BLANEY 79, 90, 100
BM 49
BMW 494, 500
BOMBARDIER 50, 83
BOOM TRIKE 1600
BS VILLA 50
BSA 250, 350, 500
BSM 50, 100
BUFFALO 50
BULTACO 75
CAGIVA 49, 50, 350, 600, 650, 750
CARREFOUR 50
CASAL 50
CCF 50, 100
CECCATO 100
CHRYSLER ENGINES
CHUNLAN 50
CIMATTI 50
CLIPIC 50
COSSACK 125, 175, 350, 650
DAELIM 50
DALESMAN 125
DAREN 50, 100
DERBI 49, 50, 75
DINLI 50, 90, 100
DKW 48, 50, 175
DNEPR 650
DOT 50, 175, 197, 246

DUCATI 100, 125, 175, 250, 350, 400, 450, 500, 600, 650, 750, 864, 900, 972
DÜRRKOPP 150, 175, 194, 200
ERING 50
E-TON 50, 90
FAMEL 50
FANTIC 50, 125, 200, 210, 240
FOX 50, 100
G.A.C. Mobyte. 50
GARELLI 35, 50, 110
GEACE CICLOS 50
GIULIETTA PERIPOLI 50
GÖRICKE 50
GREEVES
HARLEY DAVIDSON 1000
HEINKEL 175
HERKULES 50, 80, 100
HODAKA 125
HONDA 50, 55, 75, 80, 90, 100, 125
HUSQVARNA 50
HYOSUNG 50, 90, 100
INDIAN 50
ITALJET 50, 80, 100, 125
ITTECO 50
IZH 347
JAWA/CZ 48, 125, 175
KAWASAKI 75, 90, 100, 250, 500
KINETIC 50, 80
KREIDLER 50, 80
KTM 50
K-ZWO 50
LEM 50
MACAL 50
MAICO 125, 150, 175, 200, 350
MALAGUTI 50, 100
MALANCA 125, 150
MANCO 50, 90
MBK 49, 50, 80, 125
MINARELLI 50, 60, 80
MINATI
MINI BRUTE

...8814

MINSK 125
MOBYLETTE (GAC) 49
MONARK 125
MONDIAL 48, 50, 125, 160
MONTESA 50
MOTO MORINI 49, 50
MOTO VESPA 49, 75, 125
MOTOBECANE (MBK/Yamaha) 49, 75
MOTOGAC 50
MOTOR HISPANIA 50
MOTORI MORINI FRANCO 49, 50, 100
MOTOTECHNIKA 50
MOTRON 50
MUSTANG
MZ 50, 70, 125, 150, 250
NEVAL 125, 150, 250, 350, 649, 650, 750
NORTON 500
NSU 125, 175, 200, 350, 500
OTTO 50
PEGASUS 50
PEUGEOT 50, 80, 150, 155, 175, 250
PGO 50, 75, 80, 82, 90, 110, 125
PIAGGIO / VESPA 50, 75, 80, 90, 100, 125, 150, 190
POLARIS 50, 90
PREMIER BEBE
PUCH , 49, 50, 80, 125
REX 25, 50
RIEJU 50
RIERA 50
RIVERO 50
RIXE 50
RIZZATO 50
ROYAL ENFIELD 197, 250, 350
SACHS , 50, 80, 100, 110
SASY 50
SIAM 50
SIAMOTO 25, 50
SIMONINI IMEA 50
SIMSON 50, 51, 53, 70, 80, 83
SIS 50
SMC 50, 90, 100
SOLO 50
SUZUKI 50, 70, 75, 80, 100, 110, 120, 125, 185, 250, 350, 500
SYM 50
TECNOMOTO 50, 80
TEMPO 100
TERRA-JET
TGB 50
TGM 50
TOKAIDO 50
TOMOS 49, 50, 80
TORPADO 50
TORROT 50
TRAILBLAZER 50, 90
TRIUMPH 200, 650
UNITED MOTORS 50, 90
URAL 750
URAL AMERICA 650
VENTO 100
VILLA BS 50
VILLIERS 122, 147, 148, 173, 197, 225, 246, 250, 325, 350
WINKING 50
WP 50
WSK 125, 175
YAMAHA 50, 60, 65, 70, 75, 80, 90, 100, 110, 115, 125, 135
YERF-DOG 90
ZANELLA 100, 125
ZUNDAPP 50

8883

ACCESS 50, 100
ADLER 100, 125, 150, 250
AGS 125
ALFER 50
ALSPORT 171, 400, 634
AMC 150, 175, 250
AMERICAN EAGLE 175, 250
APRILIA 50, 51, 100
ATK 50, 90
BATAVUS 50
BENELLI 50, 100
BETA 50, 125
BMW 250, 600
BS VILLA 50
BULTACO 75, 100
CAGIVA 50
CASAL 50
CPI 50, 100
CYRUS 50, 73
DAELIM 50, 100
DERBI 50
DKW 48, 50, 125
DUCATI 250
DÜRRKOPP 171
ENDRESS 50
FAMEL 50
FANTIC 50, 75
FLANDRIA 50
GARELLI , 50, 80, 106
GAS GAS 50
GIULIETTA PERIPOLI 50
HEINKEL
HERKULES 50, 80, 100, 125
HM RACING 50
HONDA 50, 80, 100
HUSQVARNA 50
HUSTLER
HYOSUNG 50
INDIAN 70, 75
ITALJET 50
JAWA/CZ 50, 90, 125, 175, 250, 350, 360
KAWASAKI 90, 100, 125, 175, 250, 350, 400, 500, 750
KEEWAY 50
KOLPIN 50, 90
KREIDLER 50
KTM 50, 80, 100, 125, 175, 250, 400
KYMCO 50, 100
LEM 50
MAICO 50, 125, 175, 250, 277, 350, 360, 400
MALAGUTI 50, 70
MALANCA 125
MARS 50
MBK 50, 75, 100, 125
MINARELLI 50
MONARK 125
MONDIAL 50
MONTESA 250
MOTOBECANE (MBK/Yamaha) 125
MOTOR TEK 50
MOTORI MORINI FRANCO 50, 125
MSA 50, 100
MZ 50, 125, 150, 175, 250, 301
NSU 125, 200, 250, 500
OTTO 50
PENTON 100, 125
PEUGEOT 50, 80
PIAGGIO / VESPA 50, 80, 125, 220
PUCH 50, 80
RENAULT SPORT 50, 100
RIXE 50
SACHS 50, 80, 100, 125
SAN YANG 50
SANYANG 50

**POWER
SPORT**



...8883

SIMONINI IMEA 50
SIMSON 50, 80
SIS 50
STARFLITE 50
SUZUKI 50, 60, 75, 90, 100, 120, 125, 200, 250, 300, 500
SYM 50, 100
TEMPO 50, 100
TESTI 50, 80
TOKOYA 50, 80, 125
TOMOS 49, 50, 90
TWIST-N-GO 49
UNISOM 50, 90
UNITED MOTORS 50, 90
VELOCIFERO 50
VILLA BS 50
YAMAHA 50, 80, 90, 100, 125, 180, 200, 250, 350, 500
ZUNDAPP 50, 75, 100, 125

8902

BMW 900
FANTIC 212, 249, 250, 300
KAWASAKI 80
LML- VESPA 125, 150
MOTO GUZZI 350, 400, 500, 650, 1000
MÜNCH 1000, 1200
NORTON 745, 750
OSSA 125
PIAGGIO / VESPA 25, 50
ROYAL ENFIELD 350, 500
SUZUKI 50, 80, 125
YAMAHA 125, 135, 650, 900, 920

8904

ACCOSSATO 80
ALFER 80, 125, 250, 300, 490
AMC 250, 370, 500, 750
AMERICAN EAGLE 150, 750
APRILIA 50, 125, 150, 250
ARGO
ARM 125, 250, 350
ASPES 50, 125
ATK 125, 249, 250, 260, 406
ATTEX
AVIAN 125, 250
BAJAJ 100
BELGARDA 125
BENELLI 50, 125, 250
BETA 50, 125, 240, 250, 260
BIMOTA 500
BLATA 40
BMW 600
BOMBARDIER 50, 90, 176, 330, 400, 498, 644, 653
BSA 125, 175, 250, 500, 650, 750
BUFFALO 50
BULTACO 50, 125, 175, 200, 250, 350, 360, 370, 450
CAGIVA 50, 75, 125, 175, 200, 250, 350, 500
CAN-AM 125, 175, 250, 275, 370, 400
CAPRI 50
CARABELA 100, 125, 175, 200, 250, 360, 400, 450
CASAL 50, 125
CCM 125, 250, 350, 450, 490
CECCATO 75, 100, 125, 175
CIMATTI 100, 150, 160
CLIPIC 80
CPI 50
DALESMAN 125
DERBI 50, 75, 80, 100, 125, 200, 250
FAMEL 50

...8904

FANTIC 50, 74, 75, 80, 100, 125, 160, 175, 211, 240, 250, 260, 300, 330
G.A.C. Mobyte. 50
GARELLI 35, 50, 125
GAS GAS 50, 125, 200, 250, 300, 330
GBM 345, 750
GILERA 50, 80, 98, 123, 125, 150, 176, 200, 250
GRECAV 50
GREEVES
HARLEY DAVIDSON 50, 100, 125, 175, 250
HERKULES 50, 125, 294
HIRO MOTORI 125
HM RACING 50
HONDA 50, 60, 75, 80, 85, 90, 125, 135, 150, 200, 220, 240, 250, 350, 360, 400, 450, 480, 500
HOREX 400
HRD 50
HUSQVARNA 50, 125, 250, 260, 360, 390, 400, 420, 430, 450, 500
HUSTLER
INDIAN 50, 80, 125, 175, 200
ITALJET 50, 125, 180
JAWA/CZ 500
KAWASAKI 50, 60, 80, 90, 100, 110, 125, 140, 175, 185, 200, 250, 300, 400, 420, 440, 450, 500, 700, 750, 900, 1000, 1100, 1300
KEEWAY 50
KRAMER 250
KTM 50, 80, 85, 125, 200, 250, 300, 350, 360, 390, 420, 440, 495, 500, 540
LAVERDA 50, 125, 175, 200, 250, 750, 1000, 1200
LEM 50
MACAL 50
MAICO 125, 250, 400, 440, 450, 490, 500, 610
MALAGUTI 50, 80, 125
MAX 340, 399, 440
MBK 49, 50, 125, 250, 350
MECATECNO 50
MIDWEST 100
MINARELLI 50, 125
MONTESA 50, 75, 125, 250, 350
MOTO GEROSA 50
MOTO GUZZI 125, 250, 350, 650, 750
MOTO KOSMOS 100, 125, 250, 350, 500
MOTO MORINI 100, 175
MOTO VESPA 50, 125, 200
MOTO VILLA 50, 80, 125, 250, 350, 380, 450
MOTOBECANE (MBK/Yamaha) 80, 125, 350
MOTOGAC 50
MOTOR HISPANIA 50
MOTORI MORINI FRANCO 100, 125
MSA 50
MV AGUSTA 350, 600, 750
NVT 500
OSSA 125, 150, 175, 230, 250, 350, 500
PEUGEOT 50, 100, 125
PIAGGIO / VESPA 50, 75, 80, 125, 150, 180, 200
POLARIS 250, 283, 300, 350, 379, 400
PRAIRIE BOBCAT 340
PUCH 75, 80, 125, 175, 250, 350, 366, 500
RENAULT SPORT 50
RIEJU 50, 75, 80, 125
RIZZATO 80
ROYAL ENFIELD 100, 500
SACHS , 50, 125, 175, 250, 350
SHERCO 50
SHERCO-HRD 50
SIMONINI IMEA 50, 125, 250
SUNDIRO 50, 80
SUZUKI 50, 80, 85, 100, 120, 125, 175, 185, 200, 230, 240, 250, 325, 370, 380, 400, 425, 450, 465, 495, 500, 550, 750, 850, 1000, 1100

...8904

SVM 50, 125
TECNOMOTO 50
TESTI 125
TM 80, 125, 250, 300
TRI-SPORT
TRIUMPH 125, 250, 500, 650, 750
VALENTI 80
VELOCETTE 350, 500
VILLIERS 246
YAMAHA 50, 60, 75, 80, 100, 125, 165, 175, 180, 200, 240, 250, 350, 360, 400, 425, 465, 490, 500, 650, 750
ZUNDAPP 50, 80, 175, 350

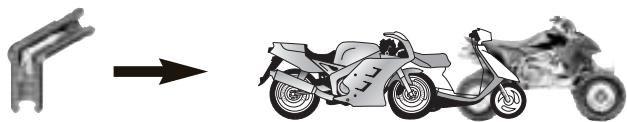

PRO-0U

KTM 250, 350, 360, 380

PRO-5M

APRILIA 25, 50, 51, 125

BMW 475, 500, 600, 650, 750, 800, 850, 900, 990, 1100

CAGIVA 125, 175, 200, 250, 350

ENDRESS 50

GAS GAS 125, 200, 250, 300

GILERA 50, 75, 80, 90, 98, 125, 500

HERKULES 50, 80, 100, 125, 175, 250, 294, 350

HONDA 50, 75, 80, 90, 125, 250, 450

HUSQVARNA 250

KAWASAKI 50, 60, 65, 80, 85, 90, 100, 125, 175, 200, 250, 300, 400, 440, 650, 750, 1000

KTM 50, 80, 100, 125, 175, 250, 400, 500, 612

KYMCO 50, 100

MBK 49, 50, 75, 80, 125, 250, 350

MONTESA 50, 75, 123, 125, 175, 200, 240, 250, 309, 310, 311, 315, 330, 335, 349, 350

MOTO GUZZI 250, 350, 650, 850, 1000

MOTOR HISPANIA 50

MZ 125, 150, 175, 250, 301

PEUGEOT 50, 80, 100

PGO 50, 80, 82, 125

PIAGGIO / VESPA 25, 50, 75, 80, 90, 100, 125, 150, 175, 180, 182, 190, 200, 220, 250, 460

PUCH 50, 75, 125

RIEJU 50

SACHS 50, 125

SUZUKI 50, 80, 90, 100, 125, 185, 200, 550

YAMAHA 50, 60, 65, 80, 90, 100, 110, 115, 120, 125, 150, 165, 175, 180, 195, 200, 240, 250, 350, 360, 400, 490, 500, 750

PRO-5U

HYOSUNG 50, 100, 110

KAWASAKI 100, 125, 250, 400, 500

PEUGEOT 50, 100

YAMAHA 250, 425, 465

SRO-5U

APRILIA 125

CAGIVA 350

HONDA 125, 250, 350, 400, 500, 550, 600, 650, 750, 800, 900, 1000, 1100

HUSQVARNA 410, 430, 500, 510, 570, 610

KAWASAKI 650, 750, 1000, 1100

KTM 400, 500, 540, 600, 609, 620, 625, 640, 650

SUZUKI 250, 400, 550, 750, 1100, 1150

YAMAHA 250, 400, 600, 750, 1100, 1200

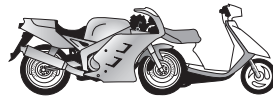

C301

BMW 750, 850, 990, 1100, 1150, 1200
MZ 1000

C302

CAGIVA 350, 600
GILERA 350, 500, 570, 600
LAVERDA 650, 750

C303

SUZUKI 750

C305

MOTO GUZZI 100, 850, 1000, 1100, 1200

C306

BUELL 1000, 1200
HARLEY DAVIDSON 883, 1000, 1100, 1200

C307

HARLEY DAVIDSON

C312

BMW 750, 850, 990, 1100

C313

BMW 1100, 1200

C314

HARLEY DAVIDSON 883, 1000, 1100, 1200

C316

APRILIA 500, 750, 850
GILERA 500
MALAGUTI 500
PIAGGIO 400
PIAGGIO 500

C320

APRILIA 125, 150, 200, 250
BENELLI 125, 150, 250
DERBI 125, 150, 200
GILERA 125, 180, 200, 250
MALAGUTI 180, 200, 250
PIAGGIO 125, 150, 180, 200, 250

C325

BMW 800, 1200

F301

BIMOTA 600, 1000
HONDA 400, 500, 600, 650, 750, 800, 900,
1000, 1100, 1500
TRIUMPH 900, 955

F302

HONDA 500, 750, 1000, 1100
KAWASAKI 450, 500, 750

F303

KTM 400, 620

F304

KAWASAKI 500

F305

MV AGUSTA 750, 910, 1000

F306

HONDA 500, 650, 750, 1000, 1100
KAWASAKI 400, 500, 600, 750, 800, 900, 1500
YAMAHA 400, 600, 750, 900, 1000, 1200, 1300,
1600, 1700, 1900

F307

KYMCO 500
YAMAHA 500, 600, 1300

F308

HONDA 300, 400, 600, 700, 750, 800, 900,
1000, 1100, 1300, 1800
KAWASAKI 400, 600, 650, 750, 900, 1000,
1200, 1400, 1500, 1600, 2000
TRIUMPH 600, 650, 675, 800, 900, 955, 1050,
2300

F310

BENELLI 900, 1130

H301

BIMOTA 900
CAGIVA 350, 650, 750, 900
DUCATI 350, 400, 500, 550, 583, 600, 620, 650,
748, 750, 800, 850, 851, 888, 900, 916, 944, 992,
996, 998, 1000, 1100
HARLEY DAVIDSON 883, 1000, 1100, 1200

H302

BENELLI 230, 250
MOTO GUZZI 850, 1000

K301

BIMOTA 750, 1100
CAGIVA 650, 1000
HUSQVARNA 570
KAWASAKI 1000
SACHS 800
SUZUKI 500, 600, 650, 700, 750, 800, 900,
1000, 1100, 1200, 1300, 1400, 1500, 1600, 1800

X301

HONDA 250, 350, 400, 500, 600, 650
KAWASAKI 125, 250, 300, 450

X302

APRILIA 660
MZ 660, 850
SACHS 125
YAMAHA 125, 180, 240, 250, 350, 400, 500,
535, 550, 600, 650, 660, 750, 850, 900, 1000,
1100

X303

HONDA 1000
KAWASAKI 250, 400, 440, 500, 550, 600, 650,
750, 900, 1000, 1100, 1200
TRIUMPH 750, 900, 1000, 1200
YAMAHA 750, 1000, 1100, 1200, 1300

X304

HONDA 250, 350, 400, 450, 500, 550, 650

X305

APRILIA 350, 600, 650
BIMOTA 650
BMW 650
MZ 125, 500

X306

YAMAHA 400, 500, 550, 600, 650, 700, 750,
900, 920

X307

SUZUKI 250, 400, 450, 500, 550, 650, 750, 850,
1100

X308

SACHS 650
SUZUKI 500, 600, 650, 750, 800

X309

SUZUKI 750

X310

KAWASAKI 200, 250, 600, 650

X311

YAMAHA 750, 850, 1100, 1200, 1300

X312

APRILIA 650, 1000
LAVERDA 1000
VOXAN 1000

X313

MBK 125
YAMAHA 125, 150, 200, 225, 350, 600

X314

KAWASAKI 750, 900, 1000, 1300

X315

BENELLI 350, 500, 650, 750, 900
HONDA 350, 360, 550, 650, 750, 900, 1000,
1100, 1200

X316

BMW 990

X317

BMW 450, 500, 600, 650, 750, 800, 900, 990

X318

MOTO GUZZI 350, 500, 650

X319

BETA 350
SUZUKI 125, 250, 350, 400

X320

BETA 250, 400, 450, 500
NHUSABERG 550, 600, 650
KTM 250, 350, 400, 450, 500, 520, 525, 540,
560, 600, 609, 620, 625, 640, 660

X321

HONDA 1000
KAWASAKI 250, 400, 440, 500, 550, 600, 650,
750, 900, 1000, 1100, 1200
YAMAHA 750, 1000, 1100, 1200, 1300

X322

HONDA 250, 350, 400, 450, 500, 550, 650

X323

SUZUKI 250, 400, 450, 500, 550, 650, 750, 850,
1100

X324

KAWASAKI 250, 305

X325

APRILIA 125, 150, 200, 250
BMW 125, 200
PEUGEOT 125, 150, 250

X327

HYOSUNG 125, 250
SUZUKI 125, 150, 200, 400

X328

KAWASAKI 125
SUZUKI 125, 250, 400

X329

MOTO GUZZI 350, 500, 650, 750

X330

ITALJET 125, 150
PIAGGIO 125

X331

DUCATI 750, 860, 864

X332

BMW 450, 500, 600, 650, 750, 800, 900, 990

X333

BMW 990

X335

BETA 250, 400, 450, 500
KTM 250, 400, 450, 477, 520, 525, 540, 560,
625, 640, 660

X337

HUSQVARNA 410, 450, 510, 610, 630

X340

KTM 950, 1000

X345

SUZUKI 400

X348

YAMAHA 250, 350, 400, 426

X349

HONDA 450

X351

KAWASAKI 250
SUZUKI 250, 450

X354

YAMAHA 250, 450

X355

YAMAHA 400

X356

HONDA 125

X357

HONDA 250, 450

**C322**

BOMBARDIER 500

F306

AIXAM 400, 500
 POLARIS 300, 325, 330, 335, 400, 425, 450,
 500, 600, 700, 800
 YAMAHA 350, 400, 450, 660, 700

F307

YAMAHA 660

F308

ARCTIC CAT 650
 KAWASAKI 300, 360, 400, 450, 540, 650, 700,
 750
 SUZUKI 700

K301

ARCTIC CAT 400, 500
 SUZUKI 400, 450, 500, 700

X301

POLARIS 500

X302

YAMAHA 600, 700

X304

HONDA 400, 500, 650, 680

X310

KAWASAKI 250, 300

X312

BOMBARDIER 330, 400, 650, 800

X313

YAMAHA 200, 225, 230, 250

X327

SUZUKI 90, 125, 185

X328

ARCTIC CAT 250, 300
 SUZUKI 160, 230, 250, 300

X345

ARCTIC CAT 400
 KAWASAKI 400
 SUZUKI 400, 450

X347

BOMBARDIER 500, 650

X348

YAMAHA 350, 400

X354

YAMAHA 450

X356

HONDA 200, 250, 300, 350, 400, 420, 450, 500

X357

HONDA 450

L300

DUCATI 600, 750, 900

L301

DUCATI 400, 600, 750, 900

F308



F310



H301



H302



K301



X301



X302



X303



X304



X305



X306



X307



X308



X309



X310



X311



X312



X313



X314



X315





X345



X347



X348



X349



X351



X354



X355



X356



X357



	D	H	By-Pass
X301	50.0	37.0	✓
X302	55.0	59.5	✓
X303	77.0	57.0	
X304	69.0	45.0	
X305	56.5	50.5	✓
X306	77.0	38.6	
X307	72.0	65.0	✓
X308	60.0	37.0	✓
X309	72.0	65.0	✓
X310	55.0	56.0	
X311	101.0	39.0	
X312	56.5	74.0	✓
X313	37.8	48.5	✓
X314	80.0	82.0	
X315	77.0	57.0	
X316	41.5	139.0	
X317	41.5	130.0	
X318	45.0	107.5	✓
X319	60.0	32.5	✓
X320	41.5	69.0	
X321	77.0	57.0	
X322	69.0	45.0	
X323	72.0	65.0	✓
X324	55.0	53.5	
X325	41.5	41.0	
X327	44.0	40.0	✓
X328	44.0	55.5	✓
X329	45.0	122.2	✓
X330	33.5	35.5	
X331	51.0	58.0	
X332	41.5	130.0	
X333	41.5	139.0	
X335	41.5	51.5	
X337	45.0	48.0	✓
X340	41.0	150.0	
X345	44.0	43.0	✓
X347	56.0	107.0	
X348	37.8	46.2	✓
X349	38.0	35.5	✓
X351	38.0	43.0	✓
X354	38.0	46.0	✓
X355	44.0	55.0	✓
X356	52.0	37.0	✓
X357	40.0	36.0	✓

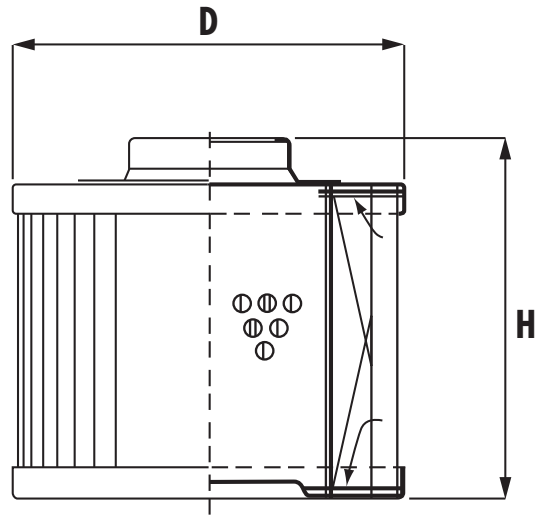

	A	B	C	D	By-Pass	Anti-Drain	Anti-Siphon
C301	71.5	76.0	81.5	3/4" -16 UNF	✓	✓	
C302	71.5	76.0	59.5	3/4" -16 UNF	✓	✓	
C303	61.5	76.0	81.5	3/4" -16 UNF	✓	✓	
C305	71.5	76.0	88.5	3/4" -16 UNF	✓	✓	
C306	71.5	76.0	88.5	3/4" -16 UNF	✓	✓	
C307	71.5	76.0	141.0	3/4" -16 UNF	✓	✓	
C312	71.5	76.0	81.5	3/4" -16 UNF	✓	✓	
C313	71.5	76.0	81.5	3/4" -16 UNF	✓	✓	
C314	71.5	76.0	88.5	3/4" -16 UNF	✓	✓	
C316	71.5	76.0	60.0	3/4" -16 UNF	✓	✓	
C320	40.0	53.0	67.0	M 14 X 1,5	✓	✓	
C322	71.5	76.0	76.0	3/4" -16 UNF		✓	
C325	71.5	76.0	59.0	3/4" -16 UNF	✓		
F301	60.0	66.0	76.0	M 20 X 1,5	✓	✓	
F302	61.5	76.0	75.0	M 20 X 1,5	✓	✓	
F303	60.0	66.0	76.0	M 20 X 1,5	✓		✓
F304	60.0	66.0	76.0	M 20 X 1,5	✓	✓	
F305	60.0	66.0	67.5	M 20 X 1,5	✓	✓	
F306	60.0	66.0	76.0	M 20 X 1,5	✓	✓	
F307	60.0	66.0	51.0	M 20 X 1,5	✓	✓	
F308	60.0	66.0	67.0	M 20 X 1,5	✓	✓	
F310	60.0	66.0	67.5	M 20 X 1,5	✓	✓	
H301	71.5	76.0	76.5	M 16 X 1,5	✓	✓	
H302	71.5	76.0	60.0	M 16 X 1,5	✓	✓	
K301	60.0	66.0	67.0	M 20 X 1	✓	✓	

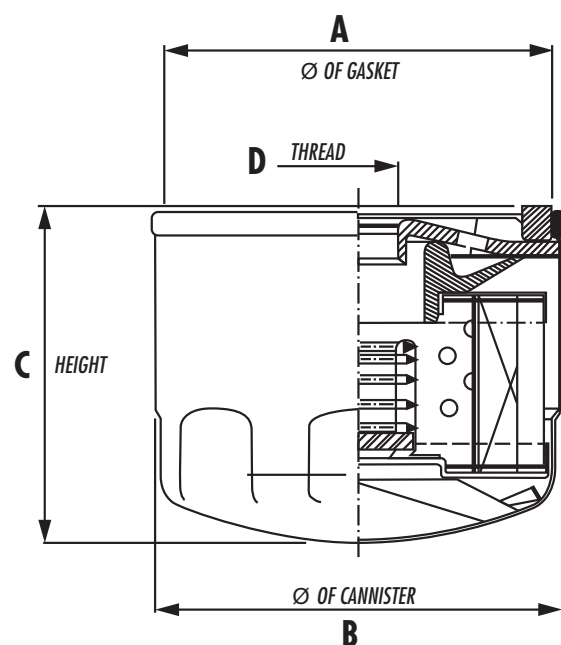
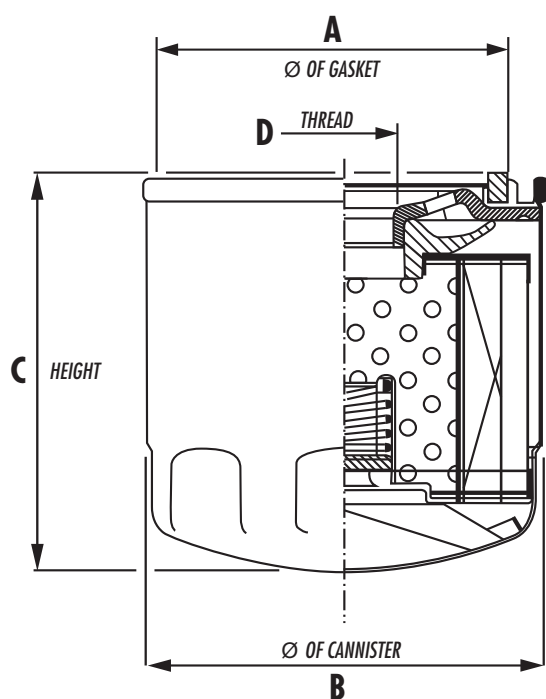



J300 YAMAHA 650, 750	J323 KAWASAKI 750, 900, 1000	U301 DUCATI 350, 400, 583, 600, 620, 650, 750, 800, 850, 851, 888, 900, 916, 944, 996, 1000	Y300 KTM 400, 609, 620
J301 HONDA 500, 650	J324 HONDA 600, 650	U302 CAGIVA 750, 900	Y301 KTM 125, 200, 250, 300, 380
J302 YAMAHA 660	J325 SUZUKI 600, 900	U303 CAGIVA 900, 1000	Y302 SUZUKI 400
J303 SUZUKI 500	J326 HONDA 500, 600	U304 YAMAHA 600	Y303 YAMAHA 350
J304 SUZUKI 600, 750, 1100, 1200	J327 YAMAHA 750	U305 LAVERDA 750	Y304 SUZUKI 650
J305 KAWASAKI 400, 500, 550	J328 HONDA 600	U306 LAVERDA 650	Y305 YAMAHA 500, 550
J306 HONDA 750, 900, 1100	J329 YAMAHA 600	U307 MOTO GUZZI 100, 1000, 1100	Y306 YAMAHA 500
J307 HONDA 600, 650	J331 YAMAHA 900	U308 SUZUKI 650	Y307 KAWASAKI 750, 1500
J308 HONDA 600	J332 SUZUKI 1000	U309 BMW 650	Y308 KAWASAKI 250, 500, 600, 750
J309 YAMAHA 750, 1000, 1100	J333 SUZUKI 600, 1200	V300 APRILIA 650, 660	Y309 PIAGGIO 125
J310 YAMAHA 600	J334 SUZUKI 600, 750, 1000	V301 VOXAN 1000	Y310 KAWASAKI 600
J311 YAMAHA 1100, 1200	J335 KAWASAKI 500	V302 BMW 850, 1100, 1150	Y311 KAWASAKI 750
J312 YAMAHA 750, 900	J336 KAWASAKI 900	V303 YAMAHA 600	Y312 KAWASAKI 1100, 1200
J313 SUZUKI 600, 700, 750, 800	J337 KAWASAKI 600	V304 SUZUKI 800	Y313 KAWASAKI 440
J314 HONDA 750	J338 HONDA 1500	V305 YAMAHA 535	Y314 KAWASAKI 650
J315 HONDA 900	J339 HONDA 1100	V306 YAMAHA 1000	Y315 KTM 400, 620
J316 HONDA 1000	J340 HONDA 1100	V307 SUZUKI 750	Y316 BMW 650
J317 HONDA 750	J341 HONDA 650	V308 YAMAHA 650	Y317 HONDA 250, 400, 450
J318 YAMAHA 750	J342 HONDA 1000	V309 YAMAHA 600	Y318 APRILIA 125, 150
J319 YAMAHA 750, 1000	J343 HONDA 600	V310 SUZUKI 600, 700, 750, 800	Y319 KAWASAKI 600
J320 KAWASAKI 550, 600, 750	J345 HONDA 650	V311 YAMAHA 600, 750, 850, 900, 1000, 1100	Y320 SUZUKI 1400
J321 SUZUKI 750, 1100	J346 HONDA 800	V312 HONDA 650	Y321 YAMAHA 500
J322 SUZUKI 600, 1100	U300 MOTO GUZZI 650, 750, 850, 1000	V313 HONDA 500	Y323 HUSQVARNA 610



Y324
YAMAHA 500
Y325
YAMAHA 1000
Y327
YAMAHA 600
Y328
YAMAHA 1300
Y329
YAMAHA 1300
Y330
YAMAHA 1200
Y331
YAMAHA 600
Y334
SUZUKI 650
Y335
SUZUKI 600, 750
Y336
SUZUKI 600, 750
Y337
KAWASAKI 1100, 1200
Y338
KAWASAKI 1500, 1600
Y339
HONDA 1200
Y340
HONDA 1100
Y341
HONDA 600
Y342
KAWASAKI 500

J329



J331



J332



J333



J334



J335



J336



J337



J338



J339



J340



J341



J342



J343



J345



J346



U309



Y324



Y325



Y327



Y328



Y329



Y330



Y331



Y334



Y335



Y336



Y337



Y338



Y339



Y340



Y341



Y342



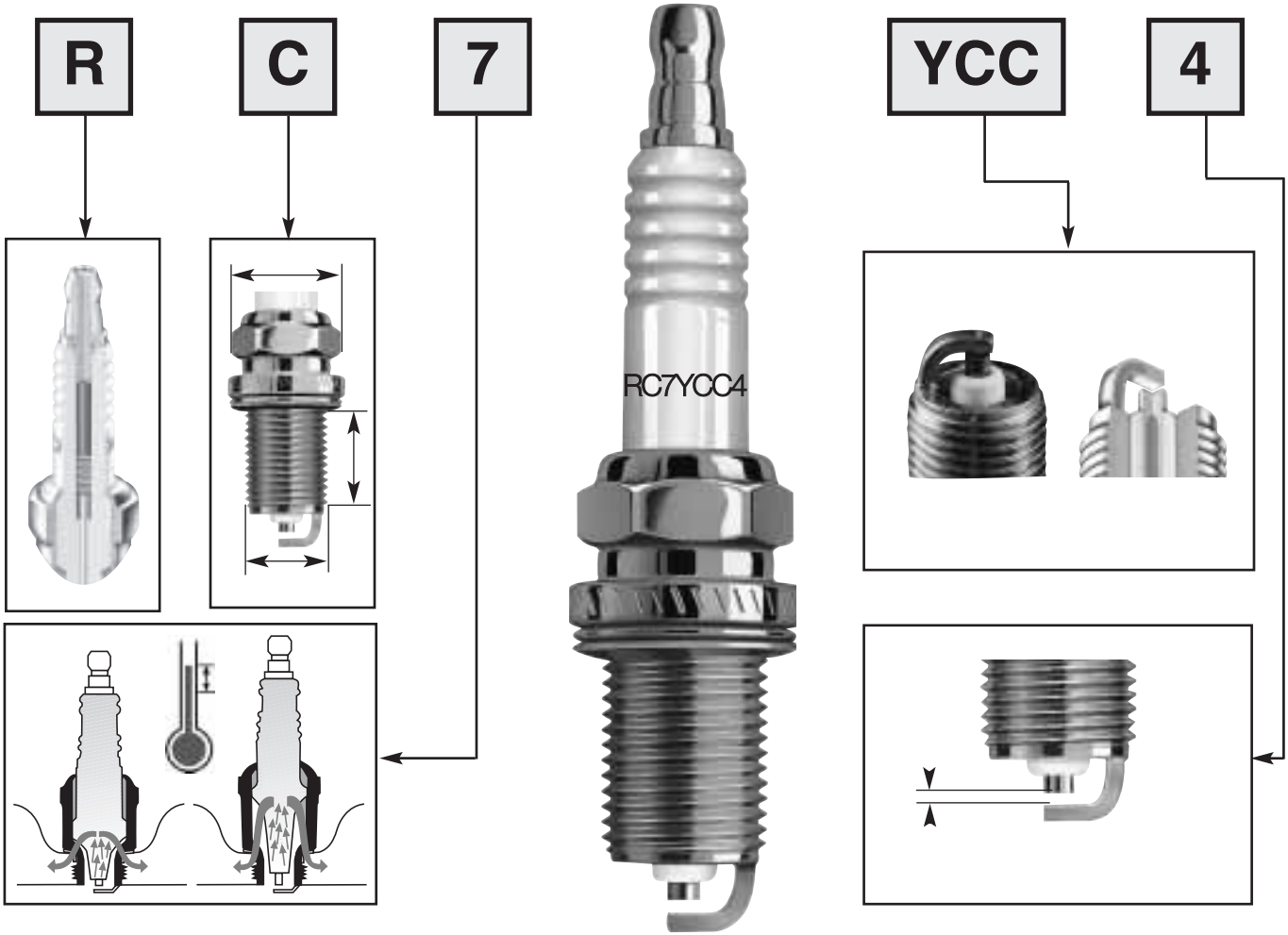

R
C
7
YCC
4

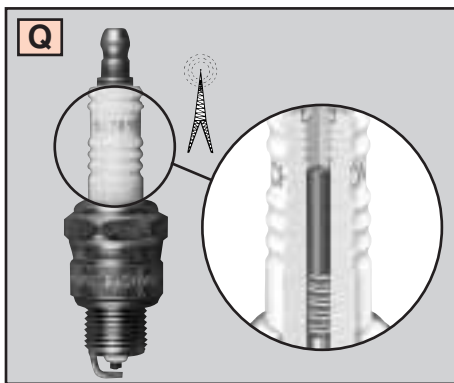

Q
 Resistor
 Resistance
 Widerstand/
 Resistor
 Resistore
 Resistencia
 Weerstand
 Resistência
 ΑΝΤΙΣΤΑΣΗ

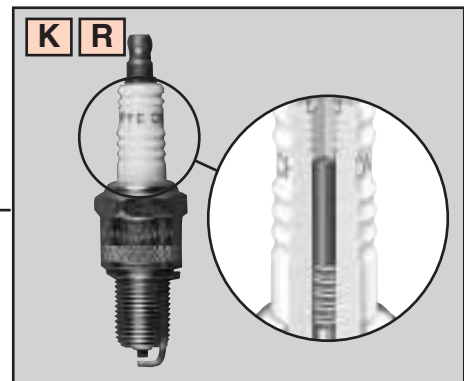

K R

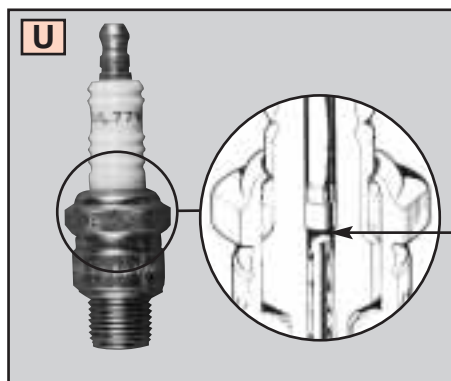

U
 Auxiliary gap
 Ecartement auxillaire
 Elektrodenabstand
 Scarica auxiliare
 Seperación auxiliar
 Extra onderbreking
 Folga auxiliar
 ΔΙΑΚΕΝΟ

R C 7 YCC 4

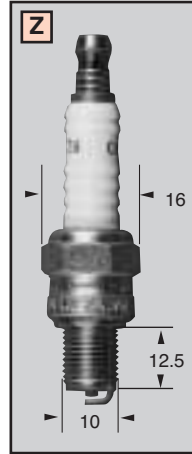
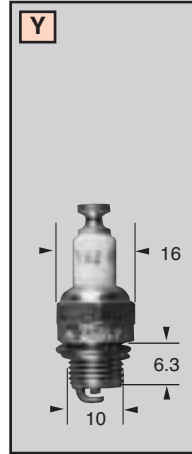
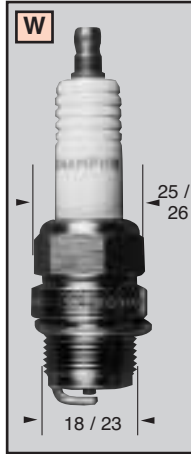
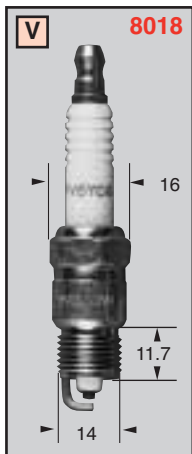
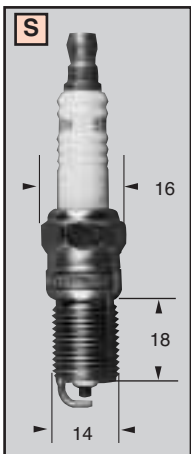
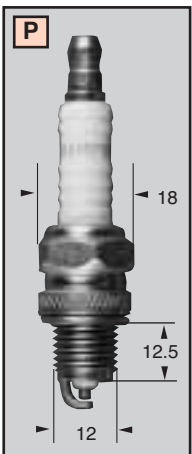
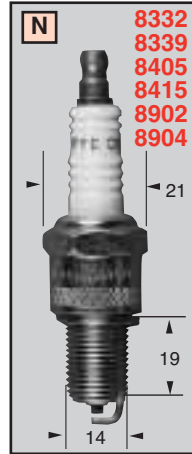
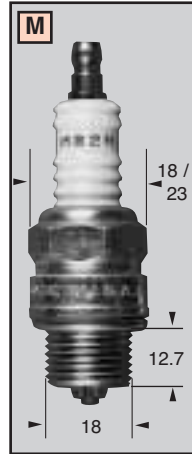
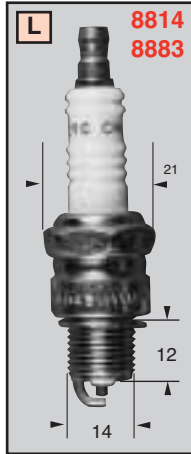
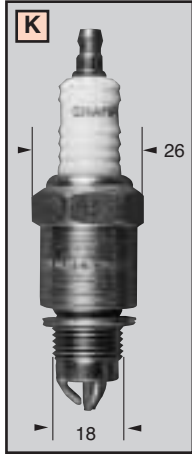
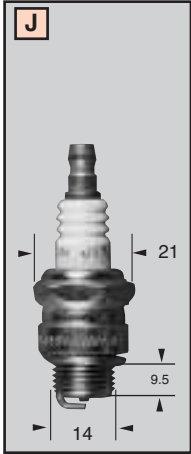
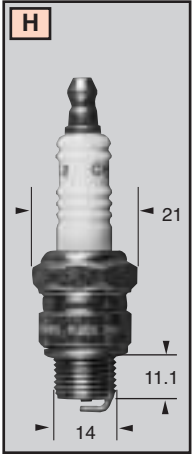
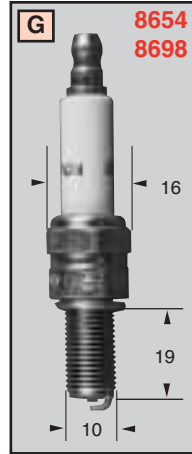
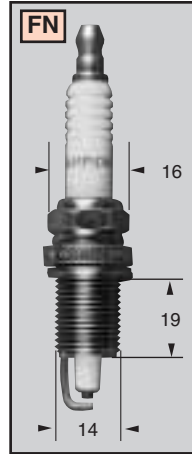
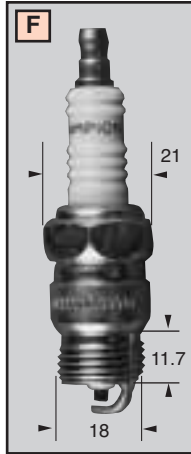
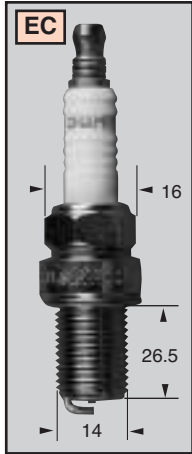
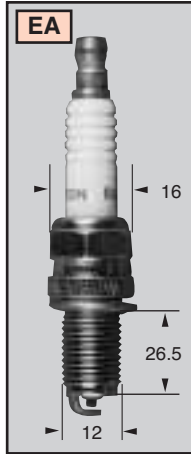
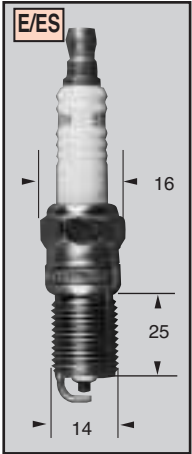
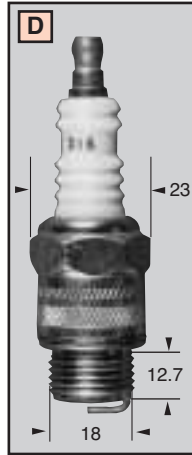
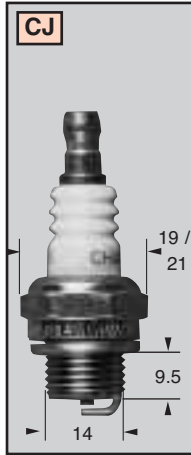
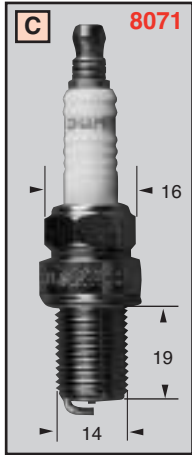
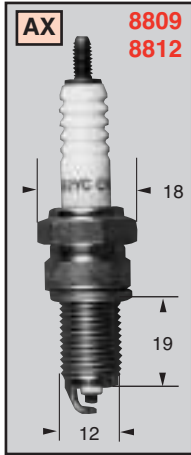
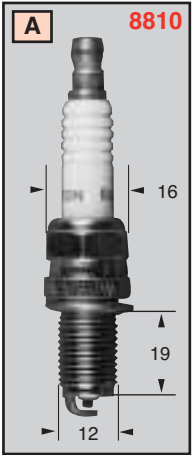

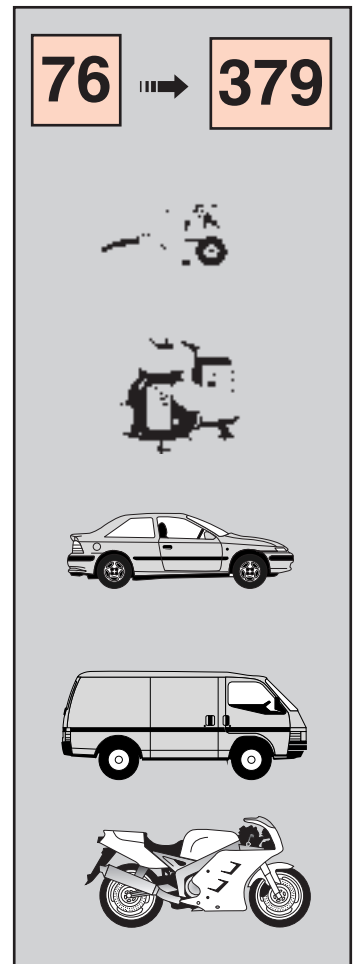
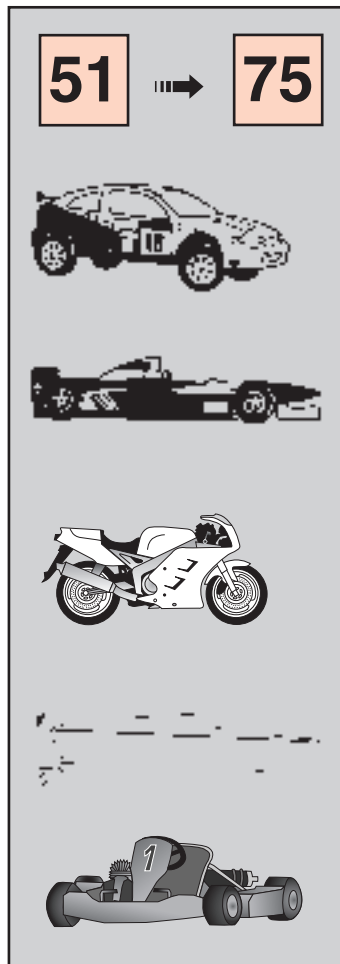
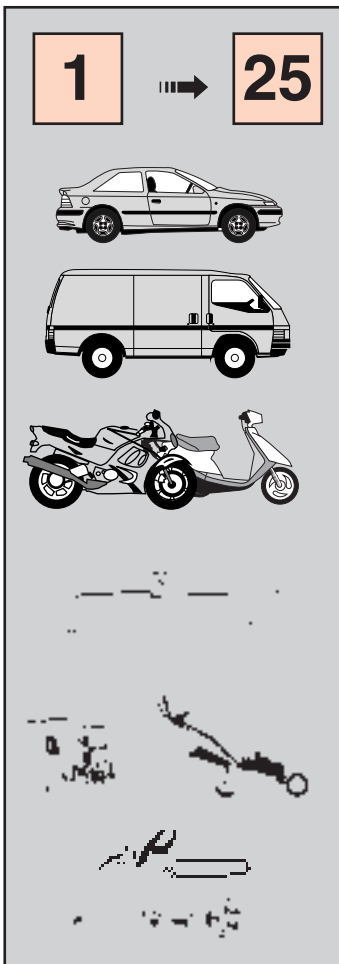
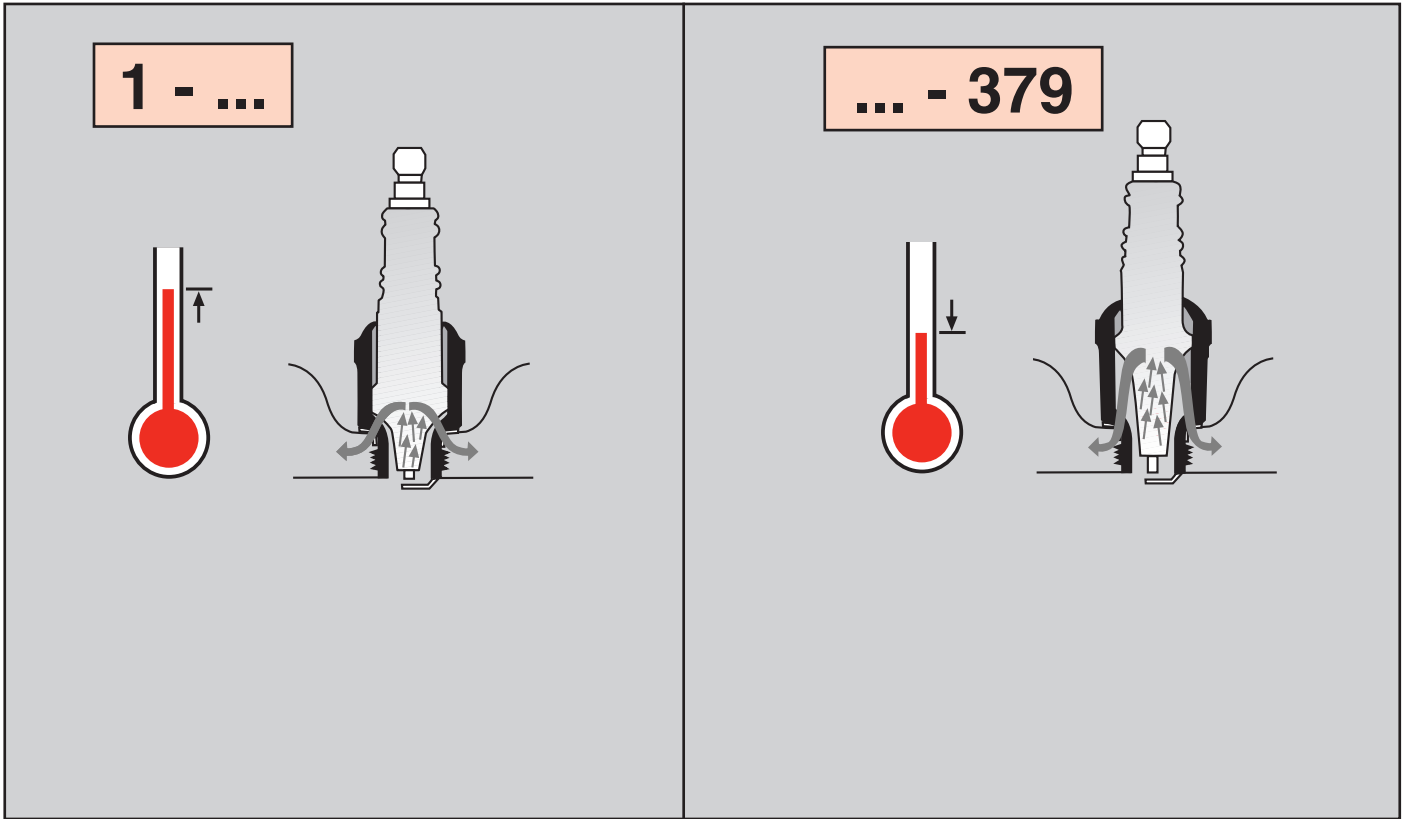

R C 7 **YCC** 4

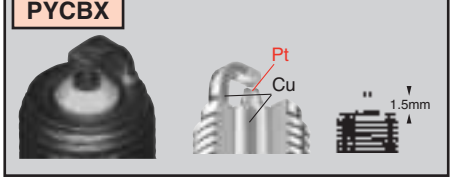
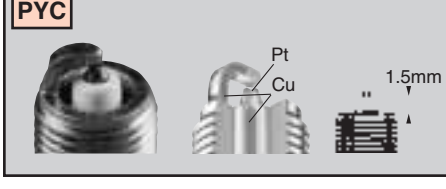
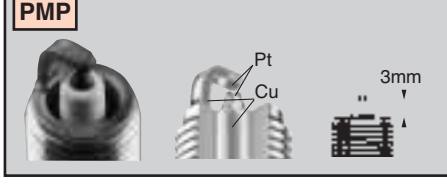
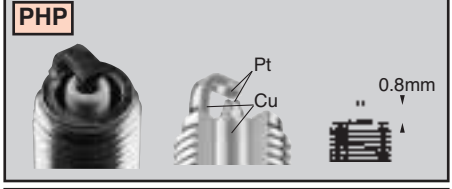
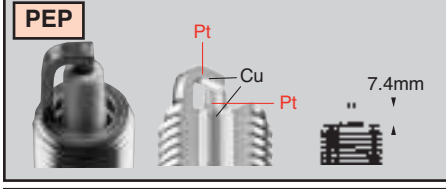
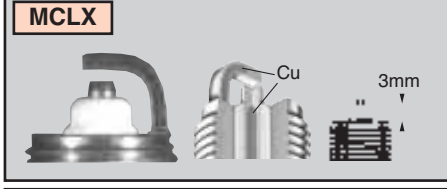
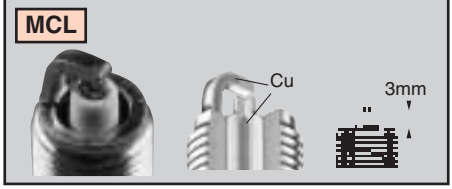
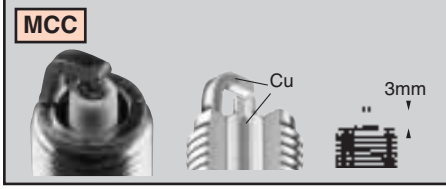
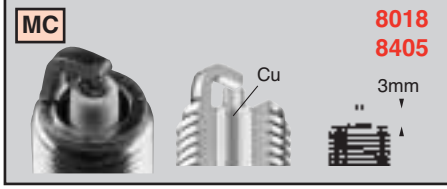
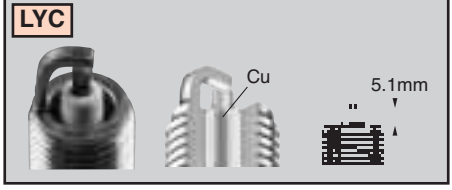
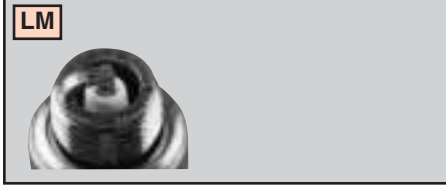
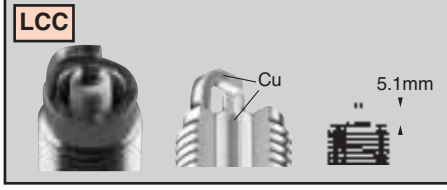
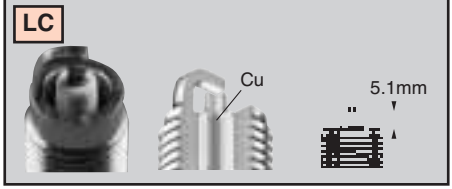
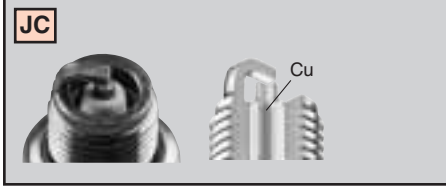
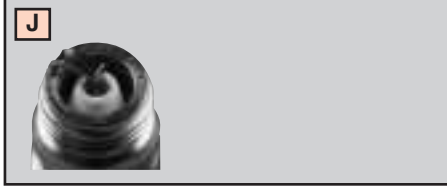
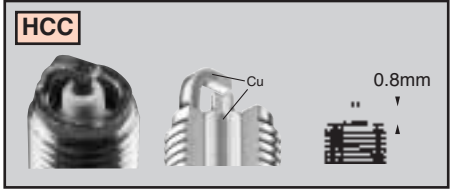
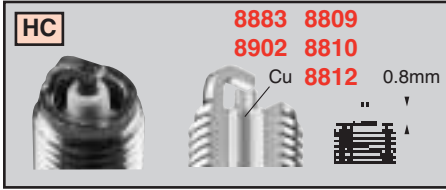
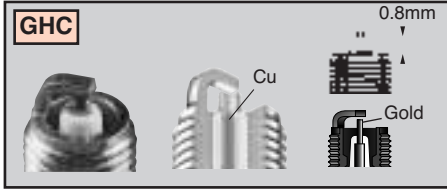
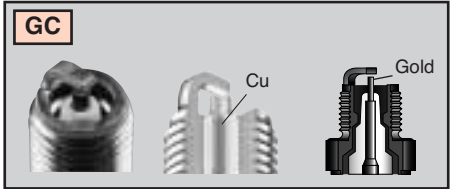
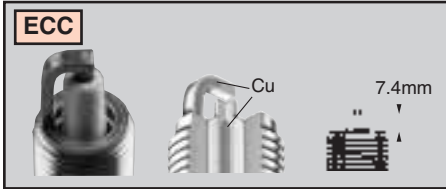
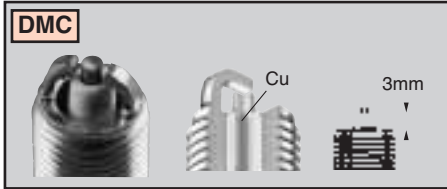
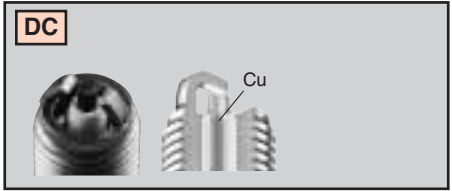
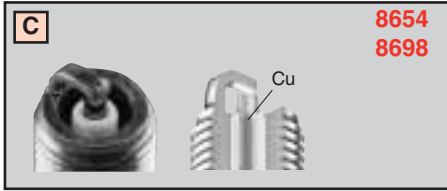
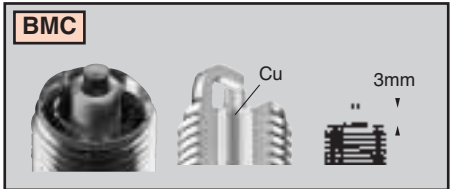
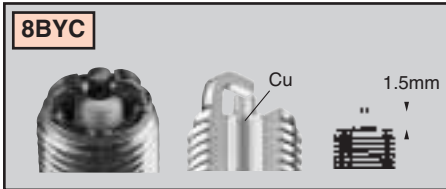
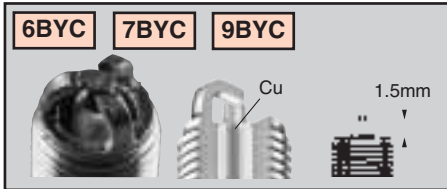

R C 7 YCC 4

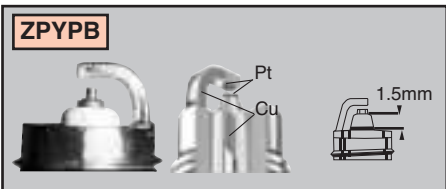
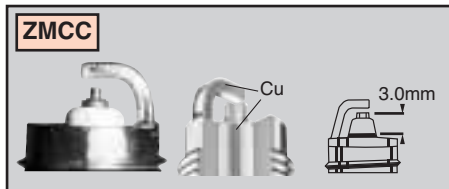
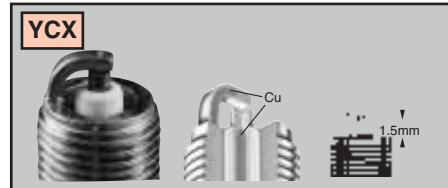
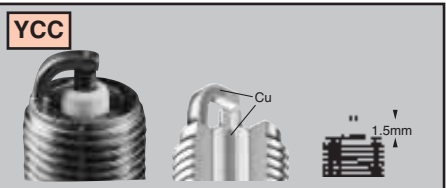
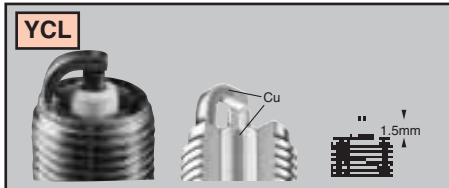
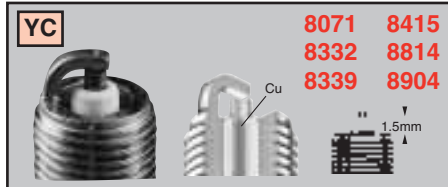
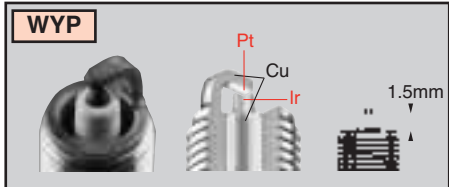
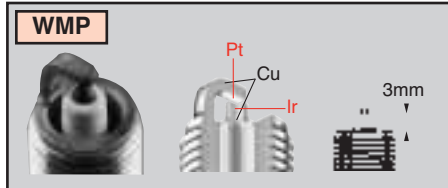
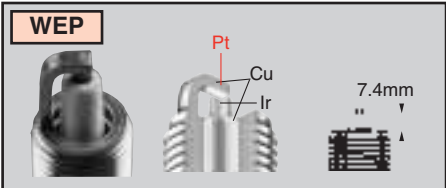
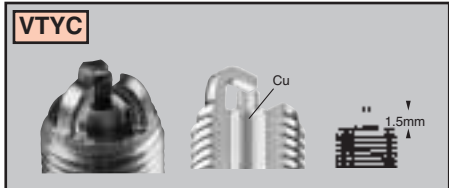
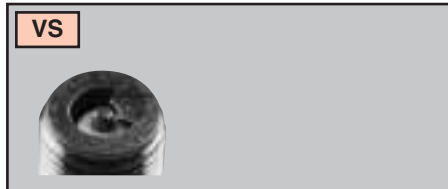
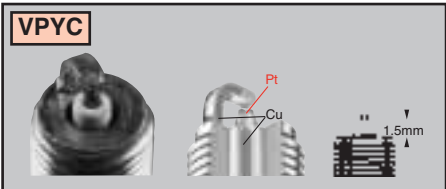
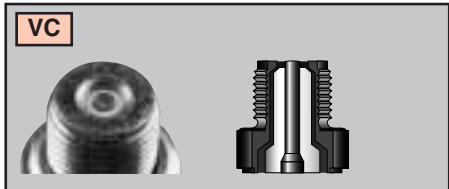
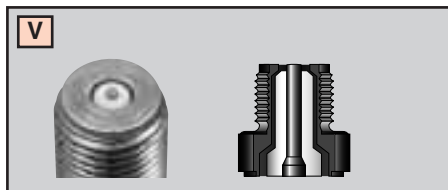
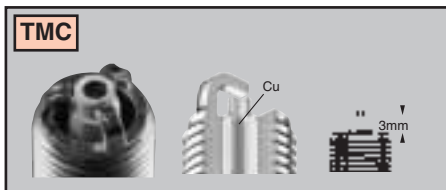
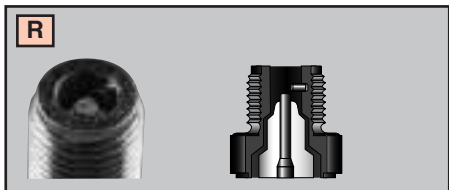
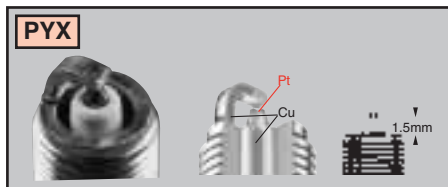
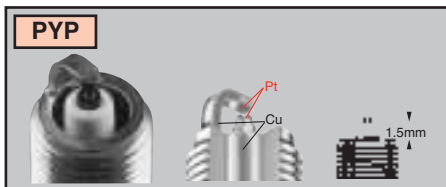
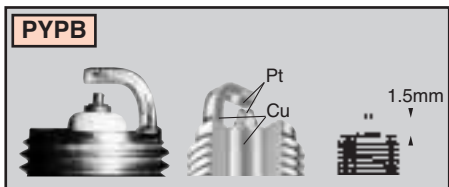

R C 7 YCC 4

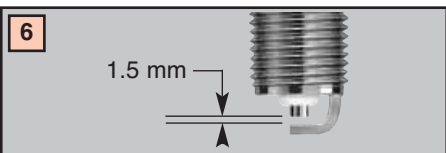
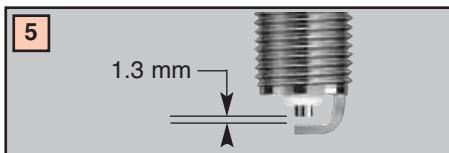
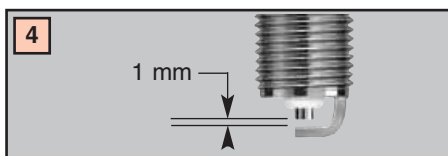
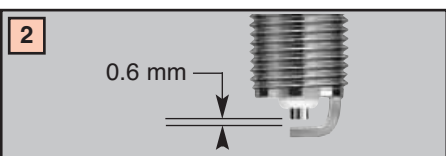
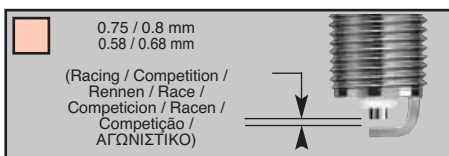



AC	CHAMPION	...AC	CHAMPION	...AC	CHAMPION	...AC	CHAMPION
41-907	OE039	45FFS	L92YC	FR1LS	RC9YC	R44CXL	RN11YC
41-907	RC9YC4	45FFS	OE059	FR1LS	RC9YC4	R44CXL	RN14YC
41-913	OE039	45NS	RN14YC	FR2CLS	OE005	R44F	L86C
41-913	RC9YC4	45XL	N5C	FR2CLS	RC9YC	R44F	OE037
41-954	OE031	45XL	OE074	FR2LS	OE005	R44LTS	RS14YC
41-954	RES9YCC4	45XLS	RN14YC	FR2LS	RC9YC	R44N	RN5C
41CXLS	N7YC	46F	L86C	FR3CLS	OE013	R44NS	OE042
41CXLS	OE010	46F	OE037	FR3CLS	RC12YC	R44NS	RN12YC
41XL	N2C	46FFS	L92YC	FR3LS	OE013	R44NS	RN14YC
41XL	OE040	46FFS	OE059	FR3LS	RC12YC	R44XL	RN5C
41XLS	N9YC	46N	N5C	FR5LS	OE013	R44XLS	RN14YC
41XLS	OE001	46N	OE074	FR5LS	RC12YC	R44XLSE	OE156
42	L82C	46TS	RV17YC	M42FF	L82C	R44XLSE	RN13LYC
42-6FS	L87YC	46XL	N5C	M43FF	L86C	R44XLSM	OE156
42-6FS	OE007	46XL	OE074	M43FF	OE037	R44XLSM	RN13LYC
42CF	L86C	46XLS	RN14YC	M43FF	RL86C	R45	RJ8C
42CF	OE037	47XL	N5C	M43S	J12YC	R45LS	RH10C
42CXLS	N9YC	47XL	OE074	M45FF	L86C	R45LTS6	RS14YC6
42CXLS	OE001	440XLS	N6YC	M45FF	OE037	R45NS	OE042
42FS	L82YC	440XLS	OE087	MR42FF	OE086	R45NS	RN12YC
42FS	OE038	B44S	J12YC	MR42FF	RL82C	R45NS	RN14YC
42S	J12YC	C41CXLS	N6YC	MR43FF	L86C	R45XL	RN5C
42XL	N3C	C41CXLS	N7YC	MR43FF	OE037	R45XLS	RN14YC
42XL	OE068	C41CXLS	OE010	MR44C	RJ6C	R46LTS	RS14YC
42XLS	N9YC	C41CXLS	OE087	R41CF	RL78C	R46N	N5C
42XLS	N11YC	C42CXLS	N9YC	R41CLS	OE018	R46N	OE074
42XLS	OE001	C42CXLS	OE001	R41CLS	RN7YC	R46S	RJ18YC
42XLS	OE065	C42N	N4C	R41CXL	OE091	R46TS	RV17YC
43CLS	N11YC	C42N	OE079	R41CXL	RN2C	R46XL	N5C
43CLS	OE065	C43N	N5C	R41CXLS	OE018	R46XL	OE074
43CXLS	N11YC	C43N	OE074	R41CXLS	RN7YC	R46XLS	RN14YC
43CXLS	OE065	C44N	N5C	R41XL	OE091	R47S	RJ18YC
43FS	L87YC	C44N	OE074	R41XL	RN2C	R47SX	RJ18YC
43FS	OE007	C44NS	N11YC	R41XLS	OE018	R84TS	RF11YC
43N	N4C	C44NS	OE065	R41XLS	RN7YC	R84TSX	RF11YC
43N	N5C	C44NS	RN14YC	R42CF	OE086	R85TS	RF14YC
43N	OE074	C44S	J12YC	R42CF	RL82C	R86TS	RF14YC
43N	OE079	C44XL	N4C	R42CFS	OE064	S40F	L82C
43S	J12YC	C44XL	N5C	R42CFS	RL82YC	S41XL	N2C
43XL	N4C	C44XL	OE074	R42CXL	OE098	S41XL	OE040
43XL	N5C	C44XL	OE079	R42CXL	OE108	S41XLR	OE091
43XL	OE074	C75	W14	R42CXL	RN3C	S41XLR	RN2C
43XL	OE079	C82	D9	R42CXL	RN4C	S42F	L82C
43XLS	N9YC	C83	D9	R42CXLS	OE006	S42XL	N3C
43XLS	N12YC	C85TS	RF11YC	R42CXLS	RN9YC	S42XL	OE068
43XLS	OE001	C86	D14	R42F	OE086	S42XLR	OE108
43XLS	OE015	CFR1CLS(black)	OE043	R42F	RL82C	S42XLR	RN3C
44CF	L86C	CFR1CLS(black)	RC7YC	R42XL	OE108	S43XL	N5C
44CF	OE037	CFR2CLS	OE043	R42XL	RN3C	S43XL	OE074
44F	L86C	CFR2CLS	RC7YC	R42XLS	OE006	S43XLR	RN5C
44F	OE037	CFR2CLS(black)	OE005	R42XLS	RN9YC	S44F	L86C
44FFS	L92YC	CFR2CLS(black)	RC9YC	R42XLS6	OE006	S44F	OE037
44FFS	OE059	CR42N	OE098	R42XLS6	OE048	S44XL	N5C
44N	N5C	CR42N	RN4C	R42XLS6	RN9YC	S44XL	OE074
44N	OE074	CR43	RJ6C	R42XLS6	RN9YC4	S45F	L86C
44NS	N12YC	CR43CXLS	OE051	R43	RJ6C	S45F	OE037
44NS	OE015	CR43CXLS	RN11YC	R43C	RJ6C	S82F	D9
44NS	RN14YC	CR43K	RJ6C	R43CXL	OE098	S83F	D9
44S	J12YC	CR43L	RH8C	R43CXL	RN4C	S85F	D14
44XL	N5C	CR43N	OE098	R43CXL	RN5C	S408XLG	C59R
44XL	OE074	CR43N	RN4C	R43CXLS	OE049	S438XLS	N6YC
44XLO	N12YC	CR43N	RN5C	R43CXLS	RN11YC4	S438XLS	OE087
44XLO	OE015	CR44N	RN5C	R43XL	RN5C		
44XLO	RN14YC	CR44NS	N11YC	R43XLS	OE042		
44XLS	N12YC	CR44NS	OE065	R43XLS	RN12YC		
44XLS	OE015	CR44NS	RN14YC	R44	RJ8C		
44XLS	RN14YC	CR45	RH10C	R44CF	RL86C		
45F	L86C	FR1LS	OE005	R44CXL	RN5C		
45F	OE037	FR1LS	OE039	R44CXLS	OE051		
						ALM	CHAMPION
						ALM 8	CJ8



AUTOLITE		...AUTOLITE		...BERU		...BERU	
51	N6YC	2614	OE040	14-6DU	N7YC	14FR-7DU	RC9YC
51	N6YCC	2615	N4C	14-6DU	N9YC	14FR-7DUX	OE039
51	OE084	2615	OE079	14-6DU	OE001	14FR-7DUX	RC9YC4
51	OE087	2616	N5C	14-6DU	OE010	14FR-7KDU	OE026
52	N7YC	2616	OE074	14-7AU	L86C	14FR-7KDU	RC8DMC
52	OE010	2656	L86C	14-7AU	OE037	14FR-7LDU	OE026
53	N9YC	2656	OE037	14-7BU	L87YC	14FR-7LDU	RC8DMC
53	OE001	2755	OE083	14-7BU	L92YC	14FR-8DU	OE013
54	N11YC	2755	RA6HC	14-7BU	OE007	14FR-8DU	RC12YC
54	OE065	3176	N5C	14-7BU	OE059	14KR-8MUV	OE031
55	N12YC	3176	OE074	14-7CU	N4C	14KR-8MUV	RES9YCC4
55	OE015	3922	OE039	14-7CU	N5C	14R-5DU	OE116
56	RN14YC	3922	RC9YC4	14-7CU	OE074	14R-5DU	RN6YC
57	RN14YC	3923	OE039	14-7CU	OE079	14R-6DU	OE008
63	OE006	3923	RC9YC4	14-7DU	N9YC	14R-6DU	OE018
63	RN9YC	3924	OE013	14-7DU	OE001	14R-6DU	RN7YC
64	OE049	3924	RC12YC	14-8A	L86C	14R-6DU	RN7YCC
64	RN11YC4	4054	N2C	14-8A	OE037	14R-7BU	OE064
65	OE042	4054	OE040	14-8AU	L86C	14R-7BU	RL82YC
65	RN12YC	4055	N3C	14-8AU	OE037	14R-7CU	OE098
66	RN14YC	4055	OE068	14-8B	L92YC	14R-7CU	RN4C
67	RN14YC	4056	N4C	14-8B	OE059	14R-7DU	OE004
106	RS14YC	4056	OE079	14-8BU	L92YC	14R-7DU	OE006
273	L82YC	4114	L87YC	14-8BU	OE059	14R-7DU	RN9YC
273	OE038	4114	OE007	14-8C	N5C	14R-7DU	RN9YCC
274	L87YC	4132	OE083	14-8C	OE074	14R-7DUX	OE048
274	OE007	4132	RA6HC	14-8DU	N11YC	14R-7DUX	RN9YC4
393	N3C	4133	OE083	14-8DU	N12YC	14R-8DU	OE006
393	N4C	4133	RA6HC	14-8DU	OE015	14R-8DU	OE042
393	OE068	4163	OE083	14-8DU	OE065	14R-8DU	OE051
393	OE079	4163	RA6HC	14-8 LUR	OE060	14R-8DU	RN9YC
394	N5C	4164	OE083	14-8 LUR	RN9LCC	14R-8DU	RN11YC
394	OE074	4164	RA6HC	14-9DU	N11YC	14R-8DU	RN12YC
395	N5C	4253	N9YC	14-9DU	OE065	14R-8DU4	OE004
395	OE074	4253	OE001	14A	L82YC	14R-8DU4	RN9YCC
396	N5C	4265	OE042	14A	L87YC	14R-8DUX	OE049
396	OE074	4265	RN12YC	14A	OE007	14R-8DUX	RN11YC4
397	N5C	5224	OE013	14A	OE038	14R-9DU	OE042
397	OE074	5224	RC12YC	14F-5DU	C6YCC	14R-9DU	OE045
402	OE091			14F-5DU	C7YC	14R-9DU	RN11YCC
402	OE108			14F-5DU	OE017	14R-9DU	RN12YC
402	RN2C	BERU		14F-5DU	OE075	14Z-3CU	N2C
402	RN3C	12-5DU	OE083	14F-6DU	C7YC	14Z-3CU	N3C
403	OE098	12-5DU	RA6HC	14F-6DU	OE017	14Z-3CU	OE040
403	OE108	14-10A	L86C	14F-6DUOR	OE043	14Z-3CU	OE068
403	RN3C	14-10A	OE037	14F-6DUOR	RC7YC	14Z-3CU	OE108
403	RN4C	14-10B	L92YC	14F-7DU	C9YCC	14Z-3CU	RN3C
404	OE098	14-10B	OE059	14F-7DU	OE023	14Z-4AU	L82C
404	RN4C	14-10DU	N12YC	14F-7DUO	C9YCC	18-4A1	D9
404	RN5C	14-10DU	OE015	14F-7DUO	OE023	18-5A	D9
405	RN5C	14-10DU	OE015	14F-7LDUR	OE026	18-7A	D9
406	RN5C	14-4A1	L82C	14F-7LDUR	RC8DMC	18-8A	D14
414	L86C	14-5A	L82C	14F-7LDUR4	OE026	95/14	L92YC
414	OE037	14-5AU	OE086	14F-7LDUR4	RC8DMC	95/14	OE059
415	L86C	14-5AU	RL82C	14F-9DUO	OE013	145	L86C
415	OE037	14-5BU	L82YC	14F-9DUO	RC12YC	145	OE037
417	L86C	14-5BU	OE038	14FR-5DTU	OE043	145/14	L86C
417	OE037	14-5D	N6YC	14FR-5DTU	RC7YC	145/14	OE037
535	L86C	14-5D	OE087	14FR-6DU	OE005	145/14/3	N5C
535	OE037	14-5DTU	N6BYC	14FR-6DU	OE014	145/14/3	OE074
766	RS14YC	14-5DTU	OE109	14FR-6DU	OE043	145/18	D14
767	RS14YC	14-5DU	N6YC	14FR-6DU	RC7YC	145/3	N5C
893	N9YC	14-5DU	OE087	14FR-6DU	RC7YCC	145/3	OE074
893	OE001	14-5DUO	N6YCC	14FR-6DU	RC9YC	175	L86C
2594	N3C	14-5DUO	OE084	14fr-6ldu	OE021	175	L87YC
2594	OE068	14-6BU	L82YC	14FR-6LDU	OE026	175	OE007
2612	N2C	14-6BU	OE038	14fr-6ldu	RC7BMC	175	OE037
2612	OE040	14-6DTU	N6BYC	14FR-6LDU	RC8DMC	175/14	L86C
2614	N2C	14-6DTU	OE109	14FR-7DU	OE005	175/14	OE037





...BERU	CHAMPION	BOSCH	CHAMPION	...BOSCH	CHAMPION	...BOSCH	CHAMPION
175/14A	L87YC	DR9BC	RF11YC	HR8MEV	RES9YCC4	W7DCR	RN9YC
175/14A	OE007	DR10BC	RF11YC	HR9DCY	RS14YC6	W7DCX	N9YC
175/18	D9	F03DAR	OE005	M4AC	D6	W7DCX	OE001
175/3A	N9YC	F03DAR	RC9YC	M5AC	D9	W7EC	J8C
175/3A	OE001	F04DAR	OE013	M7AC	D9	W7FC	J12YC
200/3A	N7YC	F04DAR	RC12YC	M8AC	D14	W8AC	L86C
200/3A	OE010	F5DC	C6YCC	UR2CC	OE092	W8AC	OE037
225	L82YC	F5DC	OE075	UR2CC	RG4HC	W8BC	L92YC
225	OE038	F6DC	C7YC	UR3AS	RZ96C	W8BC	OE059
225/14	L82C	F6DC	OE017	UR5DC	RG6YC	W8CC	N5C
225/14A	L82YC	F6DCOR	OE043	UR6DE	OE092	W8CC	OE074
225/14A	OE038	F6DCOR	RC7YC	UR6DE	RG4HC	W8DC	N11YC
225/3A	N6YC	F7DC	C9YCC	W2CC	N2C	W8DC	OE045
225/3A	OE087	F7DC	OE023	W2CC	OE040	W8DC	OE065
260/14	L82C	F7LDCR	OE026	W3AC	L77JC4	W8DC	RN11YCC
260/14/3S	C59R	F7LDCR	RC8DMC	W3CC	N2C	W8DCO	N9YC
S5	N7YC	F8LCR	C9YCC	W3CC	OE040	W8DCO	OE001
S5	OE010	F8LCR	OE023	W3CP	N2G	W8FC	J12YC
S7	N7YC	FR5DTC	OE026	W3CP	OE125	W8LCR	OE060
S7	OE010	FR5DTC	RC8DMC	W3D	N6YC	W8LCR	RN9LCC
Z1	N11YC	FR6DC	C7YC	W3D	OE087	W9AC	L86C
Z1	OE065	FR6DC	OE017	W3DP	N6YC	W9AC	OE037
Z3	OE060	FR6DC	OE043	W3DP	OE087	W9ACO	L86C
Z3	RN9LCC	FR6DC	RC7YC	W3DP0	N6YC	W9ACO	OE037
Z8	OE051	FR6DC+	OE043	W3DP0	OE087	W9CC	N5C
Z8	RN11YC	FR6DC+	RC7YC	W3DP2	N6YCC	W9CC	OE074
Z9	OE048	FR6DC2	OE014	W3DP2	OE084	W9DC	N11YC
Z9	RN9YC4	FR6DC2	RC7YCC	W4AC	L82C	W9DC	N12YC
Z10	L82YC	FR6DDC	OE026	W4CC	N3C	W9DC	OE015
Z10	OE038	FR6DDC	RC8DMC	W4CC	OE068	W9DC	OE065
Z11	OE006	FR6DTCW	OE077	W4CP	N3G	W9LC	N12YC
Z11	RN9YC	FR6DTCW	RC7BYC4	W4CP	OE078	W9LC	OE015
Z14	OE026	FR6KDC	OE014	W4CS	N3G	W10AC	L86C
Z14	RC8DMC	FR6KDC	RC7YCC	W4CS	OE078	W10AC	OE037
Z16	OE039	FR6LDC	OE021	W4DP0	N3G	W10D	N12YC
Z16	RC9YC4	FR6LDC	RC7BMC	W4DP0	OE078	W10D	OE015
Z20	OE006	FR7DC	C9YCC	W5AC	L82C	W10DC	N12YC
Z20	RN9YC	FR7DC	OE005	W5BC	L82YC	W10DC	OE015
Z23	OE043	FR7DC	OE023	W5BC	OE038	W10DCX	N12YC
Z23	RC7YC	FR7DC	RC9YC	W5CC	N3C	W10DCX	OE015
Z24	OE014	FR7DC+	OE005	W5CC	OE068	W10FC	J12YC
Z24	RC7YCC	FR7DC+	RC9YC	W5CS	N3G	WC7D	OE045
Z27	OE018	FR7DCX	OE039	W5CS	OE078	WC7D	RN11YCC
Z27	RN7YC	FR7DCX	RC9YC4	W5DC	N6YC	WR3CC	OE091
Z42	N6YC	FR7DCX+	OE039	W5DC	N6YCC	WR3CC	RN2C
Z42	OE087	FR7DCX+	RC9YC4	W5DC	OE084	WR4AC	OE086
Z45	OE043	FR7DPP332	OE079	W5DC	OE087	WR4AC	RL82C
Z45	RC7YC	FR7DPP332	RC8WYP4	W5DP0	N3C	WR4CC	OE108
Z60	OE021	FR7LDC	OE026	W5DP0	OE068	WR4CC	RN3C
Z60	RC7BMC	FR7LDC	RC8DMC	W5DTC	N6BYC	WR5AC	OE086
Z79	OE013	FR7LDC+	OE026	W5DTC	OE109	WR5AC	RL82C
Z79	RC12YC	FR7LDC+	RC8DMC	W6BC	L82YC	WR5CC	OE108
Z98	OE026	FR8DC	OE013	W6BC	OE038	WR5CC	RN3C
Z98	RC8DMC	FR8DC	RC12YC	W6DC	N7YC	WR5DC	OE116
Z99	OE039	FR8DPX	OE013	W6DC	OE010	WR5DC	RN6YC
Z99	RC9YC4	FR8DPX	RC12YC	W6DTC	N6BYC	WR5DC+	OE116
Z116	OE026	FR8KCU	OE039	W6DTC	OE109	WR5DC+	RN6YC
Z116	RC8DMC	FR8KCU	RC9YC4	W7AC	L86C	WR5DP	OE116
Z119	OE004	FR8KDC	OE026	W7AC	OE037	WR5DP	RN6YC
Z119	RN9YCC	FR8KDC	RC8DMC	W07AS	QL55	WR5DS	OE116
Z123	OE026	FR9DC	OE013	W7BC	L87YC	WR5DS	RN6YC
Z123	RC8DMC	FR9DC	RC12YC	W7BC	OE007	WR6BC	OE064
		FR10DC	OE013	W7CC	N4C	WR6BC	RL82YC
		FR10DC	RC12YC	W7CC	N5C	WR6DC	OE008
		HR8DCX	RS14YC6	W7CC	OE074	WR6DC	OE018
		HR8DCY	RS14YC6	W7CC	OE079	WR6DC	RN7YC
		HR8MVC+	OE031	W7DC	N9YC	WR6DC	RN7YCC
		HR8MVC+	RES9YCC4	W7DC	OE001	WR6DC+	OE018
		HR8MEV	OE031	W7DCR	OE006	WR6DC+	RN7YC



...BOSCH	CHAMPION	...BOSCH	CHAMPION	...DENSO	CHAMPION	...DENSO	CHAMPION
WR6DC2	OE008	WR11F	RJ14YC	IU24	OE122	U22FS-U	RZ96C
WR6DC2	RN7YCC	WR78	OE006	IU24	RG4PHP	U24ESR-N	8698
WR6DP	OE018	WR78	RN9YC	J16CRU	OE060	U24ESR-N	RG94C
WR6DP	RN7YC	WR78G	OE064	J16CRU	RN9LCC	U24ESR-NB	RG94C
WR6FC	RJ6C	WR78G	RL82YC	K16PRU	OE013	U24ESRNZU	OE122
WR7AC	RL86C	WR78X	OE004	K16PRU	RC12YC	U24ESRNZU	RG4PHP
WR7BC	OE064	WR78X	RN9YCC	K16TNR59	OE026	U24FER9	RGU94C
WR7BC	RL82YC	WR91X	OE004	K16TNR59	RC8DMC	U24FSR-U	RZ94C
WR7BC+	OE064	WR91X	RN9YCC	K20TXR	OE026	U27ESR-N	8654
WR7BC+	RL82YC	WS8F	CJ8Y	K20TXR	RC8DMC	U27ETR	8654
WR7CC	OE098	WSR6F	RCJ6Y	K22PBR7	OE077	VK20	OE179
WR7CC	RN4C	X4C	OE083	K22PBR7	RC7BYC4	VK20	RC8WYP4
WR7DC	OE006	X4C	RA6HC	k22pbrs	OE021	VK20G	OE179
WR7DC	RN9YC	X5DC	A6HC	K22PBR5	OE077	VK20G	RC8WYP4
WR7DC+	OE006	X5DC	OE132	k22pbrs	RC7BMC	VK20PRZ11	OE179
WR7DC+	RN9YC	X5DTC	A6HC	K22PBR5	RC7BYC4	VK20PRZ11	RC8WYP4
WR7DC2	OE004	X5DTC	OE132	K22TNR5	OE021	W9EXRU	RN14YC
WR7DC2	RN9YCC	XR2CS	OE073	K22TNR5	RC7BMC	W9EXU	RN14YC
WR7DCX	OE048	XR2CS	RA4HC	KJ20DRM11	OE026	W14EPRU	OE042
WR7DCX	RN9YCC	XR3CPO	A59GC	KJ20DRM11	RC8DMC	W14EPRU	RN12YC
WR7DCX+	OE048	XR3CPO	OE103	M14	D14	W14EPU	N12YC
WR7DCX+	RN9YCC	XR5DC	OE073	M17	D14	W14EPU	OE015
WR7DP	OE006	XR5DC	RA4HC	M22	D9	W14EXRU	OE042
WR7DP	RN9YC	Y5DDC	A59GC	M24S	D6	W14EXRU	RN12YC
WR7DS	OE006	Y5DDC	OE103	P16R	OE042	W14EXU	N12YC
WR7DS	RN9YC	Y6DC	A6HC	P16R	RN12YC	W14EXU	OE015
WR7LC	OE060	Y6DC	OE132	P20PR8	OE018	W14FPUL	L92YC
WR7LC	RN9LCC	YR5DDE	OE073	P20PR8	RN7YC	W14FPUL	OE059
WR8AC	L86C	YR5DDE	RA4HC	P20R11	OE048	W14FRU	RL86C
WR8AC	OE037	YR7DE	OE052	P20R11	RN9YCC	W14FU	L86C
WR8BC	L92YC	YR7DE	OE073	PQ16R	OE013	W14FU	OE037
WR8BC	OE059	YR7DE	RA4HC	PQ16R	RC12YC	W16EPRS11	OE049
WR8BC+	L92YC	YR7DE	RA4HCX	Q16PRU	OE013	W16EPRS11	RN11YCC
WR8BC+	OE059			Q16PRU	RC12YC	W16EPRU	OE042
WR8CC	RN5C			Q16RU	OE013	W16EPRU	OE045
WR8DC	OE045			Q16RU	RC12YC	W16EPRU	OE051
WR8DC	OE051	BOSNA	CHAMPION	Q20PRU	OE005	W16EPRU	RN11YC
WR8DC	RN11YC	F.85	L82YC	Q20PRU	RC9YC	W16EPRU	RN11YCC
WR8DC	RN11YCC	F.85	L86C	Q20PRU11	OE039	W16EPRU	RN12YC
WR8DC+	OE051	F.85	OE037	Q20PRU11	RC9YCC	W16EPRU10	OE049
WR8DC+	RN11YC	F.85	OE038	Q20PU	C9YCC	W16EPRU10	RN11YCC
WR8DC04	OE048			Q20PU	OE023	W16EPRU11	OE049
WR8DC04	RN9YCC			Q20PU11	OE039	W16EPRU11	RN11YCC
WR8DCX	OE049	BRISK	CHAMPION	Q20PU11	RC9YCC	W16EPU	N11YC
WR8DCX	RN11YCC	DR15YC	OE005	Q20RU11	OE039	W16EPU	N12YC
WR8DCX+	OE049	DR15YC	RC9YC	Q20RU11	RC9YCC	W16EPU	OE015
WR8DCX+	RN11YCC	DR15YC1	OE039	Q22PRU	OE014	W16EPU	OE065
WR8DP	OE051	DR15YC1	RC9YCC	Q22PRU	OE043	W16ESL	N11YC
WR8DP	RN11YC			Q22PRU	RC7YC	W16ESL	OE065
WR8EC	RJ8C			Q22PRU	RC7YCC	W16ESRL	OE051
WR8LC	OE051			Q22PU	C6YCC	W16ESRL	RN11YC
WR8LC	RN11YC	DENSO	CHAMPION	Q22PU	C7YC	W16ESRL11	OE049
WR8LC+	OE051	D2	OE006	Q22PU	OE017	W16ESRL11	RN11YCC
WR8LC+	RN11YC	D2	RN9YC	Q22PU	OE075	W16ESRU	RN5C
WR8LP	OE051	D4	N9YC	Q22PU	OE179	W16ESU	N5C
WR8LP	RN11YC	D4	OE001	SK20PRA8	RC8WYP4	W16ESU	OE074
WR9DC	OE042	D4	N12YC	SKJ20DRM11	OE179	W16EXRU	OE051
WR9DC	RN12YC	D8	OE015	SKJ20DRM11	RC8WYP4	W16EXRU	RN11YC
WR9DC+	OE042	D8	OE005	SKJ20DRM11S	OE179	W16EXRU11	OE049
WR9DC+	RN12YC	D12	OE005	SKJ20DRM11S	RC8WYP4	W16EXRU11	RN11YCC
WR9DCX	OE042	D12	RC9YC	SVK20RZ8	OE179	W16EXRU13	OE049
WR9DCX	RN12YC	D12	OE179	SVK20RZ8	RC8WYP4	W16EXRU13	RN11YCC
WR9DX	OE042	IK20	RC8WYP4	T16VRU10	OE031	W16EXRUA	OE051
WR9DX	RN12YC	IK20	OE179	T16VRU10	RES9YCC4	W16EXRUA	RN11YC
WR9HC	OE156	IK20G	RC8WYP4	U20EPR9	OE092	W16EXU	N11YC
WR9HC	RN13LYC	IK20G	OE179	U20EPR9	RG4HC	W16EXU	OE065
WR10LC	OE042	IK22	RC8WYP4	U22ESRN	RG96C	W16EXU13	OE049
WR10LC	RN12YC	IK22	OE179	U22ESR-N	8698	W16EXU13	RN11YCC
WR11EO	RJ8C	IU22	OE122	U22FSR-U	RZ96C	W16FPU	L92YC
		IU22	RG4PHP				



...DENSO	CHAMPION	...DENSO	CHAMPION	...DENSO	CHAMPION	...EYQUEM	CHAMPION
W16FPU	OE059	W22EPRS11	RN11YC4	W27ESZU	OE125	705S	OE007
W16FSR	RL86C	W22EPRU	OE008	WU9EU	N5C	707LS	N9YC
W16FSU	L86C	W22EPRU	OE018	WU9EU	OE074	707LS	OE001
W16FSU	OE037	W22EPRU	RN7YC	WU14EU	N5C	755	L82C
W17ESU	N5C	W22EPRU	RN7YCC	WU14EU	OE074	755L	N4C
W17ESU	OE074	W22EPU	L82YC	X20ESU	RA8HC	755L	OE079
W17EWU	N9YC	W22EPU	N7YC	X20EU	RA8HC	755LS	N9YC
W17EWU	OE001	W22EPU	OE010	X22EPR-U9	8812	755LS	OE001
W17FU	L86C	W22EPU	OE038	X22EPRZU9	RA8HC	755SX	L82YC
W17FU	OE037	W22EPZU	N3C	X22EPU9	OE083	755SX	OE038
W20EKPRS11	OE006	W22EPZU	OE068	X22EPU9	RA6HC	755X	L82C
W20EKPRS11	RN9YC	W22ESL	N7YC	X22EPZU9	RA8HC	800LS	N7YC
W20EKRS11	OE006	W22ESL	OE010	X22ESR-U	8812	800LS	OE010
W20EKRS11	RN9YC	W22ESL11	N9YC	X22ESU	RA8HC	805L	N3C
W20EPRU10	OE048	W22ESL11	OE001	X22EU	RA8HC	805L	OE068
W20EPRU10	RN9YC4	W22ESRL	OE018	X22SZU	RA8HC	805LP	N3G
W20EPRU11	OE048	W22ESRL	RN7YC	X24EPR-U9	8809	805LP	OE078
W20EPRU11	RN9YC4	W22ESRU	OE098	X24EPRZU9	OE083	850	L82C
W20EPU	L87YC	W22ESRU	RN4C	X24EPRZU9	RA6HC	850LS	N6YC
W20EPU	N9YC	W22ESU	N3C	X24EPZU9	OE083	850LS	OE087
W20EPU	OE001	W22ESU	N4C	X24EPZU9	RA6HC	1000L	N2C
W20EPU	OE007	W22ESU	OE068	X24ESR-U	8809	1000L	OE040
W20EPZU	N4C	W22ESU	OE079	X24ESU	A6HC	4065	L86C
W20EPZU	OE079	W22ESZU	N3C	X24ESU	OE132	4065	OE037
W20ESL	N9YC	W22ESZU	OE068	X24ESZU	A6GC	C32LS	N12YC
W20ESL	OE001	W22EU	N5C	X24ESZU	OE083	C32LS	OE015
W20ESL11	N7YC	W22EU	OE074	X24ESZU	OE112	C42S	L87YC
W20ESL11	OE010	W22EXRU	OE018	X24ESZU	RA6HC	C42S	OE007
W20ESRL	OE006	W22EXRU	RN7YC	X27EPR-U9	8809	C52LS	N9YC
W20ESRL	RN9YC	W22EXU	N7YC	X27EPR-U9	RAX92YC	C52LS	OE001
W20ESRL11	OE048	W22EXU	OE010	X27EPRZU9	OE083	C62LS	N7YC
W20ESRL11	RN9YC4	W22FPRU	OE064	X27EPRZU9	RA6HC	C62LS	OE010
W20ESRU	RN5C	W22FPRU	RL82YC	X27EPZU9	OE083	C72LS	N6YC
W20ESU	N5C	W22FPU	L82YC	X27EPZU9	RA6HC	C72LS	OE087
W20ESU	OE074	W22FPU	OE038	X27ESR-U	8809	C82LS	N6YC
W20ESZU	N4C	W22FRU	L82YC	X27ESR-U	RAX92C	C82LS	OE087
W20ESZU	OE079	W22FRU	OE038	X27ESZU	A59GC	FC52LS	C9YCC
W20ETRS	OE006	W22FSR	OE086	X27ESZU	OE083	FC52LS	OE023
W20ETRS	RN9YC	W22FSR	RL82C	X27ESZU	OE103	FC58LS	C7YC
W20ETS	N9YC	W22FSRU	OE086	X27ESZU	RA6HC	FC58LS	OE017
W20ETS	OE001	W22FSRU	RL82C	X27ETR	8809	FC62LS3	OE021
W20EXRU	OE006	W22FSU	L82C	X27ETR	RAX92DC	FC62LS3	RC7BMC
W20EXRU	RN9YC	W22FSZU	L86C	X31ESZU	OE073	FC82LS	C6YCC
W20EXRU11	OE048	W22FSZU	OE037	X31ESZU	RA4HC	FC82LS	OE075
W20EXRU11	RN9YC4	W22FU	L86C	XU22EPRU	OE083	FN52LS	C9YCC
W20EXU	N9YC	W22FU	OE037	XU22EPRU	RA6HC	FN52LS	OE023
W20EXU	OE001	W22MPUS	CJ7Y	XU24EPRU	OE083	N43	OE064
W20EXU13	N9YC	W22MU	CJ6	XU24EPRU	RA6HC	N43	RL82YC
W20EXU13	OE001	W24EPRU	OE116	XU27EPRU	OE073	RC32LS	OE051
W20FPRU	OE064	W24EPRU	RN6YC	XU27EPRU	RA4HC	RC32LS	RN11YC
W20FPRU	RL82YC	W24EPU	N6YC	XU27EPRZU	OE073	RC42S	OE064
W20FPU	L87YC	W24EPU	N6YCC	XU27EPRZU	RA4HC	RC42S	RL82YC
W20FPU	OE007	W24EPU	OE084			RC62LS	OE006
W20FP-U	L87YC	W24EPU	OE087			RC62LS	RN9YC
W20FP-U	OE007	W24ESRU	OE108			RC72LS	OE018
W20FSU	L86C	W24ESRU	RN3C			RC72LS	RN7YC
W20FSU	OE037	W24ESU	N3C			RFC50LZ2E	OE026
W20FSZU	L86C	W24ESU	OE068			RFC50LZ2E	RC8DMC
W20FSZU	OE037	W24ESZU	N3G			RFC52LS	OE005
W20FTU	L82YC	W24ESZU	OE078			RFC52LS	RC9YC
W20FTU	OE038	W24EU	N3C			RFC52LS2E	OE026
W20SRU	RJ6C	W24EU	OE068			RFC52LS2E	RC8DMC
W21ESL11	N7YC	W25EN	C59R			RFC58LS	OE043
W21ESL11	OE010	W27EN	C59R			RFC58LS	RC7YC
W21ESRL11	OE018	W27ESRU	OE091			RFC58LS3	OE021
W21ESRL11	RN7YC	W27ESRU	RN2C			RFC58LS3	RC7BMC
W22EPB	N6BYC	W27ESU	N2C			RFC58LZ2E	OE026
W22EPB	OE109	W27ESU	OE040			RFC58LZ2E	RC8DMC
W22EPRS11	OE049	W27ESZU	N2G			RFC62LS	OE014
				EYQUEM	CHAMPION		
				406	L86C		
				406	OE037		
				500	L86C		
				500	OE037		
				550S	L92YC		
				550S	OE059		
				580LS	N12YC		
				580LS	OE015		
				600LS	N11YC		
				600LS	OE065		
				705L	N5C		
				705L	OE074		
				705S	L87YC		



...EYQUEM

RFC62LS	RC7YCC
RFC72LS	OE094
RFC72LS	RC6YCC

HONDA

9807B-5615W	OE179
9807B-5615W	RC8WYP4
9807B-5617W	OE179
9807B-5617W	RC8WYP4
9807B-56A7W	OE179
9807B-56A7W	RC8WYP4

ISKRA

F.70/M75	L86C
F.70/M75	OE037
M.14-145	L86C
M.14-145	OE037
M.14-225	L82C

ISOLATOR

FM.14-125/2	N12YC
FM.14-125/2	OE015
FM.14-145/2	N11YC
FM.14-145/2	OE065
FM.14-175/2	N9YC
FM.14-175/2	OE001
M.14-125	L86C
M.14-125	OE037
M.14-145	L86C
M.14-145	OE037
M.14-175	L86C
M.14-175	OE037
M.14-225/2	N4C
M.14-225/2	OE079
M.14-240/2	N3C
M.14-240/2	OE068
PM.14-145	L92YC
PM.14-145	OE059
PM.14-200	L82YC
PM.14-200	OE038
PM.14-225	L82YC
PM.14-225	OE038

LODGE

2HL	N7YC
2HL	OE010
2HLDR	OE014
2HLDR	OE043
2HLDR	RC7YC
2HLDR	RC7YCC
2HLE	N4C
2HLE	N9YC
2HLE	OE001
2HLE	OE079
2HLN	N3C
2HLN	OE068
2HLNY	N7YC
2HLNY	OE010
3HLN	N2C
3HLN	OE040
3HLNY	N6YC

...LODGE

3HLNY	OE087
25HL	N6YC
25HL	OE087
25HLD	C6YCC
25HLD	OE075
25HLE	N6YC
25HLE	OE087
25HLNY	N7YC
25HLNY	OE010
HL	N9YC
HL	OE001
HLD	C9YCC
HLD	OE023
L6Y	N9YC
L6Y	OE001

MAGNETI MARELLI

7LC1R	OE039
7LC1R	RC9YC4
7LCR	OE005
7LCR	RC9YC
7LDC	C9YCC
7LDC	OE023
8LC	C7YC
8LC	OE017
8LCR	OE043
8LCR	RC7YC
9LC	C6YCC
9LC	OE075
CW5N	L86C
CW5N	OE037
CW6NP	L87YC
CW6NP	OE007
CW7NP	L82YC
CW7NP	OE038
CW7NPR	OE064
CW7NPR	RL82YC
CW8LPR	OE018
CW8LPR	RN7YC
CW8NP	L82YC
CW8NP	OE038
CW78LPR	OE018
CW78LPR	RN7YC
F4LC	N12YC
F4LC	OE015
F4LCR	OE042
F4LCR	RN12YC
F6NC	L87YC
F6NC	OE007
F7LC	N9YC
F7LC	OE001
F7LC1R	OE048
F7LC1R	RN9YC4
F7LCR	OE006
F7LCR	RN9YC
F7LDCR	OE004
F7LDCR	RN9YCC
F7NC	L82YC
F7NC	OE038
F7NCR	OE064
F7NCR	RL82YC
F8LC	N7YC
F8LC	OE010
F8LCR	OE018
F8LCR	RN7YC
F8LDCR	OE008
F8LDCR	RN7YCC

...MAGNETI MARELLI

F9LC	N6YC
F9LC	OE087
F9LDC	N6YCC
F9LDC	OE084
F9LDCR	OE094
F9LDCR	RC6YCC
F45LCR	OE051
F45LCR	RN11YC
F45LDCR	OE045
F45LDCR	RN11YCC
FC7N	L82C
FC7NR	OE086
FC7NR	RL82C
FL7LCR	OE006
FL7LCR	RN9YC
FL8LCR	OE018
FL8LCR	RN7YC
L7LCR	OE005
L7LCR	RC9YC
L7SCR	OE021
L7SCR	RC7BMC
L8LCR	OE043
L8LCR	RC7YC
L8LDCR	OE014
L8LDCR	RC7YCC
L10BPCPR	OE122
L10BPCPR	RG4PHP
L10CR	OE073
L10CR	RA4HC
L10DCR	OE052
L10DCR	RA4HCX
L75LSCR	OE026
L75LSCR	RC8DMC
V10CR	OE092
V10CR	RG4HC

MARCHAL

5H	N3C
5H	OE068
5N	L82YC
5N	OE038
6N	L86C
6N	OE037
9H	N9YC
9H	OE001
34HS	N3C
34HS	OE068
36	L86C
36	OE037
GT34/5HA	N9YC
GT34/5HA	OE001
GT35H	N9YC
GT35H	OE001

MOTORCRAFT

1Y00-18-110	OE051
1Y00-18-110	RN11YC
1Y01-18-110	OE006
1Y01-18-110	RN9YC
1Y03-18-110	OE049
1Y03-18-110	RN11YC4
1Y0F-18-110	OE083
1Y0F-18-110	RA6HC
1Y0K-18-110	OE049
1Y0K-18-110	RN11YC4

...MOTORCRAFT

1YRF-18-110	OE083
1YRF-18-110	RA6HC
AE4	L86C
AE4	OE037
AE4C	L86C
AE4C	OE037
AE4X	L86C
AE4X	OE037
AE6	L86C
AE6	OE037
AE8	L86C
AE8	OE037
AE22C	L82YC
AE22C	OE038
AE32	L87YC
AE32	OE007
AE32C	L82YC
AE32C	OE038
AE42	L92YC
AE42	OE059
AE62	L92YC
AE62	OE059
AER2X	OE086
AER2X	RL82C
AER22	OE086
AER22	RL82C
AG1C	N3C
AG1C	OE068
AG1CX	N3C
AG1CX	OE068
AG1X	N3C
AG1X	OE068
AG2	N4C
AG2	OE079
AG2C	N4C
AG2C	OE079
AG2X	N4C
AG2X	OE079
AG3	N5C
AG3	OE074
AG3C	N5C
AG3C	OE074
AG3X	N5C
AG3X	OE074
AG4	N5C
AG4	OE074
AG5	N5C
AG5	OE074
AG7	N5C
AG7	OE074
AG12	N7YC
AG12	OE010
AG12C	N7YC
AG12C	OE010
AG22	N9YC
AG22	OE001
AG22C	N9YC
AG22C	OE001
AG25	N9YC
AG25	OE001
AG32	N11YC
AG32	OE065
AG32A	N11YC
AG32A	OE065
AG32C	N9YC
AG32C	N11YC
AG32C	N12YC
AG32C	OE001
AG32C	OE015





...MOTORCRAFT	CHAMPION
AG32C	OE065
AG040	OE006
AG040	RN9YC
AG42	N12YC
AG42	OE015
AG42C	N12YC
AG42C	OE015
AG224	N9YC
AG224	OE001
AG701	N2C
AG701	OE040
AG901C	N3C
AG901C	OE068
AG902	N6YC
AG902	OE087
AGP12C	C7YC
AGP12C	OE017
AGPR12C	OE043
AGPR12C	RC7YC
AGPR22C	OE005
AGPR22C	RC9YC
AGPR22CD	OE043
AGPR22CD	RC7YC
AGPR32C1	OE043
AGPR32C1	RC7YC
AGPS22C	OE005
AGPS22C	RC9YC
AGPS22CD	OE043
AGPS22CD	RC7YC
AGR1X	OE108
AGR1X	RN3C
AGR2C	OE098
AGR2C	RN4C
AGR2X	OE098
AGR2X	RN4C
AGR3X	RN5C
AGR12	OE018
AGR12	RN7YC
AGR12C	OE018
AGR12C	RN7YC
AGR21	OE098
AGR21	RN4C
AGR22	OE006
AGR22	RN9YC
AGR22C	OE006
AGR22C	RN9YC
AGR31	RN5C
AGR32	OE049
AGR32	RN11YC4
AGR32C	OE006
AGR32C	OE042
AGR32C	OE051
AGR32C	RN9YC
AGR32C	RN11YC
AGR32C	RN12YC
AGR41	RN5C
AGR42	OE042
AGR42	RN12YC
AGR42C	OE042
AGR42C	RN12YC
AGS1C	OE108
AGS1C	RN3C
AGS2C	OE098
AGS2C	RN4C
AGS3C	RN5C
AGS4C	RN5C
AGS22C	OE006
AGS22C	RN9YC
AGS32C	OE042

...MOTORCRAFT	CHAMPION
AGS32C	RN12YC
AGS42C	OE042
AGS42C	RN12YC
AGSF32W	RS14YC6
AGSP33C	OE043
AGSP33C	RC7YC
AV4	L86C
AV4	OE037
AYFS22C	OE031
AYFS22C	RES9YCC4
AYFS32CJ	OE031
AYFS32CJ	RES9YCC4
AYRF22PP	OE031
AYRF22PP	RES9YCC4
AZFS22C	OE031
AZFS22C	RES9YCC4
NEWSTAR	
CHAMPION	
A6TC	Z6
A7TC	Z6
B7RC	OE092
B7RC	RG4HC
C6TC	P8Y
C8C	P7
C8RC	P7
D6TC	A6HC
D6TC	OE132
D8C	A6GC
D8C	OE112
D8RTC	OE083
D8RTC	RA6HC
D8TC	OE083
D8TC	RA6HC
DK7RTC	OE073
DK7RTC	RA4HC
E4C	L90C
E4RTC	RL95YC
E5C	L90C
E6C	L86C
E6C	OE037
E6RC	RL86C
E6TC	L92YC
E6TC	OE059
E7C	L86C
E7C	OE037
E7RC	RL86C
E7RTC	RL87YC
E7TC	L87YC
E7TC	OE007
E8C	L82C
E8RTC	OE064
E8RTC	RL82YC
E8TC	L82YC
E8TC	OE038
E9C	L82C
E9RC	OE086
E9RC	RL82C
E10C	UL81C
E11C	L78C
E12C	L77JC4
F5FC	OE156
F5FC	RN13LYC
F5LC	N12YC
F5LC	OE015
F5RFC	OE156
F5RFC	RN13LYC
F5RTC	OE042

...NEWSTAR	CHAMPION
F5RTC	RN12YC
F5RTC-15	OE042
F5RTC-15	RN12YC
F5TC	N11YC
F5TC	OE065
F6C	N5C
F6C	OE074
F6RC	RN5C
F6RTC	OE051
F6RTC	RN11YC
F6RTC-10	OE049
F6RTC-10	RN11YC4
F6TC	N11YC
F6TC	OE065
F6TC-10	N11YC
F6TC-10	OE065
F7C	N4C
F7C	OE079
F7RC	OE098
F7RC	RN4C
F7RLC	OE060
F7RLC	RN9LCC
F7RLC-10	OE060
F7RLC-10	RN9LCC
F7RTC	OE006
F7RTC	RN9YC
F7RTC-10	OE048
F7RTC-10	RN9YC4
F7TC	N9YC
F7TC	OE001
F8RTC	OE018
F8RTC	RN7YC
F8TC	N7YC
F8TC	OE010
F9C	N3C
F9C	OE068
F9RC	OE108
F9RC	RN3C
F9RTC	OE116
F9RTC	RN6YC
F9TC	N6YC
F9TC	OE087
F9TJC	N6BYC
F9TJC	OE109
F10RC	OE108
F10RC	RN3C
F11C	N2C
F11C	OE040
F11RC	OE091
F11RC	RN2C
G2RC	RJ12C
G4RTC	RJ14YC
G4RTC-15	RJ14YC
G4RTC-20	RJ14YC
G4TC	RJ14YC
G5C	J8C
G5RC	RJ8C
G6TC	J12YC
G7RC	RJ6C
G7TC	J12YC
G9C	J4C
GL3RC	RJ19LM
GL5RC	RJ17LM
K4RTC	RC14YC
K4RTC-10	RC14YC
K5RTC	OE013
K5RTC	RC12YC
K7RTC	OE005
K7RTC	RC9YC

...NEWSTAR	CHAMPION
K7RTC-10	OE039
K7RTC-10	RC9YC4
K8RTC	OE043
K8RTC	RC7YC
K8RTKC	OE021
K8RTKC	RC7BMC
K8TC	C7YC
K8TC	OE017
K9TC	C6YCC
K9TC	OE075
L2C	CJ14
L5C	CJ8
L6C	CJ6
L6RC	RCJ8
L6RTC	RCJ8Y
L6TC	CJ8Y
L7C	CJ6
L7RTC	RCJ7Y
L7TC	CJ7Y
L9RTC	RCJ6Y
P4RTC	RV17YC
P4RTC-10	RV17YC
P5RTC	RV15YC4
P5RTC-10	RV15YC4
P5TC	RV15YC4
Q5RTC	RS14YC
Q5RTC-15	RS14YC6
T4TC	RF14YC
T5RTC	RF11YC
T5RTC-10	RF11YC
T5TC	RF11YC
U4C	D16
U7C	D14
U9C	D14
U10C	D9
UK4C	D16
UK4RC	RD16
UK4TC	D16
UK6C	D14
UK6RC	D14
UK7C	D9
UK10C	D9
NGK	
CHAMPION	
A6	D14
A7	D14
A8	D9
APR5FS	RF11YC
B2	RJ12C
B4ES	N5C
B4ES	OE074
B4H	L90C
B5EB	N5C
B5EB	OE074
B5ES	N5C
B5ES	OE074
B5EV	N5C
B5EV	OE074
B5HS	L86C
B5HS	OE037
B6EB	N5C
B6EB	OE074
B6EBL	N5C
B6EBL	OE074
B6ES	N5C
B6ES	OE074
B6EV	OE098



...NGK	CHAMPION	...NGK	CHAMPION	...NGK	CHAMPION	...NGK	CHAMPION
B6EV	RN4C	B10HVX	QL55	BK7EKU	OE021	BP5ESA	OE015
B6HS	L86C	B85EGV	N2G	BK7EKU	RC7BMC	BP5ESZ	N11YC
B6HS	OE037	B85EGV	OE125	BKR4E	OE013	BP5ESZ	OE065
B6HS10	L86C	B95EGV	QN84	BKR4E	RC12YC	BP5EVX	N9YC
B6HS10	OE037	B105EGV	QN84	BKR5EN11	OE039	BP5EVX	OE001
B6HSA	L86C	BCP5E	C9YCC	BKR5EN11	RC9YC4	BP5HS	L92YC
B6HSA	OE037	BCP5E	OE023	BKR5EY	OE005	BP5HS	OE059
B6HVX	L86C	BCP5EV	C9YCC	BKR5EY	RC9YC	BP5S	J12YC
B6HVX	OE037	BCP5EV	OE023	BKR6E	OE005	BP6E	N9YC
B6L	H8C	BCP5EVX	C9YCC	BKR6E	RC9YC	BP6E	OE001
B6S	J8C	BCP5EVX	OE023	BKR6EIX	OE179	BP6ES	N9YC
B7EB	N4C	BCP6E	C9YCC	BKR6EIX	RC8WYP4	BP6ES	OE001
B7EB	OE079	BCP6E	OE023	BKR6EIX11	OE179	BP6ESZ	N9YC
B7ECS	OE018	BCP6ES	C9YCC	BKR6EIX11	RC8WYP4	BP6ESZ	OE001
B7ECS	RN7YC	BCP6ES	OE023	BKR6EK	OE026	BP6EVG4	N9YC
B7ES	N4C	BCP6EV	C9YCC	BKR6EK	RC8DMC	BP6EVG4	OE001
B7ES	OE079	BCP6EV	OE023	BKR6EK11	OE026	BP6EY	N9YC
B7EV	N4C	BCP6EVX	C9YCC	BKR6EK11	RC8DMC	BP6EY	OE001
B7EV	OE079	BCP6EVX	OE023	BKR6EK11	OE026	BP6HS	L82YC
B7EVX	N4C	BCP7ES	C7YC	BKR6EK11	RC8DMC	BP6HS	L87YC
B7EVX	OE079	BCP7ES	OE017	BKR6EKE	OE026	BP6HS	OE007
B7HS	L82C	BCPR4ES	OE013	BKR6EKE	RC8DMC	BP6HS	OE038
B7HS10	L82YC	BCPR4ES	RC12YC	BKR6EKPA	OE026	BP6HS10	L87YC
B7HS10	OE038	BCPR5E11	OE039	BKR6EKPA	RC8DMC	BP6HS10	OE007
B8ECS	N2C	BCPR5E11	RC9YC4	BKR6EKPB11	OE026	BP6HSA	L82YC
B8ECS	OE040	BCPR5ES	OE005	BKR6EKPB11	RC8DMC	BP6HSA	L87YC
B8EG	N3G	BCPR5ES	RC9YC	BKR6EKVP4	OE026	BP6HSA	OE007
B8EG	OE078	BCPR5ES11	OE039	BKR6EKVP4	RC8DMC	BP6HSA	OE038
B8EGP	N3G	BCPR5ES11	RC9YC4	BKR6ES	OE043	BP6S	J12YC
B8EGP	OE078	BCPR5EY	OE005	BKR6ES	RC7YC	BP7ES	N7YC
B8EGV	N3G	BCPR5EY	RC9YC	BKR6EVX	OE014	BP7ES	OE010
B8EGV	OE078	BCPR5EY11	OE039	BKR6EVX	RC7YCC	BP7EVX	N7YC
B8ES	N2C	BCPR5EY11	RC9YC4	BKR7E	OE043	BP7EVX	OE010
B8ES	N3C	BCPR5EYN11	OE039	BKR7E	RC7YC	BP7EY	N7YC
B8ES	OE040	BCPR5EYN11	RC9YC4	BKR7EIX	OE179	BP7EY	OE010
B8ES	OE068	BCPR6E	OE005	BKR7EIX	RC8WYP4	BP7HS	L82YC
B8EV	N3G	BCPR6E	RC9YC	BKR7EKC	OE026	BP7HS	L87YC
B8EV	OE078	BCPR6EIX11	OE179	BKR7EKC	RC8DMC	BP7HS	OE007
B8EVX	N3G	BCPR6EIX11	RC8WYP4	BKR7EKC	OE026	BP7HS	OE038
B8EVX	OE078	BCPR6ES	OE005	BKR7EKC	RC8DMC	BP7HS10	L82YC
B8HCS	L78C	BCPR6ES	RC9YC	BKR7EVX	OE014	BP7HS10	OE038
B8HS	L78C	BCPR6ES11	OE039	BKR7EVX	RC7YCC	BP8ES	N6YC
B8HVX	L77JC4	BCPR6ES11	RC9YC4	BM4A	CJ14	BP8ES	OE087
B8S	J4C	BCPR6ESVP4	OE005	BM6A	CJ8	BP8EVX	N3G
B9EG	N2G	BCPR6ESVP4	RC9YC	BM7A	CJ6	BP8EVX	OE078
B9EG	OE125	BCPR6ET	OE021	BMR2A	CJ14	BP8HN10	L78YC
B9EGV	N2G	BCPR6ET	OE077	BMR4A	CJ14	BP8HS	L82YC
B9EGV	OE125	BCPR6ET	RC7BMC	BMR6A	RCJ8	BP8HS	OE038
B9ES	N2C	BCPR6ET	RC7BYC4	BMR7A	CJ6	BP8HS10	L82YC
B9ES	OE040	BCPR6EYN11	OE039	BP2E	RN14YC	BP8HS10	OE038
B9EV	N2C	BCPR6EYN11	RC9YC4	BP2ES	RN14YC	BP8HS15	L82YC
B9EV	OE040	BCPR7E	OE043	BP4	RJ14YC	BP8HS15	OE038
B9EVX	N2G	BCPR7E	RC7YC	BP4ES	N11YC	BPM6A	CJ8Y
B9EVX	OE125	BCPR7ER	OE013	BP4ES	OE065	BPM7A	CJ7Y
B9HCS	L77JC4	BCPR7ER	RC12YC	BP4EY	N12YC	BPM7Y	CJ7Y
B9HS	L77JC4	BCPR7ES	OE014	BP4EY	OE015	BPMR4A	RCJ8Y
B9HS10	L77JC4	BCPR7ES	OE043	BP4HS	L92YC	BPMR6A	RCJ7Y
B9HVX	L77JC4	BCPR7ES	RC7YC	BP4HS	OE059	BPMR6Y	RCJ8
B10EG	N2C	BCPR7ES	RC7YCC	BP5E	N9YC	BPMR7A	RCJ7Y
B10EG	OE040	BCPR7ET	OE043	BP5E	OE001	BPMR7Y	RCJ7Y
B10EGV	N2G	BCPR7ET	RC7YC	BP5EAL	N11YC	BPMR8Y	RCJ6Y
B10EGV	OE125	BCPR7EY	OE043	BP5EAL	OE065	BPR2E	RN14YC
B10ES	C57	BCPR7EY	RC7YC	BP5ES	N9YC	BPR2ES	RN14YC
B10EV	N2G	BE529Y11	OE156	BP5ES	N11YC	BPR4ES	OE042
B10EV	OE125	BE529Y11	RN13LYC	BP5ES	N12YC	BPR4ES	RN12YC
B10EVX	N2G	BK5ESZ	OE026	BP5ES	OE001	BPR4ES11	OE049
B10EVX	OE125	BK5ESZ	RC8DMC	BP5ES	OE015	BPR4ES11	RN11YC4
B10HS	QL55	BK6E11	C7YC	BP5ES	OE065	BPR4ESL11	OE049
B10HV	QL55	BK6E11	OE017	BP5ESA	N12YC	BPR4ESL11	RN11YC4





...NGK	CHAMPION	...NGK	CHAMPION	...NGK	CHAMPION	...NGK	CHAMPION
BPR4EVX	OE042	BPR7EVG4	OE008	BR9EVX	OE091	D7EVX	OE112
BPR4EVX	RN12YC	BPR7EVG4	RN7YCC	BR9EVX	RN2C	D8EA	8809
BPR4EY11	OE049	BPR7EY	OE018	BR9EYA	OE091	D8EV	A6GC
BPR4EY11	RN11YC4	BPR7EY	RN7YC	BR9EYA	RN2C	D8EV	OE112
BPR4FS	RV15YC4	BPR7HS	OE064	BR9HS	QL77JC4	D8EVX	A6GC
BPR4FS11	RV15YC4	BPR7HS	RL82YC	BR9HS10	QL77JC4	D8EVX	OE112
BPR4HS	RL95YC	BPR7HS10	OE064	BR10ECMVX	QN84	D9EA	RAX92C
BPR4S	RJ18YC	BPR7HS10	RL82YC	BR10EG	RN57YCC	D9EV	A59C
BPR5E	OE006	BPR8ES	OE116	BR10EIX	RN1C	D9EVX	RAX92C
BPR5E	RN9YC	BPR8ES	RN6YC	BR10ES	RN1C	DCPR6E	RA8HC
BPR5EA11	OE045	BPR8HS	OE064	BR10ET	QN84	DCPR7E	OE083
BPR5EA11	OE048	BPR8HS	RL82YC	BR10EV	QC57	DCPR7E	RA6HC
BPR5EA11	RN9YC4	BPR9ES	RN57YCC	BZ7HS10	QL77JC4	DCPR7E	RA8HC
BPR5EA11	RN11YCC	BPR9EVX	RN57YCC	C6HSA	Z9Y	DCPR7EIX	OE083
BPR5EAL	OE006	BPSESZ	N11YC	C7E	G59C	DCPR7EIX	RA6HC
BPR5EAL	RN9YC	BPSESZ	OE065	C7HSA	Z9Y	DCPR7EVX	OE083
BPR5EAL11	OE048	BR2LM	RJ19LM	C8E	G59C	DCPR7EVX	RA6HC
BPR5EAL11	RN9YC4	BR4ES	RN5C	C8E	G63	DCPR8E	OE052
BPR5EP11	N9YC	BR4HS	RL86C	C8EH9	RGU94C	DCPR8E	OE083
BPR5EP11	OE001	BR4LM	RJ17LM	C8HSA	Z9Y	DCPR8E	RA4HCX
BPR5ES	OE006	BR5ES	RN5C	C9E	G55C	DCPR8E	RA6HC
BPR5ES	OE051	BR5HS	RL86C	C9E	G57C	DCPR8EA	OE083
BPR5ES	RN9YC	BR6EB	RN5C	CPR6EA9	RG6YC	DCPR8EA	RA6HC
BPR5ES	RN11YC	BR6ES	RN5C	CPR6EB9	RG6YCA	DCPR8EKC	OE052
BPR5ES11	OE048	BR6HS	RL86C	CPR8E	RG6YC	DCPR8EKC	RA4HCX
BPR5ES11	OE049	BR6HS10	RL86C	CPR8EA9	8698	DCPR9E	OE073
BPR5ES11	RN9YC4	BR6HSA	RL86C	CPR8EA9	RG94C	DCPR9E	RA4HC
BPR5ES11	RN11YC4	BR6S	RJ8C	CPR9EA9	OE092	DCPR9EVX	OE073
BPR5ES15	OE048	BR7EB	OE098	CPR9EA9	RG4HC	DCPR9EVX	RA4HC
BPR5ES15	RN9YC4	BR7EB	RN4C	CR4HSB	Z9Y	DIMR8A10	RG94C
BPR5EY	OE006	BR7ES	OE098	CR5HS	Z9Y	DP7EA9	A6HC
BPR5EY	RN9YC	BR7ES	RN4C	CR5HSB	Z9Y	DP7EA9	OE132
BPR5EY11	OE048	BR7HIX	OE086	CR6E	RG96C	DP9EA9	8809
BPR5EY11	RN9YC4	BR7HIX	RL82C	CR7E	RG96C	DP9EA9	RAX92YC
BPR5FS	RV15YC4	BR7HS	OE086	CR7EB	RG96C	DP9EA9	RA8HC
BPR5HS	RL95YC	BR7HS	RL82C	CR7EKA	RZ96C	DP9EA9	8812
BPR6E	OE006	BR7HS10	OE086	CR7EKB	RG6YC	DP9EA9	8809
BPR6E	RN9YC	BR7HS10	RL82C	CR7HS	RZ96C	DP9EA9	OE073
BPR6EKN	OE018	BR7HS10/BR7HS	OE086	CR7HSA	RZ96C	DP9EA9	RA4HC
BPR6EKN	RN7YC	BR7HS10/BR7HS	RL82C	CR8E	RG94C	DP9EA9	OE083
BPR6ES	OE004	BR8ECM	QN86	CR8EB	RG94C	DP9EA9	RA6HC
BPR6ES	OE006	BR8ECMVX	QN86	CR8EH9	RGU94C	DP9EA9	8809
BPR6ES	RN9YC	BR8EG	OE108	CR8EH9S	RGU94C	DP9EA9	RAX92YC
BPR6ES	RN9YCC	BR8EG	RN3C	CR8EHVX9	RGU94C	DP9EV9	OE073
BPR6ES11	OE048	BR8EIX	8904	CR8EIB10	RG94C	DP9EV9	RA4HC
BPR6ES11	RN9YC4	BR8ES	OE108	CR8EK	8698	DP9Z	OE073
BPR6EVG	OE004	BR8ES	RN3C	CR8EK	RG94C	DP9Z	RA4HC
BPR6EVG	RN9YCC	BR8ES11	OE108	CR8EVX	RG94C	DR6HS	P8Y
BPR6EVG4	OE004	BR8ES11	RN3C	CR8HS	RZ94C	DR7EA	OE083
BPR6EVG4	RN9YCC	BR8EV	OE108	CR8HSA	RZ94C	DR7EA	RA6HC
BPR6EY	OE006	BR8EV	RN3C	CR8HVX	RZ94C	DR7ES	OE083
BPR6EY	RN9YC	BR8EVX	OE108	CR9E	8654	DR7ES	RA6HC
BPR6EY11	OE048	BR8EVX	RN3C	CR9EB	8654	DR8EA	8809
BPR6EY11	RN9YC4	BR8HCS10	8883	CR9EIA9	OE122	DR8EB	8809
BPR6H	OE064	BR8HIX	8883	CR9EIA9	RG4PHP	DR8ES	RAX92C
BPR6H	RL82YC	BR8HS	RL78C	CR9EIX	OE122	DR9EA	8809
BPR6HIX	OE064	BR8HS10	RL78C	CR9EIX	RG4PHP	DR9EA	RAX92C
BPR6HIX	RL82YC	BR8HSA	RL78C	CR9EK	8654	FR2A-D	OE042
BPR6HS	OE064	BR9ECM	QN84	CR9EKB	8654	FR2A-D	RN12YC
BPR6HS	RL82YC	BR9ECS	OE091	CR9EKPA	8654	FR4	OE013
BPR6HS10	OE064	BR9ECS	RN2C	CR10EK	8654	FR4	RC12YC
BPR6HS10	RL82YC	BR9EG	OE091	D6EA	RA8HC	GR4	OE042
BPR6HSA	RL87YC	BR9EG	RN2C	D7EA	A6HC	GR4	RN12YC
BPR7E	OE018	BR9EIX	8904	D7EA	OE132	GR55	OE048
BPR7E	RN7YC	BR9ES	OE091	D7ES	A6HC	GR55	RN9YC4
BPR7ES	OE008	BR9ES	RN2C	D7ES	OE132	IFR6J11	OE179
BPR7ES	OE018	BR9ET	QN84	D7EV	A6GC	IFR6J11	RC8WYP4
BPR7ES	RN7YC	BR9EV	OE091	D7EV	OE112	IFR6S	OE179
BPR7ES	RN7YCC	BR9EV	RN2C	D7EVX	A6GC	IFR6S	RC8WYP4



...NGK		
JR8B	8809	
JR9B	8809	
JR9B	RAX92DC	
KR9CI	OE073	
KR9CI	RA4HC	
LB05E	SRO-5U	
LB05F	PRO-5M	
LR8B	RZ94C	
PFR7ZTG	RC7PYCBX	
PGR5A	OE042	
PGR5A	RN12YC	
PGR5C11	OE042	
PGR5C11	RN12YC	
PGR6A	OE018	
PGR6A	RN7YC	
PKR9B	OE073	
PKR9B	RA4HC	
PMR7A	OE122	
PMR7A	RG4PHP	
PMR8A	OE122	
PMR8A	RG4PHP	
PMR8B	OE122	
PMR8B	RG4PHP	
R017-8	G63	
R0045J-10	G54V	
R0045J-11	G54V	
R2270	QA55V	
R2349	QA55V	
R4118S-95	QN84	
R6021E-95	QN84	
R6252E-9	QN84	
R6252K-105	QC57	
R6254E-105	QC57	
R6918B-8	OE108	
R6918B-8	RN3C	
R7376-10	QN84	
SD05F	PRO-5U	
SD05FM	PRO-5U	
SD05FP	PRO-5U	
TR5A10	OE031	
TR5A10	RES9YCC4	
TR5B13	OE031	
TR5B13	RES9YCC4	
TR5F13	OE031	
TR5F13	RES9YCC4	
V32	OE005	
V32	RC9YC	
XR4	RJ18YC	
ZFR6A	OE005	
ZFR6A	RC9YC	
ZFR6K11	OE026	
ZFR6K11	RC8DMC	
ZGR5A	OE060	
ZGR5A	RN9LCC	
ZGR5B	OE060	
ZGR5B	RN9LCC	
ZGR5C	OE156	
ZGR5C	RN13LYC	
PAL		
Super.L7Y	N11YC	
Super.L7Y	OE065	
Super.N7	L86C	
Super.N7	OE037	
Super.N7Y	L87YC	
Super.N7Y	OE007	
Super.N8	L82C	

...PAL		
Super.N8Y	L82YC	
Super.N8Y	OE038	
PEUGEOT		
5962.16	N9YC	
5962.16	OE001	
5962.65	N9YC	
5962.65	OE001	
5962.90	L87YC	
5962.90	OE007	
5962.94	N7YC	
5962.94	OE010	
5962.95	N7YC	
5962.95	OE010	
5962.96	L82C	
5962.C6	C9YCC	
5962.C6	OE023	
5962.F8	C9YCC	
5962.F8	OE023	
5962.G8	N7YC	
5962.G8	OE010	
5962.H5	L92YC	
5962.H5	OE059	
5962.H6	OE043	
5962.H6	RC7YC	
5962.K1	OE014	
5962.K1	RC7YCC	
5962.K7	OE021	
5962.K7	RC7BMC	
5962.C6	C9YCC	
5962.C6	OE023	
5962F8	C9YCC	
5962F8	OE023	
5962G8	N7YC	
5962G8	OE010	
5962H5	L92YC	
5962H5	OE059	
5962H6	OE043	
5962H6	RC7YC	
5962K1	OE014	
5962K1	RC7YCC	
5962K7	OE021	
5962K7	RC7BMC	
596216	N9YC	
596216	OE001	
596265	N9YC	
596265	OE001	
596288	N6YC	
596288	OE087	
596289	N6YC	
596289	OE087	
596290	L87YC	
596290	OE007	
596294	N7YC	
596294	OE010	
596295	N7YC	
596295	OE010	

PIAGGIO		
P1M	N1C	
P2M	N2C	
P2M	OE040	
P4M	N4C	
P4M	OE079	
P82M	L82C	
P86M	L86C	
P86M	OE037	
RP1M	RN1C	
RP2M	OE091	
RP2M	RN2C	
RP4HM	OE092	
RP4HM	RG4HC	
PROTON		
MS851237E	OE039	
MS851237E	RC9YC4	
SEV MARCHAL		
4N	L82C	
34S	L82C	
SOGEDAC		
CF11	C9YCC	
CF11	OE023	
CP10	N9YC	
CP10	OE001	
XP4	N6YC	
XP4	OE087	
XP6	N7YC	
XP6	OE010	
XP10	N9YC	
XP10	OE001	
XPC7	L86C	
XPC7	OE037	
STITT		
407L	OE086	
407L	RL82C	
407XL	OE039	
407XL	RC9YC4	
R407L	OE086	
R407L	RL82C	
R407XL	OE039	
R407XL	RC9YC4	
TORCH		
A6TC	Z9Y	
A7RTC	Z9Y	
A7TC	Z9Y	
D6RTC-9	RA8HC	
D7RTC-9	8812	
D8RTC	8809	
F6RTC	OE006	
F6RTC	RN9YC	
F6TC	N7YC	
F6TC	OE010	
L6RTC	RCJ7Y	
L6TC	CJ8Y	

...TORCH		
L7RTC	RCJ7Y	
L7T	CJ8	
L7TC	CJ7Y	
TT137C	Z9Y	
UNIPART		
GSP2002	OE004	
GSP2002	OE006	
GSP2002	RN9YC	
GSP2002	RN9YCC	
GSP2003	OE005	
GSP2003	RC9YC	
GSP2005	OE039	
GSP2005	RC9YC4	
GSP2007	C7YC	
GSP2007	OE017	
GSP2009	N7YC	
GSP2009	OE010	
GSP2024	N6YC	
GSP2024	OE087	
GSP2029	OE064	
GSP2029	RL82YC	
GSP2116	OE043	
GSP2116	RC7YC	
GSP4256	L82C	
GSP4256	L82YC	
GSP4256	OE038	
GSP4266	L86C	
GSP4266	OE037	
GSP4342	N6YC	
GSP4342	OE087	
GSP4347	N6BYC	
GSP4347	OE109	
GSP4352	N7YC	
GSP4352	OE010	
GSP4356	L82YC	
GSP4356	OE038	
GSP4362	N9YC	
GSP4362	OE001	
GSP4366	L87YC	
GSP4366	OE007	
GSP4372	N11YC	
GSP4372	OE065	
GSP4376	L92YC	
GSP4376	OE059	
GSP4382	N12YC	
GSP4382	OE015	
GSP4452	OE018	
GSP4452	RN7YC	
GSP4456	OE064	
GSP4456	RL82YC	
GSP4462	OE006	
GSP4462	RN9YC	
GSP4472	OE051	
GSP4472	RN11YC	
GSP4482	OE042	
GSP4482	RN12YC	
GSP4552	C7YC	
GSP4552	OE017	
GSP4652	OE043	
GSP4652	RC7YC	
GSP4657	OE021	
GSP4657	RC7BMC	
GSP4662	OE005	
GSP4662	RC9YC	
GSP6452	OE008	
GSP6452	RN7YCC	



**...UNIPART**

GSP6462	OE004
GSP6462	RN9YCC
GSP6472	OE045
GSP6472	RN11YCC
GSP6651	OE031
GSP6651	RES9YCC4
GSP6652	OE014
GSP6652	RC7YCC
GSP46522	OE026
GSP46522	RC8DMC

VAG

101.000.007.AA	N6BYC
101.000.007.AA	OE109

VALEO

4N	L82C
5N	L87YC
5N	OE007
6N	L86C
6N	OE037
7H	N6YC
7H	OE087
8H	N9YC
8H	OE001
9H	N11YC
9H	OE065
64H	N6YC
64H	OE087
64Hb	N6YC
64Hb	OE087
67HP	N3G
67HP	OE078
70H	N7YC
70H	OE010
70Hb	N7YC
70Hb	OE010
76H	N9YC
76H	OE001
76Hb	N9YC
76Hb	OE001
84H	N9YC
84H	OE001
84Hb	N9YC
84Hb	OE001
88H	L87YC
88H	OE007
88Hb	L87YC
88Hb	OE007
F70H	C7YC
F70H	OE017
F70H/F70Hb	C7YC
F70H/F70Hb	OE017
F70Hb	C7YC
F70Hb	OE017
F72H	C7YC
F72H	OE017
F72H/F72Hb	C7YC
F72H/F72Hb	OE017
F72H3	OE021
F72H3	RC7BMC
F72Hb	C7YC
F72Hb	OE017
F74H	C7YC
F74H	OE017

...VALEO

F74H/F74Hb	C7YC
F74H/F74Hb	OE017
F74Hb	C7YC
F74Hb	OE017
RF74H	OE043
RF74H	RC7YC
RF74H3	OE021
RF74H3	RC7BMC

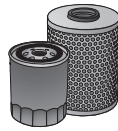

APRILIA	
0256187	X312
0256450	X325
256185	X305
8102582	Y318
8102715	V300
8560153	C316

BENELLI	
0180107101000	F310
61150000	X315

BETA	
3532170000	X319
3625185000	X335
3625361000	X320

BMW	
11001300053	C312
11009056145	X332
11009056146	X333
11011341616	C313
11412343452	X305
11421337570	X317
11421337575	X316
11421460697	C301 / C313
11421460833	C301
11421460845	C301
11427673541	C325
13711341528	V302
13712345232	U309
13722345027	Y316

BOMBARDIER	
420256621	C322
420956741	X347
711256620	C322
711956740	X347
711956741	X347

CAGIVA	
41152001A	C302
800064754	U303
800071573	U302
800096226	K301

DUCATI	
037098610	U301
075949890	X331
42540021A	L301
42540061A	L300
42610091A	U301
44440034A	H301
90549960	H301

FIAAM	
PA7059	U301

FRAM	
CH4780	X301
CH4781	X303
CH4781	X315
CH4782	X304
CH4783	X307
CH4786	X302
CH4787	X311
CH4837	X306
PH6010	F302
PH6011	C306
PH6016	C303
PH6017	F301
PH6018	K301

FUJI	
OFE001	X303
OFE001P	X315
OFE002	X304
OFE004	F302
OFE005	X301
OFE006	F302
OFE009	X314
OFE010	X310
OFE012	X323
OFE012A	X309
OFE015	X308
OFE017	X302
OFE018	X306
OFE019	X311
OFE020	F302
OFE022	X313
OFE023	C303
OFE024	F301
OFE025	K301
OFE026	F301
OFE030	F302
OFE032	F301
OFE033	F301

GILERA	
321205	C302

GUZZI	
14153000	H302
19053099	X318
19153000	X318
27153085	X329
28113650	U300
28113660	U300
30113660	U307
30153000	C305

HAMANA	
101	X303
103	F302
104	X301
105	X304
106	F301
107	X302
108	X306
109	X311
110	X307
112	C303
113	K301
114	X314
115	X310

HARLEY DAVIDSON	
63805-80	C306
63810-80	H301
63813-90	C307

HIFLO	
HF111	X304
HF112	X301
HF113	X356
HF116	X357
HF132	X355
HF138	K301
HF141	X354
HF145	X302
HF148	F306
HF151	X305
HF152	X312
HF164	C325
HF183	C320
HF184	C316
HF185	X325
HF191	F308
HF198	F306
HF204	F308
HF553	F310
HF556	X347
HF557	C322
HFA1602	Y341
HFA1603	J343
HFA1609	J341
HFA1615	J345
HFA1801	J346
HFA1906	Y339
HFA1908	Y340
HFA1909	J342
HFA1912	J338
HFA2502	Y342

HIFLO	
HFA2503	J335
HFA2602	J337
HFA2910	Y337
HFA2911	X338
HFA2914	J336
HFA1910	J339
HFA3602	Y336
HFA3609	Y334
HFA3610	J333
HFA3705	Y335
HFA3903	J332
HFA3908	J334
HFA4603	Y326
HFA4606	Y327
HFA4610	Y331
HFA4906	Y328
HFA4907	Y325
HFA4908	Y329
HFA4909	Y324
HFA4910	Y330

HONDA	
15410-422-000	X315
15410-426-000	X315
15410-426-010	X303
15410-KFO-305	X301
15410-KFO-315	X301
15410-MB0-003	F302
15410-MCJ-000	F308
15410-MJ0-003	F302
15410-MJ0-405	F302
15410-MM9-P00	F301
15410-MM9-P01	F301
15412-300-024	X303
15412-300-325	X315
15412-413-005	X304
15412-HM5-A10	X356
15412-KFO-000	X301
15412-KFO-010	X301
15412-KFO-020	X301
15412-MEB-671	X349
15412-MEN-671	X357
15412-MM2-671	X304
154A1-413-005	X322
17205-MN5-003	J338
17205-MR1-000	J328
17210-KT8-000	J326
17210-MAT-000	J339
17210-MAT-E01	J340
17210-MBG-000	J346
17210-MBL-D00	J341
17210-MBT-D10	J342
17210-MBW-000	J343
17210-MCB-610	J345
17210-MCB-960	J345
17210-MCW-D00	J346
17210-MN8-000	J324
17210-MV9-000	J308
17210-MV9-003	J308
17210-MW0-000	J315
17211-413-000	Y317
17211-425-000	J306
17211-MG9-000	Y339
17211-MM5-000	J316
17211-MW3-700	J317
17213-MW2-780	V312
17215-MM8-020	Y340





...HONDA	
17220-415-003	V313
17230-KEA-010	Y341
17230-MM9-000	J307
17230-MY1-000	J314
17230-MY9-000	J301

HUSQVARNA	
800081675	X337

KAWASAKI	
11013-1013	J305
11013-1027	Y313
11013-1112	J323
11013-1122	Y307
11013-1139	Y319
11013-1152	Y314
11013-1154	Y308
11013-1157	J320
11013-1227	Y312
11013-1235	Y337
11013-1240	Y310
11013-1244	Y311
11013-1248	Y338
11013-1252	J335
11013-1261	Y342
11013-1270	J336
11013-1274	J337
16097-1054	F302
16097-1061	F306
16097-1063	F306
16097-1064	F304
16097-1064	F306
16097-1066	F306
16097-1068	F308
160971070	F308
16099-002	X314
16099-003	X303
16099-003	X321
16099-004	X310
52010-0001	X351
52010-1053	X301
52010-S005	K301

KNECHT/MAHLE	
LX578	V302
OC11	C302
OC224	F303
OC5	H301
OC91	C301
OX102	X305
OX115	X320
OX119	X305
OX129	X325
OX36	X316
OX37	X317
OX61	X303

KTM	
50306015000	Y301
56506015100	Y300
58038005000	X320
58338045000	F303
58406015000	Y315
59038046000	X335
6256180	X305

LAVERDA	
2001000027	U306
62001000025	C302
62001V01109	U305

MEIWA	
H1001	X303
H1002	X315
H1003	X315
H1004	X315
H1005	X304
H1007	F302
H1008	X301
H1009	F302
H1011	X322
H1012	X304
H1013	F301
H1014	F301
H1112	J306
H1114	Y317
H1115	V313
H1166	J316
H1167	J307
H1174	V312
H1178	J308
H1179	J317
H1180	J315
K2001	X314
K2002	X310
K2004	X303
K2005	F302
K2007	F301
K2008	F301
K2105	J305
K2118	Y313
K2121	J323
K2124	Y314
K2125	Y308
K2127	Y307
K2132	J320
K2136	Y319

...MEIWA	
K2141	Y312
S3002	X309
S3006	X308
S3007	C303
S3009	K301
S3140	J322
S3142	Y304
S3145	Y320
S3149	J303
S3150	V304
S3152	J304
Y4001	X302
Y4002	X306
Y4003	X311
Y4005	X303
Y4006	X313
Y4007	F301
Y4008	F301
Y4105	Y306
Y4112	J319
Y4113	J300
Y4117	Y305
Y4122	Y303
Y4126	J310
Y4128	V311
Y4130	Y321
Y4140	V303
Y4141	V305
Y4152	U304
Y4153	J302

MUZ	
8156180	X320
9020205	X302

PERF.FORM	
HD2	C306
HD-3	H301
HO-1	F302
JA-1	X303

PIAGGIO	
410229	X330
436478	Y309
483727	C320
82635R	C320
830239	C316

PUROLATOR	
L17601	H301
L27211	C301

SUZUKI	
13780-01D00	J303
13780-02FA0	J332
13780-12D00	Y304
13780-17C00	J321
13780-17E00	J304
13780-19C00	J322
13780-20C00	Y336
13780-20F00	Y334
13780-21E00	J325
13780-24B01	U308
13780-31F00	J333
13780-33E00	Y335
13780-33E01	Y335
13780-35F00	J334
13780-38A01	V310
13780-38A51	J313
13780-45500	V307
13780-45C10	V304
13781-34C10	Y302
13781-38B50	Y320
16500-45810	X323
16500-45820	X309
16510-03G00-X07	K301
16510-05240	X327
16510-05-A00	C303
16510-06-B00	K301
16510-06-B01	K301
16510-24501	X328
16510-29-F00001	X345
16510-34-E00000	K301
16510-37440	X308
16510-37450-000	X308
16510-38240	X319
16510-45040	X307
16510-45040	X323

TRIUMPH	
T1210200	F308
T1210440	F308
T1210444	F308

UFI	
23.105.00	H301
23.118.00	C302
23.131.00	C305
23.131.01	C303
23.149.00	H302
23.184.00	F302
23.224.00	C301
23.287.00	C305
25.405.00	X318
25.471.00	X303
25.471.00	X315
25.498.00	X309
25.498.00	X323
25.498.01	X309
25.514.00	X302
25.515.00	X311
25.517.00	X304
25.524.00	X310
25.526.00	X316
25.527.00	X317
25.531.00	X329
25.542.00	X301
25.553.00	X305

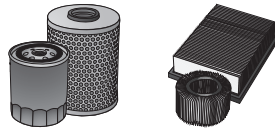

...UFI	CHAMPION
25.554.00	X320
25.588.00	X337
27.240.00	V300
30.010.00	U302
30.814.00	U300
30.886.00	U300
30.957.00	U303
30.983.00	U301

VESRAH	CHAMPION
SF1001	X303
SF1002	X304
SF1004	F302
SF1005	X301
SF1007	F301
SF2001	X306
SF2002	X311
SF2003	X302
SF2004	X313
SF3001	X323
SF3002	X309
SF3004	X309
SF3005	X308
SF3006	X319
SF3008	C303
SF3009	K301
SF4001	X314
SF4002	X310
SF4004	X315
SF4005	F301

YAMAHA	CHAMPION
1AE-14451-00	V311
1FK-14451-00	Y330
1J7-13440-91	X311
1L9-13440-91	X306
1L9-13441-11	X306
1UY-13440-0200	X348
1WG-14451-00	V303
29L-14451-00	Y303
2CO 14450 0100	Y333
2GV-14451-00	V305
31A-14451-00	J312
33M-14451-00	J310
36Y-13441-00	X303
36Y-14451-00	J311
3FV-13440-00	F306
3GM-14451-00	V306
3LD-14450 00	J327
3TB-14451-01	U304
3YF-14451-00	J302
42X-14451-00	J309
47X-14451-00	Y321
4BH-14451-0000	Y324
4BR-14451-0000	Y326
4FM-14451-00	J318
4H7-14451-00	J300
4JH-14451-00	V309
4KG-14451-0000	Y328
4NK-14451-0000	Y329
4TR-14451-00	V308
4X7-13440-90	X302
4X7-14451-00	J319
4XV-14451-0000	Y325
4YR-14451-0100	Y327

...YAMAHA	CHAMPION
583-14451-09	Y306
5CHE44500000	J330
5DM-13440-00	F307
5EB-14450-0100	Y331
5GH-13440-0000	F306
5HO-13440-09	X313
5HO-13440-00	X313
5JW-13440-0000	F306
5JX-13440-0000	X302
5PS-14451-0000	J331
5RU-13440-0000	X355
5SL-14450-0000	Y332
5TA-13440-0000	X354
5VX-14451-0000	J329
5Y1-14451-00	Y305
JEB-13440-00	F306